



EGLO
my light | my style



2023/24

INTERIOR LIGHTING

WOHNRAUMLEUCHTEN
LUMINAIRES INTÉRIEURS



Dear business partners and loyal EGLO friends,

We are thrilled to present our new main EGLO catalogue. With this catalogue, we want to showcase our extensive collection of high-quality luminaires, designed with meticulous attention to detail and a focus on design and quality.

At EGLO, environmental sustainability is a top priority. We ensure that our luminaires are produced in a way that conserves resources as much as possible. Additionally, the durability of our products is of great importance to us. We want to do our part to guarantee you find beautiful yet sustainable products for your home with EGLO. Many of our luminaires feature energy-saving LED technology, which helps you save on electricity costs and protect the environment.

We take pride in offering a wide range of high-quality luminaires at affordable prices, to ensure you find the perfect fit for your living needs in our catalogue.

We hope you enjoy browsing through our catalogue and look forward to helping you choose the perfect luminaire.

Geschätzte Geschäftspartner*innen, treue EGLO Freund*innen,

wir freuen uns sehr, Ihnen den neuen Hauptkatalog von EGLO präsentieren zu können. Mit diesem Katalog möchten wir Ihnen unsere umfangreiche Kollektion von hochwertigen Leuchten vorstellen, die wir mit viel Liebe zum Detail und einem besonderen Fokus auf Design und Qualität entworfen haben.

Auch das Thema Umwelt spielt bei EGLO eine wichtige Rolle. Wir achten darauf, dass unsere Leuchten möglichst ressourcenschonend produziert werden. Darüber hinaus ist uns die Langlebigkeit unserer Produkte wichtig. Wir möchten unseren Beitrag dazu leisten, dass Sie nicht nur schöne, sondern auch nachhaltige Produkte bei uns finden. Viele unserer Leuchten verfügen über energiesparende LED-Technologie, die Ihnen nicht nur hilft Stromkosten zu sparen, sondern auch die Umwelt schont.

Wir sind stolz darauf, Ihnen eine große Auswahl an hochwertigen Leuchten zu fairen Preisen anbieten zu können und sind uns sicher, dass Sie in unserem Katalog das perfekte Angebot für Ihre Wohnbedürfnisse finden werden.

Wir wünschen Ihnen viel Spaß beim Durchblättern unseres Katalogs und freuen uns darauf, Ihnen bei der Wahl der passenden Leuchte behilflich zu sein.

Chers partenaires commerciaux*, fidèles amis d'EGLO*,

Nous sommes très heureux de vous présenter le nouveau catalogue principal d'EGLO. Avec ce catalogue, nous souhaitons vous présenter notre vaste collection de luminaires haut de gamme, que nous avons conçus avec un grand souci du détail et un accent particulier sur le design et la qualité.

Le thème de l'environnement joue également un rôle important chez EGLO. Nous veillons à ce que nos luminaires soient produits en préservant le plus possible les ressources. De plus, la longévité de nos produits est importante pour nous. Nous souhaitons apporter notre contribution pour que vous trouviez chez nous, non seulement de beaux produits, mais aussi des produits durables. Beaucoup de nos luminaires sont dotés de la technologie LED à faible consommation d'énergie, qui vous permet non seulement d'économiser des frais d'électricité, mais aussi de préserver l'environnement.

Nous sommes fiers de pouvoir vous proposer un grand choix de luminaires de qualité à des prix équitables et nous sommes certains que vous trouverez dans notre catalogue l'offre parfaite pour vos besoins en matière d'habitat.

Nous vous souhaitons beaucoup de plaisir à feuilleter notre catalogue et nous nous réjouissons de pouvoir vous aider à choisir le luminaire qui vous convient.

Mag. René Tiefenbacher
CEO EGLO Group

CONTENT

INHALT
CONTENU



	CONNECT.Z 10 CONNECT.Z CONNECT.Z		SPOT & TRACK LUMINAIRES 678 SPOT- & SCHIENENLEUCHTEN SPOT & LUMINAIRES SUR RAIL
	EGLO ACCESS 112 EGLO ACCESS EGLO ACCESS		CLIP & PLUG LUMINAIRES 772 KLEMM- & STECKERLEUCHTEN LUMINAIRES À PINCE & SUR PRISE
	LIGHTING FAMILIES 130 FABRIC LUMINAIRES STOFFLEUCHTEN LUMINAIRES À TEXTIL		TABLE & FLOOR LUMINAIRES 780 TISCH- & STEHLEUCHTEN LUMINAIRES DE TABLE & LAMPADAIRES
	LIGHTING FAMILIES 206 WOOD LUMINAIRES HOLZLEUCHTEN LUMINAIRES À BOIS		OFFICE TABLE & FLOOR LUMINAIRES 826 OFFICE TISCH- & STEHLEUCHTEN LUMINAIRES DE TABLE & LAMPADAIRES À BUREAU
	LIGHTING FAMILIES 228 STANDARD LUMINAIRES STANDARD LEUCHTEN LUMINAIRES STANDARD		CHILDREN LUMINAIRES 862 KINDERLEUCHTEN LUMINAIRES POUR ENFANTS
	LIGHTING FAMILIES 336 GLASS CHANDELIERS LEUCHTENFAMILIEN FAMILIES DE LUMINAIRES		KITCHEN & FUNCTION LUMINAIRES 868 KÜCHEN- & FUNKTIONSLAUCHTEN LUMINAIRES FONCTIONNELS & DE CUISINE
	HANGING & PENDANT LUMINAIRES 346 HÄNGE- & PENDELLEUCHTEN LUMINAIRES SUSPENSIONS		ACCESSORIES 876 ZUBEHÖR ACCESSOIRES
	WALL & CEILING LUMINAIRES 472 WAND- & DECKENLEUCHTEN APPLIQUES & PLAFONNIERS		INDEX & LEGEND 884 INDEX & ERKLÄRUNG INDEX & LÉGENDE
	BATH & MIRROR LUMINAIRES 616 BAD- & SPIEGELLEUCHTEN LUMINAIRES DE BAIN & MIROIR		

EGLO TREND HIGHLIGHTS 2023/24

The EGLO design team has once again drawn on current mega-trends as a source of inspiration for the 2023/24 season. The new EGLO products' use of shape and colour, choice of materials, and overall aesthetic harmonise perfectly with both contemporary and future living trends. Minimalism and the increasingly popular use of materials and colours such as brass and earth tones have had a particularly strong influence on this season's luminaire designs.

Auf Basis der Megatrends hat sich das Design-Team von EGLO auch für die Saison 2023/24 inspirieren lassen. Mit ihrer Formsprache, Farbgebung sowie den verwendeten Materialien fügen sich die EGLO Neuheiten in die aktuellen wie auch zukünftigen Wohntrends ein. Der Trend des Minimalismus sowie die Verwendung von Materialien und Farben wie Messing und Erdtöne haben auf die aktuellen Leuchten-Designs besonderen Einfluss genommen.

Sur la base des mégatendances, l'équipe de conception EGLO a également été inspirée pour la saison 2023/24. Avec leur langage visuel, leur palette de couleurs et les matériaux utilisés, les innovations EGLO s'intègrent dans les tendances de la vie d'aujourd'hui et de demain. La tendance au minimalisme et l'utilisation de matériaux et de couleurs tels que le laiton et les tons de terre ont eu une influence particulière sur les conceptions actuelles de nos luminaires.

Minimalism – The art of less, the conscious reduction of shapes and colours to the bare essentials, is reflected in our luminaires. Clear and simple shapes and plain colours combine to create a calm atmosphere, in keeping with the maxim "less is more". Warm grey tones and timber elements give the room a welcoming touch, adding atmospheric highlights and offering a harmonious stage for your entire living space to work its magic without any distractions.

Minimalismus – Der bewusste Verzicht und die Kunst, Form und Farbe auf ein Minimum zu reduzieren, spiegelt sich in unseren Leuchten wider. Frei nach dem Prinzip „Weniger ist mehr“ sorgen klare und einfache Formen sowie schlichte Farben für eine ruhige Atmosphäre. Für die nötige Gemütlichkeit setzen warme Grautöne oder Holzelemente stimmungsvolle Akzente und bieten eine harmonische Bühne, um den gesamten Raum ganz ohne Ablenkung für sich wirken zu lassen.

Le minimalisme – Nos lampes reflètent un renoncement volontaire et l'art de réduire au minimum formes et couleurs. Selon le principe « faire plus avec moins », des formes claires et simples et des couleurs unies créent une atmosphère paisible. Pour le confort, des tons gris chauds ou des éléments en bois mettent en place une ambiance agréable et un décor harmonieux pour vous permettre de travailler dans une pièce sans aucune distraction.



ALMUDAINA



CENCIARA

Brass – Brass so popular back in the 50s and 60s, is currently enjoying a new wave of popularity. Skilfully paired with contrasting materials, the gleaming metallic hues of brass bring a touch of luxury to living spaces without appearing old-fashioned. We have incorporated the high-quality material into our new luminaire models and combined it with diverse other materials to create captivating modern designs that can be integrated into a variety of interiors, from urban to classical to minimalist.

Messing – Der bereits in den 50er und 60er Jahren so populäre Messingtrend erfreut sich aktuell an neuer Beliebtheit. Gekonnt kombiniert und kontrastreich in Szene gesetzt, bringt Messing mit seinem strahlenden Metallton einen Hauch von Luxus in die Wohnräume, ohne altmodisch zu wirken. Das hochwertige Material haben wir in unsere neuen Leuchten-Modelle einfließen lassen und in Kombination mit verschiedenen Materialien charmante und moderne Designs geschaffen, die sich in unterschiedliche Einrichtungen von urban über klassisch bis hin zu minimalistisch integrieren lassen.

Le laitton – La tendance du laitton, déjà si populaire dans les années 50 et 60, est actuellement à nouveau au goût du jour. Habilement combiné et mis en scène avec de riches contrastes, le laitton avec sa teinte métallique brillante apporte une touche de luxe aux espaces de vie sans paraître démodé. Nous avons incorporé ce matériau de haute qualité dans nos nouveaux modèles de luminaires et, en combinaison avec divers matériaux, avons créé des designs charmants et modernes qui peuvent être intégrés à des aménagements différents, qu'ils soient notamment urbains, classiques ou encore minimalistes.

Warm earth tones – The very popular back-to-nature trend has also brought about a significant shift in the field of design. More and more people have been embracing a return to nature in recent years and the associated use of natural materials has also left its mark on the world of colour, heralding the rise of brown as the new black. The colour brown in all its many facets can be beautifully paired with almost any other colour and, thanks to its diverse earthy tones, not only lends our living spaces a touch of naturalness, but also conveys a sense of warmth and comfort. Combining this year's popular colour trend with wood and brass elements helps accentuate its distinctive appeal.

Warme Erdtöne – Der starke Trend hin zu mehr Natürlichkeit hat auch im Design einen bedeutsamen Wandel bewirkt. Die in den letzten Jahren deutlich an Bedeutung gewonnene Verbundenheit zur Natur und die damit einhergehende Verwendung von natürlichen Materialien hat auch die Farbwelt geprägt und lässt Braun als das neue Schwarz triumphieren. Braun in all seinen Facetten lässt sich hervorragend kombinieren und verleiht unseren Wohnräumen durch seine vielfältigen Erdtöne nicht nur einen Hauch von Natürlichkeit, sondern vermittelt Gemütlichkeit und Behaglichkeit gleichermaßen. Die Kombination mit Holz oder Messing verleiht der neuen Trendfarbe ihre besonderen Akzente.

Des tons chauds de terre – La forte tendance vers un caractère plus naturel a également entraîné un changement significatif dans notre conception. Le lien avec la nature, qui a grandement gagné en importance ces dernières années, et l'utilisation associée de matériaux naturels ont également façonné l'univers des couleurs : c'est ainsi que le brun a détrôné le noir. Le brun sous toutes ses facettes peut être parfaitement combiné et, avec ses divers tons de terre, non seulement donner à nos salons une touche naturelle, mais aussi procurer confort et bien-être dans le même temps. La combinaison de cette nouvelle couleur tendance avec le bois ou le laiton lui confère ses accents si particuliers.



PODERE

Look out for this Logo!

Achten Sie auf das Logo!

Soyez attentif au logo !

What is a forest?

A peaceful oasis, the green lungs of the world, and an adventure playground for children of all ages!

The Forest Stewardship Council® (FSC®) is a global, not-for-profit organisation dedicated to the promotion of responsible forest management worldwide. The FSC® defines standards for responsible forest management in accordance with established principles that are developed and supported by stakeholders from the environmental, social and economic spheres. For more information, please see www.fsc.org.

Was ist Wald für uns?

Eine Oase der Ruhe, die Lunge der Welt oder ein Abenteuerspielplatz für große und kleine Kinder!

Das Forest Stewardship Council® (FSC®) ist eine globale, gemeinnützige Organisation, mit dem Zweck verantwortungsvolle Waldbewirtschaftung weltweit zu fördern. FSC® definiert Standards für eine verantwortungsvolle Waldbewirtschaftung nach festgelegten Prinzipien, die von Interessenvertretern aus den Bereichen Umwelt, Soziales und Wirtschaft entwickelt und getragen werden. Für weitere Informationen besuchen Sie www.fsc.org.

Que représente la forêt pour nous ?

Une oasis de calme, les poumons du monde ou un terrain de jeu d'aventure pour les enfants de tous âges !

Le Forest Stewardship Council® (FSC®) est une organisation internationale à but non lucratif dont le but est de promouvoir une gestion forestière responsable dans le monde entier. Le FSC® définit des normes de gestion forestière responsable selon des principes établis qui sont développés et soutenus par les parties prenantes des secteurs environnemental, social et économique. Pour plus d'informations, veuillez consulter www.fsc.org.

Look out for FSC® -certified products!
Achten Sie auf FSC® -zertifizierte Produkte!
Soyez attentif aux produits certifiés FSC® !



The mark of
responsible forestry

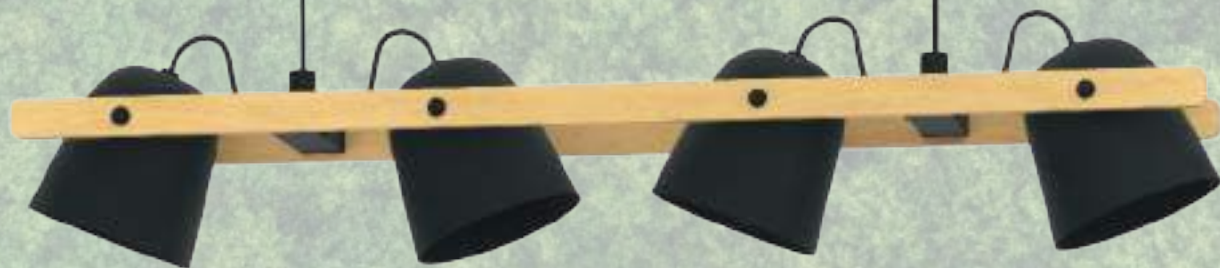

900883



DIGITAL CATALOGUE



This year, we are also making the main catalogue in front of you available online, including lots of extra information and additional features. In addition to search and filter functions, the online catalogue includes extensive product photos, videos and additional information, complementing the paper edition wonderfully. Take a look at

<https://catalogue.eglo.com>

In diesem Jahr präsentieren wir den vor Ihnen liegenden Hauptkatalog wieder als Online-Katalog mit vielen Zusatzinformationen und zusätzlichen Features. Neben Such- und Filterfunktionen bietet der Online-Katalog mit reichhaltigen Produktabbildungen, Videos und zusätzlichen Informationen einen erheblichen Mehrwert zur gebundenen Ausgabe. Klicken Sie sich rein unter

<https://catalogue.eglo.com>

Cette année, nous présentons à nouveau une version en ligne du catalogue général. Cette version contient de nombreuses informations et fonctionnalités complémentaires. Outre les fonctionnalités de recherche et de filtrage, le catalogue en ligne propose de nombreuses illustrations de produits, des vidéos et des informations complémentaires : une valeur ajoutée considérable par rapport à la version papier. Cliquez ici pour le découvrir :

<https://catalogue.eglo.com>



EGLO CONNECT.Z

EGLO CONNECT.Z
EGLO CONNECT.Z

EN EGLO CONNECT.Z

Discover the smart world of light. You will find everything about control options, functions and beneficial use in everyday life on the following pages. Let yourself be surprised by the EGLO connect.z range.

DE EGLO CONNECT.Z

Entdecke die smarte Welt des Lichtes. Alles über Steuerungsmöglichkeiten, Funktionen und die vorteilhafte Anwendung im Alltag finden Sie auf den folgenden Seiten. Lassen Sie sich vom EGLO connect.z Sortiment überraschen.

FR EGLO CONNECT.Z

Découvrez le monde intelligent de la lumière. Vous trouverez tout sur les options de contrôle, les fonctions et l'utilisation bénéfique dans la vie quotidienne dans les pages suivantes. Laissez-vous surprendre par la gamme EGLO connect.z.

connect.2

Discover the smart world













































 zigbee

 Bluetooth®



OVERVIEW

EGLO CONNECT.Z
EGLO CONNECT.Z
EGLO CONNECT.Z

 CONNECT-Z 21	 CONNECT-Z SENSOR 21	 CONNECT-Z SWITCH 21	 ANDREAS-Z 23	 ANCHORENA-Z 24-25	 KOKOMO-Z 26	 HORNWOOD-Z 26	 YUKU-Z 27
 PORTICO-Z 27	 BARBANO-Z 28-29	 ROMAO-Z 30	 TOLLOS-Z 31	 GINESTRONE-Z 33	 SALVILANAS-Z 34-35	 MARGHERA-Z 36-37	 SIMOLARIS-Z 38-39
 FRAIOLI-Z 40-41	 LOBINERO-Z 42	 ZILLERIO-Z 42	 ANDABAIA-Z 43	 TABIANO-Z 44	 LOMALTAS-Z 45	 PARANDAY-Z 46-47	 PARRAPOS-Z 48-49
 CALAGRANO-Z 50-51	 MONTEMORE- LOS-Z 52-53	 GENOVESE-Z 53	 ROVITO-Z 54-57	 PADROGIANO-Z 58-60	 SAVATARILA-Z 62-63	 SALITERAS-Z 63	 TURCONA-Z 64-67
 SARSINA-Z 68-69	 SALOBRENA-Z 70-73	 HERRORA-Z 74	 FUEVA-Z 76-87	 TOTARI-Z 88-89	 LANCIANO-Z 90	 SILERAS-Z 91	 TELIBELA-Z 92-93
 CAMINALES-Z 94	 SALICETO-Z 95	 CAROSSO-Z 96-97	 LED STRIPE-Z 98-99	 LM_LED_E27 100-101	 LM_LED_E14 101	 LM_LED_GU10 101	



This product is available in different colors and shapes. / Dieser Artikel ist in unterschiedlichen Farben und Formen verfügbar. / Cet article est disponible en différentes couleurs et formes.



connect.z combines two control technologies in one system

connect.z vereint zwei Steuerungstechnologien in einem System

connect.z réunit deux technologies de commande au sein d'un même système



ZigBee is far and away the most widely used standard in the smart home world.

ZigBee ist der am weitesten verbreitete Standard in der Smart Home Welt.

ZigBee est le protocole le plus répandu au monde dans le domaine du Smart Home.

ADVANTAGES :

- › Mesh network
- › Direct connection with Amazon Echo and Google Home
- › Compatible with products from different manufacturers
- › High level of security
- › Easy setup
- › Energy efficient

VORTEILE:

- › Mesh-Netzwerk
- › Direkte Verbindung mit Amazon Echo und Google Home
- › Herstellerübergreifend kompatibel
- › Hohe Sicherheit
- › Einfache Einrichtung
- › Energieeffizient

AVANTAGES:

- › Réseau maillé
- › Connexion directe à Amazon Echo et Google Home
- › Compatible indépendamment du fabricant
- › Sécurité élevée
- › Installation facile
- › Économe en énergie

connect.2



Bluetooth is an established standard in the digital world.
Bluetooth ist ein etablierter Standard in der digitalen Welt.
Bluetooth est un standard de communication reconnu dans le monde numérique.

ADVANTAGES:

- › Local & secure network
- › Protocol is mainly audio (low debit)
- › Mesh network: Elements are receivers and senders
- › Easy setup
- › Usable offline
- › Energy efficient

VORTEILE:

- › Lokales & sicheres Netzwerk Protokoll hauptsächlich Audio (Low Debit)
- › Mesh-Netzwerk: Elemente sind Empfänger und Sender
- › Einfache Einrichtung
- › Offline nutzbar
- › Energieeffizient

AVANTAGES:

- › Réseau local et sûr
- › Protocole essentiellement audio (bas débit)
- › Réseau maillé : les éléments sont l'émetteur et le récepteur
- › Installation facile
- › Utilisable hors-ligne
- › Économe en énergie

Light up your world!

Bringen Sie Licht in Ihren Alltag!
Illuminez votre quotidien !



connect.z offers a wide range of lamps and lighting equipment. Select products from the following options according to your needs:
connect.z bietet ein großes Sortiment an Leuchten und Leuchtmitteln. Wählen Sie die Produkte ganz nach Ihren Bedürfnissen aus folgenden Varianten:
connect.z propose une large gamme de luminaires et d'ampoules. Sélectionnez les produits en fonction de vos besoins parmi les variantes suivantes :

Warm White

Neutral White

Tunable White

Individual light from 50,000 white tones.
Individuelles Licht aus 50.000 Weißtönen.
Luminaire individuel à 50 000 tons de blanc.

TW + RGB Colors

Diverse lighting selection from 50,000 white tones and 16 million colours.
Vielseitige Lichtauswahl aus 50.000 Weißtönen und 16 Mio. Farben.
Sélection étendue de luminaires à 50 000 tons de blanc et 16 millions de couleurs.

Enjoy relaxing moments!
Genießen Sie entspannte Momente!
Profitez de moments de détente !

Stay focussed & efficient!
Bleiben Sie konzentriert & leistungsfähig!
Restez concentré(e) et performant(e) !

Start the day fresh every morning!
Starten Sie jeden Morgen frisch in den Tag!
Commencez la journée du bon pied !

Create the perfect atmosphere!
Kreieren Sie Ihr perfektes Ambiente!
Créez votre ambiance parfaite !



Enjoy many useful convenience features: Es erwarten Sie viele nützliche Komfortfunktionen: De nombreuses fonctionnalités utiles vous attendent pour votre confort :



TIMERS AND CALENDARS / TIMER UND ZEITPLÄNE/ MINUTERIE ET CALENDRIER

Make your daily life easier with timers and calendars.
Wake up relaxed with the simulated sunrise.

Unterstützen Sie Ihren Alltag mit Timern und Zeitplänen. Entwickeln Sie eigene Lichtroutinen und machen Sie Ihr Leben leichter.

Facilitez-vous la vie à l'aide de la fonction minuterie et calendrier.
Réveillez-vous en douceur grâce au simulateur de lever de soleil.



LIGHT ALARM CLOCK / LICHTWECKER/ REVEIL LUMINEUX

You'd rather not start your day in a bad mood? Wake up relaxed with the simulated sunrise.

Keine Lust mit schlechter Laune in den Tag zu starten? Entspannt aufwachen mit dem simulierten Sonnenaufgang.

Pas envie de commencer la journée de mauvaise humeur ? Réveillez-vous en douceur grâce au simulateur de lever de soleil.



DISCO FUNCTION/MODE / DISCOFUNKTION/MODUS/ FONCTION/MODE DISCO

For the perfect party mood, the disco function synchronises the light to the beat of your favourite songs.

Für die perfekte Partystimmung schaltet die Discofunktion das Licht passend zum Beat Ihres Lieblingssongs.

Pour une ambiance festive parfaite, la fonction disco enclenche le luminaire au rythme de votre chanson préférée.



PRESENCE SIMULATOR / ANWESENHEITSSIMULATION/ SIMULATEUR DE PRESENCE

Protect your home with the convenient presence simulator. Variable time intervals allow the system to turn the lights on and off to simulate your presence at home and deter unwanted guests.

Schütze Sie Ihr Zuhause mit der komfortablen Anwesenheitssimulation. Dank variabler Zeitintervalle simuliert das System durch Ein- und Ausschalten der Beleuchtung die Anwesenheit im Haus und schreckt so ungebetene Gäste ab.

Protégez votre domicile à l'aide du très pratique simulateur de présence. Le système simule votre présence en allumant et en éteignant les lumières à intervalles variables et décourage ainsi les invités indésirables.



VOICE COMMANDS / SPRACHSTEUERUNG/COMMANDE VOCALE

More convenient! Turn the light on whenever you want with only a voice command.

Noch komfortabler! Mit nur einem Sprachbefehl schaltet sich das Licht nach Ihren Wünschen an und aus.

C'est encore plus confortable ! Allumez votre luminaire comme vous le souhaitez d'une simple commande vocale.

Control options

Steuerungsmöglichkeiten
Possibilités de commande



Set your smart home as you prefer! With the app, voice commands, or remote control.

Steuern Sie Ihr Smart Home wie Sie es möchten! Via App, Sprachsteuerung oder mit der Fernbedienung.

Commandez votre Smart Home comme vous le souhaitez ! Via l'appli, la commande vocale ou la télécommande.



APP CONTROL

Use the free app for smartphone or tablet.
Nutzen Sie die kostenlose App für das Smartphone oder Tablet.
Utilisez l'application gratuite pour smartphone ou tablette.



VOICE COMMANDS

Use intelligent voice assistants such as Google Home and Amazon Alexa.
Nutzen Sie intelligente Sprachassistenten wie Google Home und Amazon Alexa.
Utilisez des assistants vocaux intelligents comme Google Home ou Amazon Alexa.



REMOTE CONTROL

Use the practical remote connect.z operation at any time.
Nutzen Sie auch jederzeit die praktische connect.z Fernbedienung.
Vous pouvez aussi utiliser à tout moment la télécommande connect.z.



CONNECT.Z ACCESSORIES

Use clever accessories such as the movement sensor and much more.
Nutzen Sie cleveres Zubehör wie z.B. den Bewegungssensor uvm.
Utilisez des accessoires malins tels que le capteur de mouvement et bien d'autres encore.



DIMMER FUNCTION

Use the practical dimmer function via app, speech command or remote control.
Nutzen Sie die praktische Dimmfunktion via App, Sprachbefehl oder Fernbedienung.
Utilisez la fonction de gradation via l'appli, la commande vocale ou la télécommande.

One system, many possibilities!

Ein System – viele Möglichkeiten!
Un système, de nombreuses possibilités!

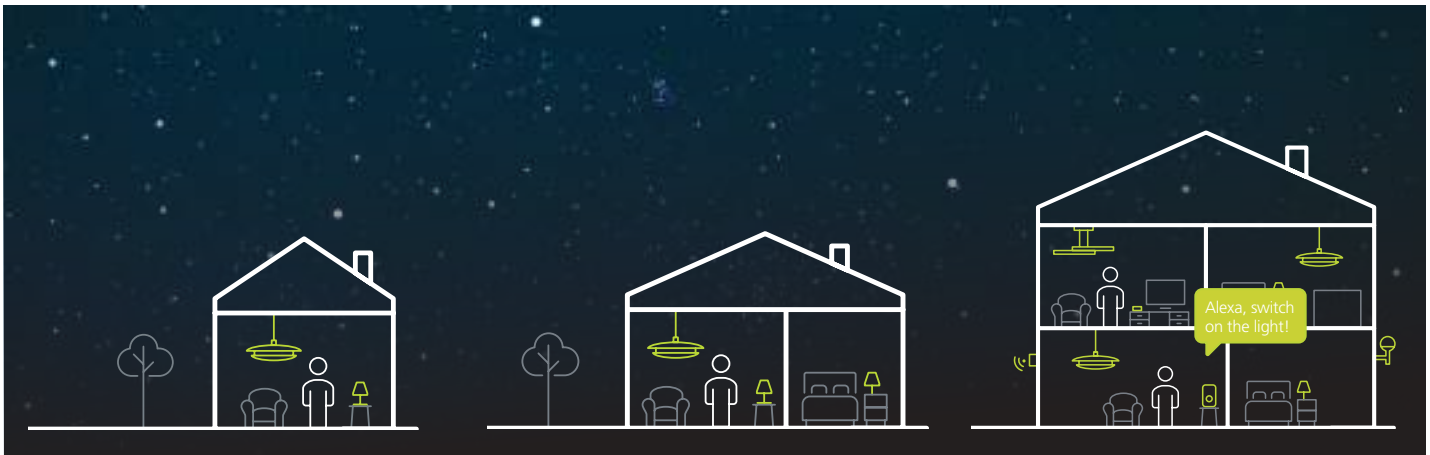

No matter how you start, you can integrate new products into your connect.z system at any time and gradually expand your smart home.
Egal wie Sie starten, Sie können jederzeit neue Produkte in Ihr connect.z System integrieren und Ihr smartes Zuhause nach und nach erweitern.
Quel que soit votre choix, vous pouvez à tout moment intégrer de nouveaux produits à votre système connect.z et améliorer progressivement votre maison intelligente.



All you need to start is a connect.z product and the remote control. No internet connection is required and you have access to:

Sie benötigen zum Start lediglich ein connect.z Produkt und die Fernbedienung. Es wird kein Internetzugang benötigt und Sie haben Zugriff auf:

Pour démarrer, il vous suffit d'un produit connect.z et de la télécommande. Aucune connexion Internet n'est nécessaire. Vous avez accès aux :

Standard functions:
Standardfunktionen:
Fonctionnalités standard :

- › Select colour/ Farbauswahl/ sélection de couleur
- › Change colour/ Farbwechsel/ changement decouleur
- › Dim/ Dimmen/ gradation
- › Favourites (2x)/ Favoriten (2x)/ favoris (2x)
- › Groups (3x)/ Gruppen (3x)/ groupes (3x)
- › Candle mode/ Kerzenmodus/ mode bougie



Besides the standard functions, would you also like access to the practical convenience features? Then you need only your smartphone or tablet and the Awox app. This app allows you to control your lights via Bluetooth®.

Sie möchten zu den Standardfunktionen auch noch Zugriff auf die praktischen Komfortfunktionen haben? Dann benötigen Sie nur Ihr Smartphone oder Tablet und die Awox App. Mit der App haben Sie die Möglichkeit, Ihre Leuchten über Bluetooth® zu steuern.

Outre les options standard, vous souhaitez également pouvoir utiliser les fonctionnalités de confort les plus pratiques ? Pour cela, vous avez seulement besoin de votre smartphone ou de votre tablette et de l'appli Awox. L'appli vous permet de commander vos luminaires via Bluetooth®.

Standard functions + convenience features/
Standardfunktionen + Komfortfunktionen /
Fonctionnalités standard + confort

- › Light alarm clock/ Lichtwecker/ réveil lumineux
- › Presence simulation/ Anwesenheitssimulation/ simulateur de présence
- › Disco function/ Discofunktion/ fonction disco
- › Timers & timetables /Timer & Zeitpläne/ minuteur et calendrier
- › Accessories can be incorporated/ Einbindung von Zubehör möglich/ connexion d'accessoires possible



Use the system's full potential and control your smart home through the Awox app using WIFI or Bluetooth® as well as integrating a voice assistant into the system. This gives you:

Nutzen Sie das volle Potenzial des Systems und steuern Sie Ihr Smart Home über die Awox App mithilfe von WLAN oder Bluetooth® und integrieren Sie zusätzlich noch einen Sprachassistenten in das System. So mit erhalten Sie:

Exploitez tout le potentiel du système en commandant votre Smart Home grâce à l'appli Awox via le réseau Wi-Fi ou Bluetooth®, et intégrez également un assistant vocal au système. Vous obtenez ainsi :

Standard functions + convenience features + voice commands*

Standardfunktionen + Komfortfunktionen + Sprachsteuerung*

Fonctionnalités standard + confort + commande vocale*

- › Amazon Alexa or Google Home/ Amazon Alexa oder Google Home/ Amazon Alexa ou Google Home

- * Use a voice assistant with integrated bridge.
- * Nutzen Sie einen Sprachassistenten mit integrierter Bridge.
- * Utilisez un assistant vocal avec Bridge intégré.

You already have connect-c luminaires from the previous system! What now?

Sie besitzen bereits connect-c Leuchten des Vorgängersystems! Was nun?
Vous disposez déjà de luminaires connect-c de l'ancien système! Que faire ?

No problem! The previous connect-c products are compatible with the new connect.z system.
Kein Problem! Die bisherigen connect-c Produkte sind mit dem neuen connect.z System kompatibel.
Aucun problème! Les anciens produits connect-c sont compatibles avec le nouveau système connect.z.

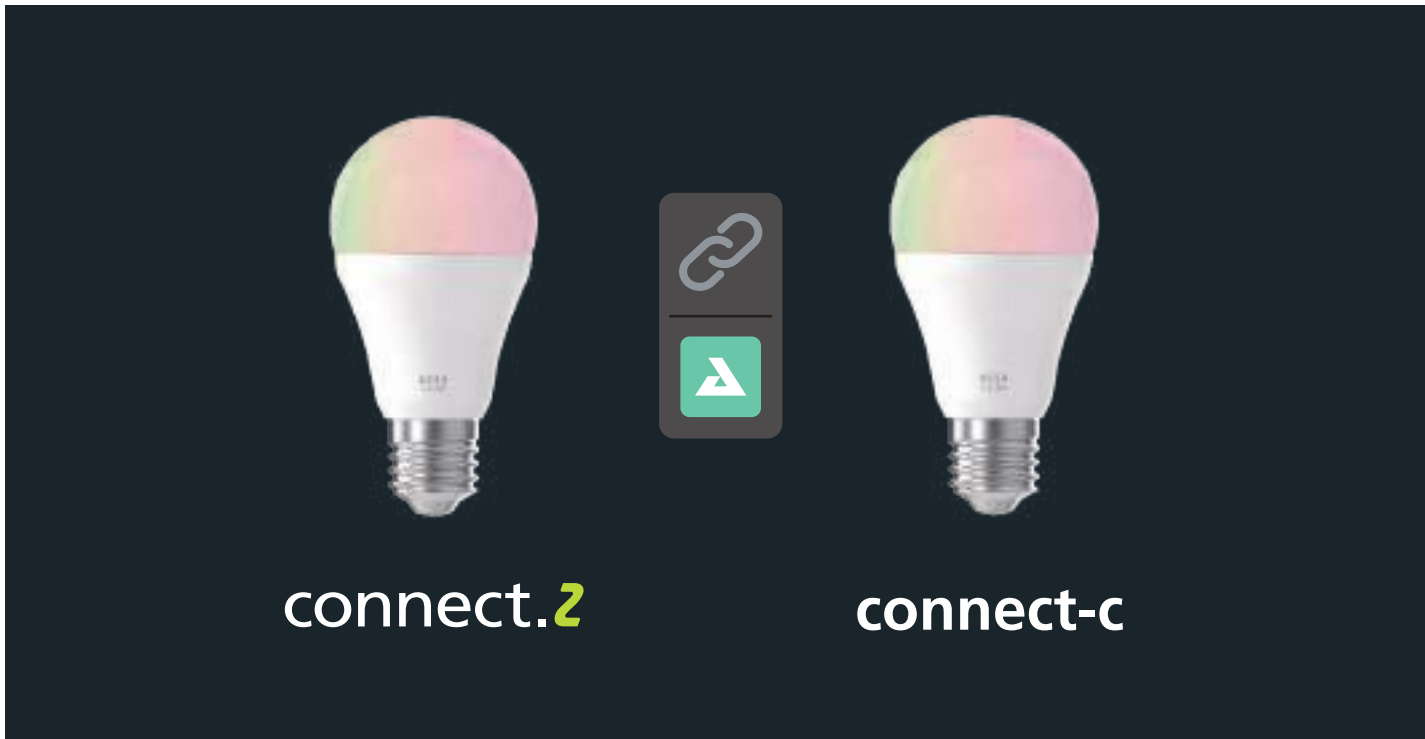

EGLO connect-c - connect.z

The existing EGLO connect-c system is compatible with the new EGLO connect.z system in the Awox Homecontrol App. You do not have to switch from the existing Bluetooth low energy system to the new open protocol ZigBee 3.0. EGLO connect-c luminaires can be integrated in the Awox app.

EGLO connect-c - connect.z

Das bestehende EGLO connect-c System ist mit dem neuen EGLO connect.z System in der Awox Homecontrol App kompatibel. Sie müssen nicht von dem bestehendem Bluetooth low energy System auf das neue offene Protokoll ZigBee 3.0 umsteigen. Leuchten von EGLO connect-c können in der Awox App eingebunden werden.

EGLO connect-c - connect.z

Le système EGLO connect-c existant est compatible avec le nouveau système EGLO connect.z dans l'application Awox Homecontrol. Vous n'avez pas besoin de passer du système Bluetooth low energy existant au nouveau protocole ouvert ZigBee 3.0. Les luminaires EGLO connect-c peuvent être intégrés dans l'application Awox.



99099

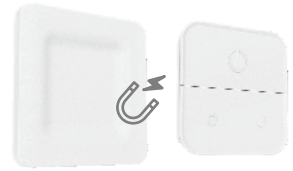

900116

The wall mount can be screwed or glued to smooth surfaces. The switch can be removed from its magnetic holder. With the three buttons, luminaires can be switched off, on and dimmed.

Die Wandhalterung kann geschraubt oder an glatte Oberflächen geklebt werden. Der Schalter kann aus seiner magnetischen Halterung herausgenommen werden. Mit den drei Tasten können Leuchten aus- und eingeschalten und gedimmt werden.

Le support mural peut être vissé ou collé sur une surface lisses. L'interrupteur peut être retiré de son support magnétique. Les trois boutons permettent d'éteindre, d'allumer et de faire varier l'intensité des luminaires.

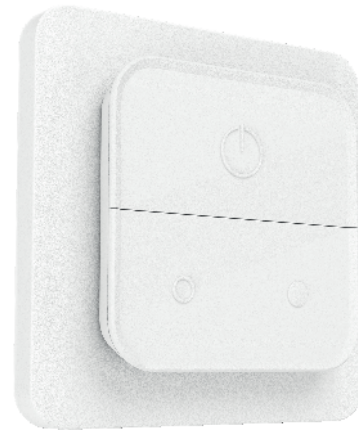

900116

99106



Mounting bracket incl.

Montagehalterung inkl.

Support de montage incl.

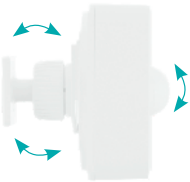

99106



120°, 12 m
20 sec. - 10 min.



IP44

99099 CONNECT Z

remote control; plastic, grey
Fernbedienung; Kunststoff, grau
Télécommande; plastique, gris

L 122, B 54, H 18



AAA,
R03P



1,5V



CR2032



9 002759 990992



B 54

L 122

99106 CONNECT-Z SENSOR

accessory; plastic, white
Zubehör; Kunststoff, weiss
Accessoires; plastique, blanc

L 75, H 75, A 70



120°, 12 m
20 sec. - 10 min.



AA,
LR6 HP



2900mAh,
1,5V



IP44



IP44



9 002759 991067

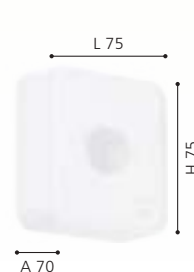

A 70

L 75

H 75

900116 CONNECT-Z SWITCH

remote control; plastic, white
Fernbedienung; Kunststoff, weiss
Télécommande; plastique, blanc

L 80, B 80, H 7



CR2032



9 008606 285761

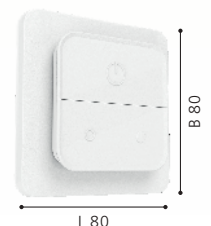

L 80

B 80



900878

LED



900879



ANDREAS-Z

These luminaires allow the full range of functions through 2 control units. RGB and TW can be adjusted up and down. Both directions can be dimmed independently and the color or whites can be turned on and off together or separately.

Diese Leuchten ermöglichen den vollen Funktionsumfang durch 2 Steuerungseinheiten. RGB und TW können nach oben und unten eingestellt werden. Beide Richtungen können unabhängig voneinander gedimmt werden und die Farbe oder Weißtöne können gemeinsam oder getrennt ein- und ausgeschaltet werden.

Ces luminaires permettent de bénéficier de toutes les fonctionnalités grâce à 2 unités de commande. RGB et TW peuvent être réglés vers le haut et vers le bas. Les deux directions peuvent être atténuées indépendamment l'une de l'autre et les couleurs ou les blancs peuvent être allumés et éteints ensemble ou séparément.



900878 ANDREAS-Z

pendant light; steel, black / plastic, white
Hängeleuchte; Stahl, schwarz / Kunststoff, weiss
luminaire en suspension; acier, noir / plastique, blanc

L 1170, B 70, H 1100

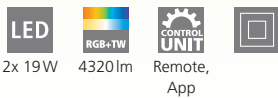

2x 19W 4320lm Remote, App

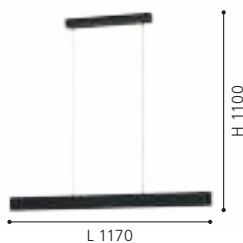

900879 ANDREAS-Z

pendant light; steel, grey / plastic, white
Hängeleuchte; Stahl, grau / Kunststoff, weiss
luminaire en suspension; acier, gris / plastique, blanc

L 1170, B 70, H 1100



2x 19W 4320lm Remote, App

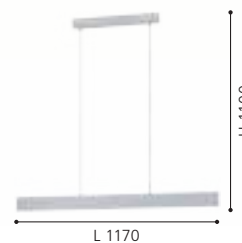



900387



900388



900387 ANCHORENA-Z

ceiling light; wood, steel, brown, black / plastic, white
Deckenleuchte; Holz, Stahl, braun, schwarz / Kunststoff, weiss
plafonnier; bois, acier, marron, noir / plastique, blanc

L 1230, B 80, H 110



35W



3980 lm



Remote,
App



9 008606 243662



900388 ANCHORENA-Z

pendant light; wood, steel, brown, black / plastic, white
Hängeleuchte; Holz, Stahl, braun, schwarz / Kunststoff, weiss
luminaire en suspension; bois, acier, marron, noir / plastique, blanc

L 1230, B 55, H 1100



35W



3980 lm



Remote,
App



9 008606 243679

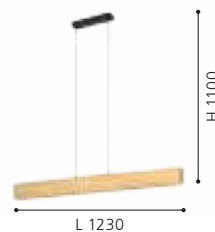

900391 ANCHORENA-Z

table light; wood, steel, brown, black / plastic, white
Tischleuchte; Holz, Stahl, braun, schwarz / Kunststoff, weiss
luminaire de table; bois, acier, marron, noir / plastique, blanc

L 75, B 55, H 465, Base: B 160, T 120



16W



1800 lm



Remote,
App



9 008606 243693

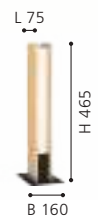



900391



900392 ANCHORENA-Z

floor light; wood, steel, brown, black / plastic, white
 Stehleuchte; Holz, Stahl, braun, schwarz / Kunststoff, weiss
 lampadaire; bois, acier, marron, noir / plastique, blanc

L 105, B 55, H 1500, Base: B 240, T 210



35W



3980lm



Remote,
App



L 105

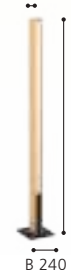

9 008606 243709



900392





900702

LED

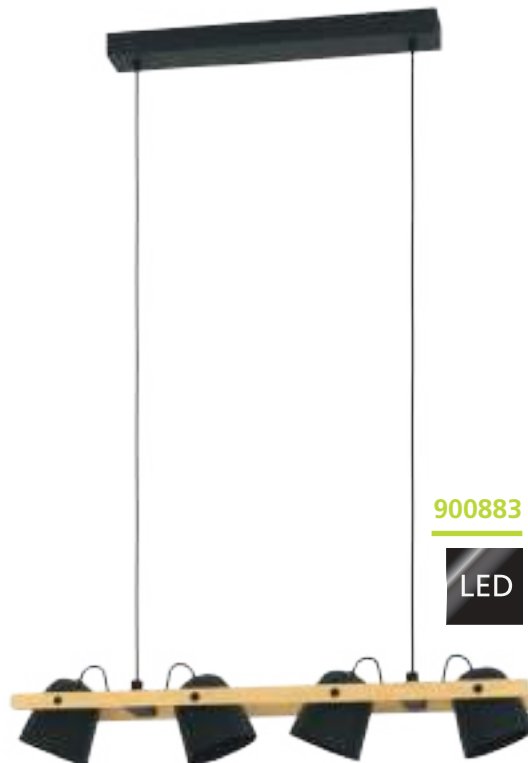

900883

LED



900882

LED



900702 KOKOMO-Z

pendant light; steel, wood, black, brown / aluminium, plastic, black, white

Hängeleuchte; Stahl, Holz, schwarz, braun / Alu, Kunststoff, schwarz, weiss

luminaire en suspension; acier, bois, noir, marron / aluminium, plastique, noir, blanc
L 990, B 50, H 1100

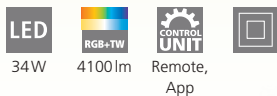

9 008606 262090

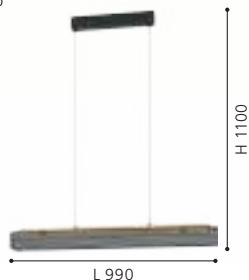

900883 HORNWOOD-Z

pendant light; steel, wood, black, brown
Hängeleuchte; Stahl, Holz, schwarz, braun
luminaire en suspension; acier, bois, noir, marron

L 780, B 140, H 1100

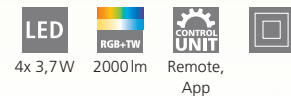

9 008606 274291



900882 HORNWOOD-Z

ceiling light; steel, wood, black, brown
Deckenleuchte; Stahl, Holz, schwarz, braun
plafonnier; acier, bois, noir, marron

L 780, B 140, H 160



9 008606 274284





900842

LED



900841

LED



900881

LED



900842 YUKU-Z

pendant light; steel, white / wood, fabric, brown, white
 Hängeleuchte; Stahl, weiss / Holz, Textil, braun, weiss
 luminaire en suspension; acier, blanc / bois, tissu, marron, blanc

H 1100, Ø 460



9 008606 274055



900841 YUKU-Z

ceiling light; steel, white / wood, fabric, brown, white
 Deckenleuchte; Stahl, weiss / Holz, Textil, braun, weiss
 plafonnier; acier, blanc / bois, tissu, marron, blanc

H 160, Ø 460



9 008606 274048

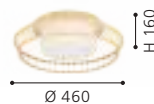

900881 PORTICO-Z

pendant light; steel, wood, white, brown / steel, glass, white, clear
 Hängeleuchte; Stahl, Holz, weiss, braun / Stahl, Glas, weiss, klar
 luminaire en suspension; acier, bois, blanc, marron / acier, verre, blanc, transparent

L 880, B 150, H 1100

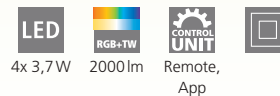

9 008606 274604

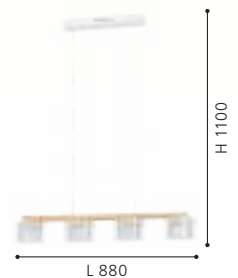



900853

LED



900855

LED

900853 BARBANO-Z

ceiling light; steel, black / fabric, plastic, black, white
 Deckenleuchte; Stahl, schwarz / Textil, Kunststoff, schwarz, weiss
 plafonnier; acier, noir / tissu, plastique, noir, blanc

L 605, B 565, H 90



3x 7,5W



2765lm



Remote,
App



900855 BARBANO-Z

ceiling light; steel, black / fabric, plastic, grey, white
 Deckenleuchte; Stahl, schwarz / Textil, Kunststoff, grau, weiss
 plafonnier; acier, noir / tissu, plastique, gris, blanc

L 605, B 565, H 90



3x 7,5W



2765lm



Remote,
App



9 008606 274185



9 008606 274208





900854 BARBANO-Z

pendant light; steel, black / fabric, plastic, black, white
 Hängeleuchte; Stahl, schwarz / Textil, Kunststoff, schwarz, weiss
 luminaire en suspension; acier, noir / tissu, plastique, noir, blanc

L 820, B 300, H 1100

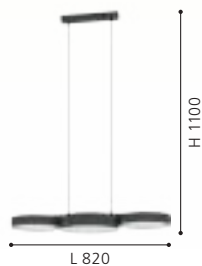
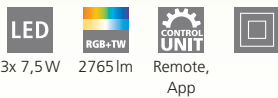

900856 BARBANO-Z

pendant light; steel, black / fabric, plastic, grey, white
 Hängeleuchte; Stahl, schwarz / Textil, Kunststoff, grau, weiss
 luminaire en suspension; acier, noir / tissu, plastique, gris, blanc

L 820, B 300, H 1100

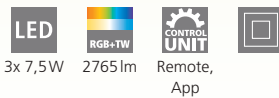



900439



900441



900442



900439 ROMAO-Z

ceiling light; steel, white / fabric, plastic, white
Deckenleuchte; Stahl, weiss / Textil, Kunststoff, weiss
plafonnier; acier, blanc / tissu, plastique, blanc

H 150, Ø 570

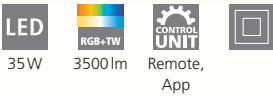

900441 ROMAO-Z

ceiling light; steel, white / fabric, plastic, taupe, white
Deckenleuchte; Stahl, weiss / Textil, Kunststoff, taupe, weiss
plafonnier; acier, blanc / tissu, plastique, taupe, blanc

H 150, Ø 570

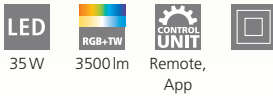

900442 ROMAO-Z

ceiling light; steel, white / fabric linen, plastic, grey, white
Deckenleuchte; Stahl, weiss / Textil Leinen, Kunststoff, grau, weiss
plafonnier; acier, blanc / tissu de lin, plastique, gris, blanc

H 150, Ø 570



9 008606 243914



9 008606 243921



9 008606 243938





900406



900407



900406 TOLLOS-Z

ceiling light; aluminium, steel, black, white / plastic, white
Deckenleuchte; Alu, Stahl, schwarz, weiss / Kunststoff, weiss
plafonnier; aluminium, acier, noir, blanc / plastique, blanc

H 130, Ø 400

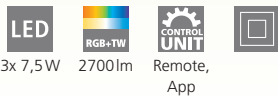

3x 7,5W 2700lm Remote, App



9 008606 243792



900407 TOLLOS-Z

ceiling light; aluminium, steel, black, white / plastic, white
Deckenleuchte; Alu, Stahl, schwarz, weiss / Kunststoff, weiss
plafonnier; aluminium, acier, noir, blanc / plastique, blanc

H 130, Ø 550

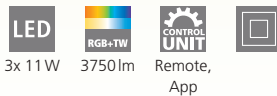

3x 11W 3750lm Remote, App



9 008606 243808





900723





900722

LED



DIMMABLE
VIA REMOTE
AND APP



900724

LED

900723 GINESTRONE-Z

pendant light; steel, black / plastic, white
Hängeleuchte; Stahl, schwarz / Kunststoff, weiss
luminaire en suspension; acier, noir / plastique, blanc

H 1100, Ø 450

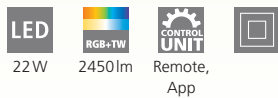

22W 2450lm Remote, App



9 008606 270507



900722 GINESTRONE-Z

ceiling light; steel, black / plastic, white
Deckenleuchte; Stahl, schwarz / Kunststoff, weiss
plafonnier; acier, noir / plastique, blanc

H 220, Ø 450



22W 2450lm Remote, App



9 008606 270491



900724 GINESTRONE-Z

pendant light; steel, black / plastic, white
Hängeleuchte; Stahl, schwarz / Kunststoff, weiss
luminaire en suspension; acier, noir / plastique, blanc

L 900, B 200, H 1100

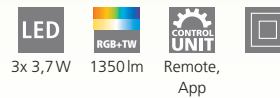

3x 3,7W 1350lm Remote, App



9 008606 274857

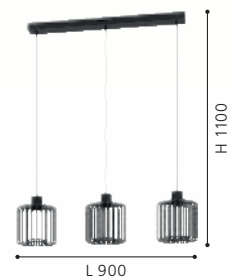



99679 SALVILANAS-Z

ceiling light; aluminium, steel, black / plastic, white
 Deckenleuchte; Alu, Stahl, schwarz / Kunststoff, weiss
 plafonnier; aluminium, acier, noir / plastique, blanc

L 770, B 200, H 75



21W 2700lm Remote, App



9 002759 996796



99678 SALVILANAS-Z

pendant light; aluminium, steel, black / plastic, white
 Hängeleuchte; Alu, Stahl, schwarz / Kunststoff, weiss
 luminaire en suspension; aluminium, acier, noir / plastique, blanc

L 770, B 200, H 1100

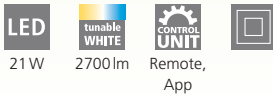

21W 2700lm Remote, App



9 002759 996789



99681 SALVILANAS-Z

pendant light; aluminium, steel, black / plastic, white
 Hängeleuchte; Alu, Stahl, schwarz / Kunststoff, weiss
 luminaire en suspension; aluminium, acier, noir / plastique, blanc

L 1160, B 200, H 1100



33W 4300lm Remote, App



9 002759 996819





99682



99683



99682 SALVILANAS-Z

table light; aluminium, steel, black / plastic, white
Tischleuchte; Alu, Stahl, schwarz / Kunststoff, weiss
luminaire de table; aluminium, acier, noir / plastique, blanc

L 160, B 35, H 425, Base: B 240, T 160



9 002759 996826



99683 SALVILANAS-Z

floor light; aluminium, steel, black / plastic, white
Stehleuchte; Alu, Stahl, schwarz / Kunststoff, weiss
lampadaire; aluminium, acier, noir / plastique, blanc

L 200, B 35, H 1305, Base: B 280, T 180



9 002759 996833

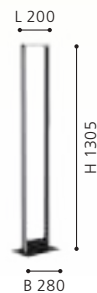

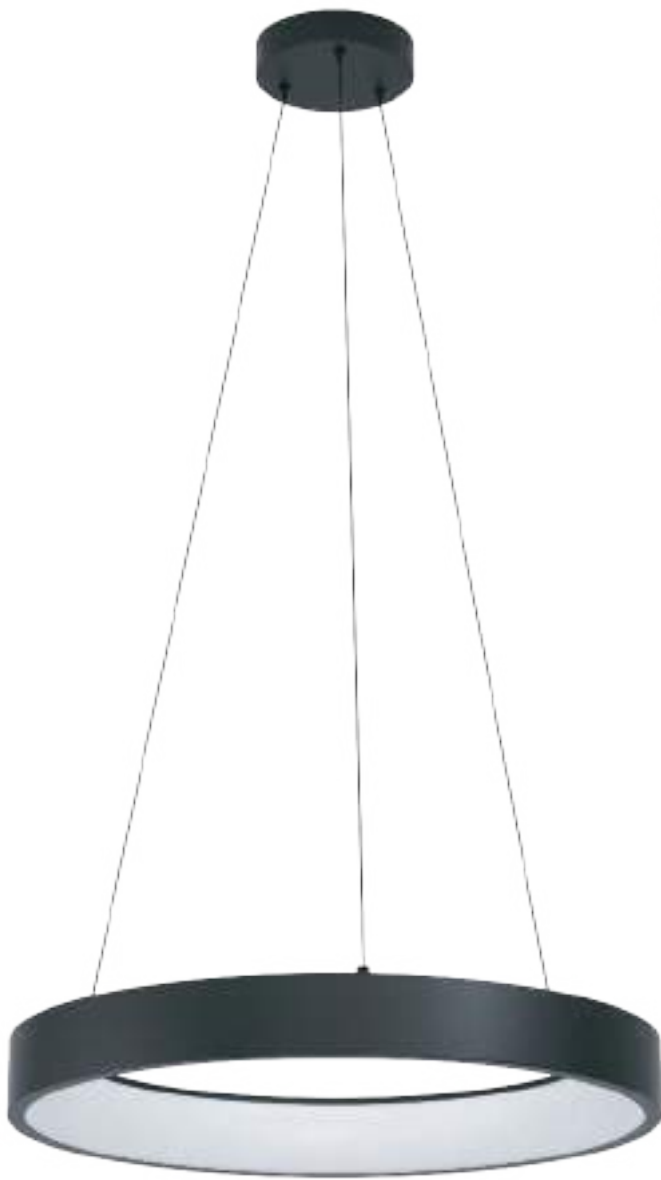

900068



900067



900069



900068 MARGHERA-Z

pendant light; steel, black / plastic, white
 Hängeleuchte; Stahl, schwarz / Kunststoff, weiss
 luminaire en suspension; acier, noir / plastique, blanc

H 1100, Ø 600



4x 6,5W 3120lm Remote, App



900067 MARGHERA-Z

ceiling light; steel, black / plastic, white
 Deckenleuchte; Stahl, schwarz / Kunststoff, weiss
 plafonnier; acier, noir / plastique, blanc

H 110, Ø 600



4x 6,5W 3120lm Remote, App



900069 MARGHERA-Z

wall light; steel, black / plastic, white
 Wandleuchte; Stahl, schwarz / Kunststoff, weiss
 Applique; acier, noir / plastique, blanc

L 270, H 305, A 200



4x 4W 1800lm Remote, App





900071



900072



900071 MARGHERA-Z

table light; steel, black / plastic, white
Tischleuchte; Stahl, schwarz / Kunststoff, weiss
luminaire de table; acier, noir / plastique, blanc

L 270, H 265, Base: Ø 145

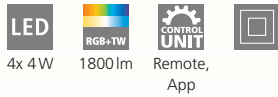

9 008606 222056



900072 MARGHERA-Z

floor light; steel, black / plastic, white
Stehleuchte; Stahl, schwarz / Kunststoff, weiss
lampadaire; acier, noir / plastique, blanc

L 270, B 305, H 1690, Base: Ø 305



9 008606 222063

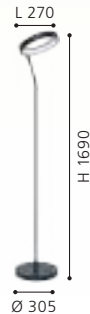



99603



99601



99602



99603 SIMOLARIS-Z

pendant light; aluminium, steel, black / plastic, white
 Hängeleuchte; Alu, Stahl, schwarz / Kunststoff, weiss
 luminaire en suspension; aluminium, acier, noir / plastique, blanc

L 1220, B 55, H 1100

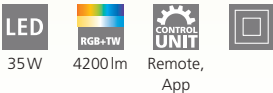

99601 SIMOLARIS-Z

ceiling light; aluminium, steel, black / plastic, white
 Deckenleuchte; Alu, Stahl, schwarz / Kunststoff, weiss
 plafonnier; aluminium, acier, noir / plastique, blanc

L 470, B 55, H 110



99602 SIMOLARIS-Z

ceiling light; aluminium, steel, black / plastic, white
 Deckenleuchte; Alu, Stahl, schwarz / Kunststoff, weiss
 plafonnier; aluminium, acier, noir / plastique, blanc

L 1220, B 55, H 110

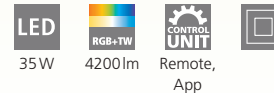



99604



99605



99604 SIMOLARIS-Z

table light; aluminium, steel, black / plastic, white
Tischleuchte; Alu, Stahl, schwarz / Kunststoff, weiss
luminaire de table; aluminium, acier, noir / plastique, blanc

L 55, B 55, H 515, Base: B 160, T 120



9 002759 996048



99605 SIMOLARIS-Z

floor light; aluminium, steel, black / plastic, white
Stehleuchte; Alu, Stahl, schwarz / Kunststoff, weiss
lampadaire; aluminium, acier, noir / plastique, blanc

L 55, B 55, H 1615, Base: B 240, T 210



9 002759 996055

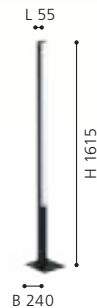



900079



900081



900082



900079 FRAIOLI-Z

ceiling light; aluminium, black / plastic, white
Deckenleuchte; Alu, schwarz / Kunststoff, weiss
plafonnier; aluminium, noir / plastique, blanc

L 1055, B 120, H 65



2x 17W 4800lm Remote, App



900081 FRAIOLI-Z

pendant light; aluminium, black / plastic, white
Hängeleuchte; Alu, schwarz / Kunststoff, weiss
luminaire en suspension; aluminium, noir / plastique, blanc

L 1055, B 100, H 1200



2x 17W 4800lm Remote, App



900082 FRAIOLI-Z

floor light; aluminium, black / plastic, white
Stehleuchte; Alu, schwarz / Kunststoff, weiss
lampadaire; aluminium, noir / plastique, blanc

H 1755, Base: B 280, T 280



2x 17W 4800lm Remote, App





900076



900077



900078



900076 FRAIOLI-Z

ceiling light; aluminium, satin nickel / plastic, white
Deckenleuchte; Alu, nickel-matt / Kunststoff, weiss
plafonnier; aluminium, nickel mat / plastique, blanc

L 1055, B 120, H 65



2x 17W 4800lm Remote, App



9 008606 223534



900077 FRAIOLI-Z

pendant light; aluminium, satin nickel / plastic, white
Hängeleuchte; Alu, nickel-matt / Kunststoff, weiss
luminaire en suspension; aluminium, nickel mat / plastique, blanc

L 1055, B 100, H 1200



2x 17W 4800lm Remote, App



9 008606 223541



900078 FRAIOLI-Z

floor light; aluminium, satin nickel / plastic, white
Stehleuchte; Alu, nickel-matt / Kunststoff, weiss
lampadaire; aluminium, nickel mat / plastique, blanc

H 1755, Base: B 280, T 280



2x 17W 4800lm Remote, App



9 008606 223558

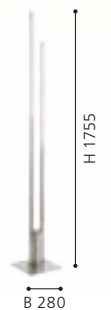



900479

LED



900478

LED

900479 LOBINERO-Z

pendant light; aluminium, steel, black / plastic, white
 Hängeleuchte; Alu, Stahl, schwarz / Kunststoff, weiss
 luminaire en suspension; aluminium, acier, noir / plastique, blanc

H 1100, Ø 580



43,2W 6000lm Remote, App



9 008606 244157

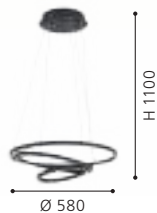

900478 LOBINERO-Z

pendant light; aluminium, steel, white / plastic, white
 Hängeleuchte; Alu, Stahl, weiss / Kunststoff, weiss
 luminaire en suspension; aluminium, acier, blanc / plastique, blanc

H 1100, Ø 580



43,2W 6000lm Remote, App



9 008606 244140

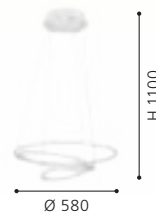

900398 ZILLERIO-Z

pendant light; steel, aluminium, black / plastic, white
 Hängeleuchte; Stahl, Alu, schwarz / Kunststoff, weiss
 luminaire en suspension; acier, aluminium, noir / plastique, blanc

L 1160, B 300, H 1100

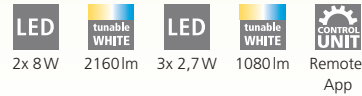

2x 8W 2160lm 3x 2,7W 1080lm Remote, App



9 008606 240593

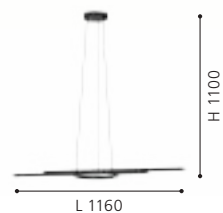



900398

LED

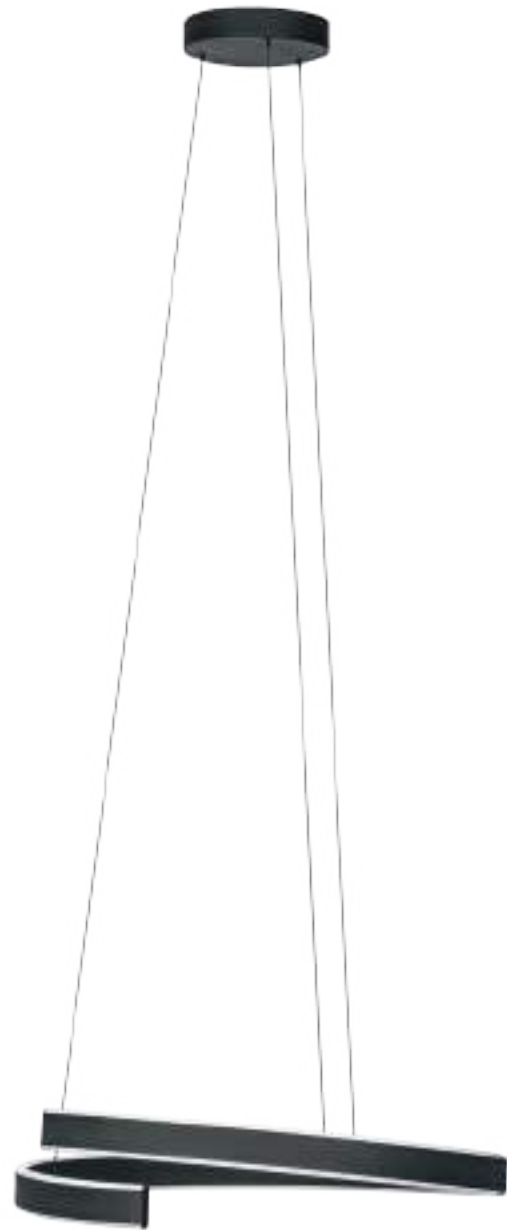

900404

LED

900404 ANDABAIA-Z

pendant light; aluminium, steel, black / plastic, white
 Hängeleuchte; Alu, Stahl, schwarz / Kunststoff, weiss
 luminaire en suspension; aluminium, acier, noir / plastique, blanc

H 1540, Ø 600

LED

42,5W

tunable
WHITE

5300lm

CONTROL
UNIT

Remote,
App

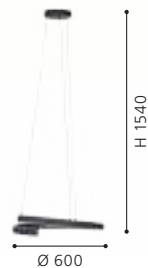



900019



IP44



900021



IP44

900019 TABIANO-Z

mirror light; steel, chrome / plastic, white
 Spiegelleuchte; Stahl, chrom / Kunststoff, weiss
 applique pour miroir; acier, chrome / plastique, blanc

L 605, H 70, A 135



15,6W



1950lm



Remote,
App



IP44



900021 TABIANO-Z

mirror light; steel, chrome / plastic, white
 Spiegelleuchte; Stahl, chrom / Kunststoff, weiss
 applique pour miroir; acier, chrome / plastique, blanc

L 905, H 70, A 135



21,5W



2750lm



Remote,
App



IP44



9 008606 221646



9 008606 221653





99676

LED



99677

LED



99676 LOMALTAS-Z

ceiling light; steel, wood, black, brown / plastic, white
Deckenleuchte; Stahl, Holz, schwarz, braun / Kunststoff, weiss
plafonnier; acier, bois, noir, marron / plastique, blanc

L 580, B 350



99677 LOMALTAS-Z

ceiling light; steel, wood, black, brown / plastic, white
Deckenleuchte; Stahl, Holz, schwarz, braun / Kunststoff, weiss
plafonnier; acier, bois, noir, marron / plastique, blanc

L 770, B 495, H 85

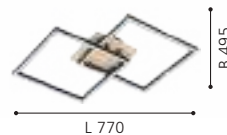



900315



900317



900316



900315 PARANDAY-Z

ceiling light; steel, black / plastic, white
Deckenleuchte; Stahl, schwarz / Kunststoff, weiss
plafonnier; acier, noir / plastique, blanc

L 470, B 225, H 60



15,5W 1800lm Remote, App

900316 PARANDAY-Z

ceiling light; steel, black / plastic, white
Deckenleuchte; Stahl, schwarz / Kunststoff, weiss
plafonnier; acier, noir / plastique, blanc

L 525, B 310, H 60



21,5W 2500lm Remote, App

900317 PARANDAY-Z

ceiling light; steel, black / plastic, white
Deckenleuchte; Stahl, schwarz / Kunststoff, weiss
plafonnier; acier, noir / plastique, blanc

L 650, B 310, H 60

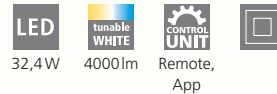

32,4W 4000lm Remote, App



9 008606 231195

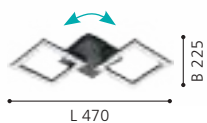

9 008606 231201



9 008606 231218

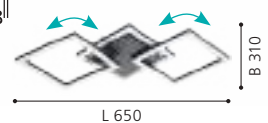



900318 PARANDAY-Z

ceiling light; steel, black / plastic, white
Deckenleuchte; Stahl, schwarz / Kunststoff, weiss
plafonnier; acier, noir / plastique, blanc

L 470, B 430, H 65



42 W



5000 lm



Remote,
App



9 008606 231225



900318





900322



900323



900324



900322 PARRAPOS-Z

ceiling light; steel, black / plastic, white
Deckenleuchte; Stahl, schwarz / Kunststoff, weiss
plafonnier; acier, noir / plastique, blanc

L 445, B 300, H 70



15W 2100lm Remote, App

900323 PARRAPOS-Z

ceiling light; steel, black / plastic, white
Deckenleuchte; Stahl, schwarz / Kunststoff, weiss
plafonnier; acier, noir / plastique, blanc

L 340, B 300, H 45

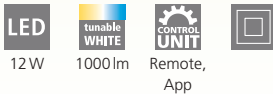

12W 1000lm Remote, App

900324 PARRAPOS-Z

wall light; steel, black / plastic, white
Wandleuchte; Stahl, schwarz / Kunststoff, weiss
Applique; acier, noir / plastique, blanc

L 200, H 240, A 50



12W 850lm Remote, App



9 008606 231256



9 008606 231263



9 008606 231270





900319

LED



900321

LED



900319 PARRAPOS-Z

ceiling light; steel, black / plastic, white
 Deckenleuchte; Stahl, schwarz / Kunststoff, weiss
 plafonnier; acier, noir / plastique, blanc

L 615, B 450, H 80



900321 PARRAPOS-Z

ceiling light; steel, black / plastic, white
 Deckenleuchte; Stahl, schwarz / Kunststoff, weiss
 plafonnier; acier, noir / plastique, blanc

L 545, B 445, H 90

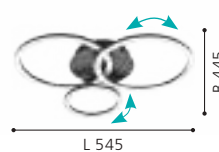
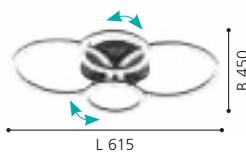

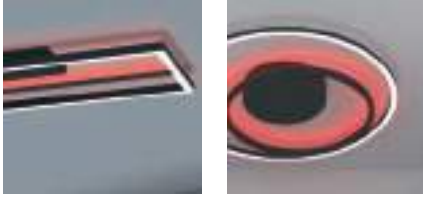

CALAGRANO-Z

These lights have individually controllable light settings on the inside and outside of the frame.

Diese Leuchten verfügen über individuell steuerbare Lichteinstellungen der Rahmen innen und außen.

Ces lumières ont des paramètres d'éclairage contrôlables individuellement du cadre.



900729



900728



900567



900728 CALAGRANO-Z

ceiling light; aluminium, steel, black / plastic, white
Deckenleuchte; Alu, Stahl, schwarz / Kunststoff, weiss
plafonnier; aluminium, acier, noir / plastique, blanc

H 35, Ø 450



21,5W



2700lm



Remote,
App



9 008606 262229



900729 CALAGRANO-Z

ceiling light; aluminium, steel, black / plastic, white
Deckenleuchte; Alu, Stahl, schwarz / Kunststoff, weiss
plafonnier; aluminium, acier, noir / plastique, blanc

L 450, B 450, H 50



21W



2900lm



Remote,
App



9 008606 262236

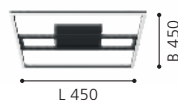

900567 CALAGRANO-Z

ceiling light; aluminium, steel, black / plastic, white
Deckenleuchte; Alu, Stahl, schwarz / Kunststoff, weiss
plafonnier; aluminium, acier, noir / plastique, blanc

L 640, B 220, H 50



21W



2600lm



Remote,
App



9 008606 244690

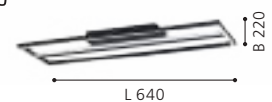



900566 CALAGRANO-Z

ceiling light; aluminium, steel, black / plastic, white
Deckenleuchte; Alu, Stahl, schwarz / Kunststoff, weiss
plafonnier; aluminium, acier, noir / plastique, blanc

L 640, B 240, H 45



21 W



2600 lm



Remote,
App



9 008606 244683



900566

LED



900408



900409



900408 MONTEMORELOS-Z

ceiling light; aluminium, white / plastic with crystal effect, white
Deckenleuchte; Alu, weiss / Kunststoff m. Kristalleffekt, weiss
plafonnier; aluminium, blanc / plastique avec effet cristal, blanc

H 50, Ø 420

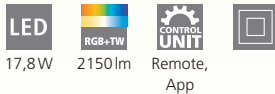

17,8W 2150lm Remote, App



9 008606 243815



900409 MONTEMORELOS-Z

ceiling light; aluminium, white / plastic with crystal effect, white
Deckenleuchte; Alu, weiss / Kunststoff m. Kristalleffekt, weiss
plafonnier; aluminium, blanc / plastique avec effet cristal, blanc

H 70, Ø 570



34,5W 4100lm Remote, App



9 008606 243822





900411



900412

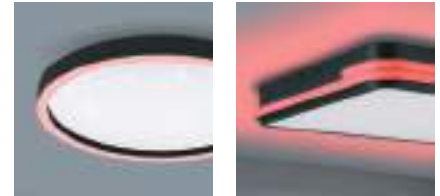

MONTEMORELOS-Z, GENOVESE-Z

The frame of these luminaires can switch between the RGB colors, the inner part can reproduce different white tones between 2700K and 6500K. By controlling via app or remote control, individual lighting effects can be set.

Der Rahmen dieser Leuchten kann zwischen den RGB Farbtönen wechseln, der Innenteil kann verschiedene Weißtöne zwischen 2700K und 6500K wiedergeben. Durch Steuerung per App oder Fernbedienung können so individuelle Lichtspiele eingestellt werden.

Le cadre de cette luminaires peut basculer entre les couleurs RVB, la partie intérieure peut reproduire différents tons blancs entre 2700K et 6500K. En contrôlant via l'application ou la télécommande, des effets d'éclairage individuels peuvent être définis.



900477



900411 MONTEMORELOS-Z

ceiling light; aluminium, black / plastic with crystal effect, white
Deckenleuchte; Alu, schwarz / Kunststoff m. Kristalleffekt, weiss
plafonnier; aluminium, noir / plastique avec effet cristal, blanc

H 50, Ø 420

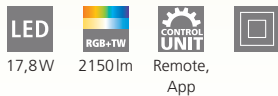

17,8W 2150lm Remote, App

900412 MONTEMORELOS-Z

ceiling light; aluminium, black / plastic with crystal effect, white
Deckenleuchte; Alu, schwarz / Kunststoff m. Kristalleffekt, weiss
plafonnier; aluminium, noir / plastique avec effet cristal, blanc

H 70, Ø 570



34,5W 4100lm Remote, App

900477 GENOVESE-Z

ceiling light; aluminium, steel, black / plastic, white
Deckenleuchte; Alu, Stahl, schwarz / Kunststoff, weiss
plafonnier; aluminium, acier, noir / plastique, blanc

L 470, B 470, H 70



22W 3000lm Remote, App



9 008606 243839



9 008606 243846



9 008606 252763





900088

LED



900086

LED



900089

LED



ROVITO-Z

These lights have individually controllable light settings on the inside and outside of the frame.

Diese Leuchten verfügen über individuell steuerbare Lichtstellungen der Rahmen innen und außen.

Ces lumières ont des paramètres d'éclairage contrôlables individuellement du cadre.

900088 ROVITO-Z

ceiling light; plastic, white / plastic, white
Deckenleuchte; Kunststoff, weiss / Kunststoff, weiss
plafonnier; plastique, blanc / plastique, blanc

L 295, B 295, H 25

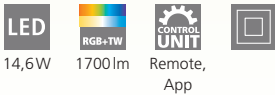

14,6W 1700lm Remote, App



900089 ROVITO-Z

ceiling light; plastic, white / plastic, white
Deckenleuchte; Kunststoff, weiss / Kunststoff, weiss
plafonnier; plastique, blanc / plastique, blanc

L 420, B 420, H 25

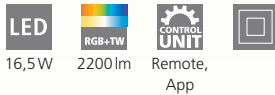

16,5W 2200lm Remote, App

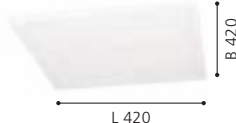

900086 ROVITO-Z

ceiling light; plastic, white / plastic, white
Deckenleuchte; Kunststoff, weiss / Kunststoff, weiss
plafonnier; plastique, blanc / plastique, blanc

H 25, Ø 295

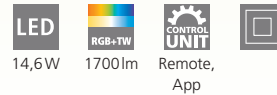

14,6W 1700lm Remote, App





900087



900087 ROVITO-Z

ceiling light; plastic, white / plastic, white

Deckenleuchte; Kunststoff, weiss / Kunststoff, weiss

plafonnier; plastique, blanc / plastique, blanc

H 25, Ø 420



16,5W



2200lm



Remote,
App



9 008606 225484





900093



900092



900094



900093 ROVITO-Z

ceiling light; plastic, black / plastic, white
Deckenleuchte; Kunststoff, schwarz / Kunststoff, weiss
plafonnier; plastique, noir / plastique, blanc

L 295, B 295, H 25



14,6W



1700lm



Remote,
App



900094 ROVITO-Z

ceiling light; plastic, black / plastic, white
Deckenleuchte; Kunststoff, schwarz / Kunststoff, weiss
plafonnier; plastique, noir / plastique, blanc

L 420, B 420, H 25



16,5W



2200lm



Remote,
App



900092 ROVITO-Z

ceiling light; plastic, black / plastic, white
Deckenleuchte; Kunststoff, schwarz / Kunststoff, weiss
plafonnier; plastique, noir / plastique, blanc

H 25, Ø 420



16,5W



2200lm



Remote,
App



9 008606 225538



9 008606 225545



9 008606 225521





ROVITO-Z

These lights have individually controllable light settings on the inside and outside of the frame.

Diese Leuchten verfügen über individuell steuerbare Lichteinstellungen der Rahmen innen und außen.

Ces lumières ont des paramètres d'éclairage contrôlables individuellement du cadre.

900091 ROVITO-Z

ceiling light; plastic, black / plastic, white
Deckenleuchte; Kunststoff, schwarz / Kunststoff, weiss
plafonnier; plastique, noir / plastique, blanc

H 25, Ø 295



14,6W



1700lm



Remote,
App



9 008606 225514

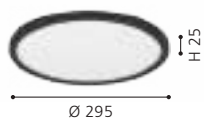

900091

LED



900481



900484



900483



900481 PADROGIANO-Z

ceiling light; steel, white / plastic, white
Deckenleuchte; Stahl, weiss / Kunststoff, weiss
plafonnier; acier, blanc / plastique, blanc

L 450, B 450, H 50

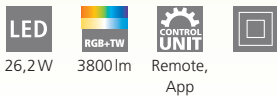

26,2W 3800lm Remote, App



9 008606 244164



900483 PADROGIANO-Z

ceiling light; steel, white / plastic, white
Deckenleuchte; Stahl, weiss / Kunststoff, weiss
plafonnier; acier, blanc / plastique, blanc

L 450, B 450, H 50

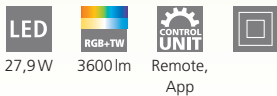

27,9W 3600lm Remote, App



9 008606 244188



900484 PADROGIANO-Z

ceiling light; steel, white / plastic, white
Deckenleuchte; Stahl, weiss / Kunststoff, weiss
plafonnier; acier, blanc / plastique, blanc

L 595, B 595, H 50



35,5W 4800lm Remote, App



9 008606 244195





900486

LED



PADROGIANO-Z

These lights have individually controllable light settings on the inside and outside of the frame.

Diese Leuchten verfügen über individuell steuerbare Lichteinstellungen der Rahmen innen und außen.

Ces lumières ont des paramètres d'éclairage contrôlables individuellement du cadre.



900487

LED



900486 PADROGIANO-Z

ceiling light; steel, white / plastic, white
Deckenleuchte; Stahl, weiss / Kunststoff, weiss
plafonnier; acier, blanc / plastique, blanc

H 50, Ø 450



26,5W

3300lm

Remote,
App

900487 PADROGIANO-Z

ceiling light; steel, white / plastic, white
Deckenleuchte; Stahl, weiss / Kunststoff, weiss
plafonnier; acier, blanc / plastique, blanc

H 50, Ø 595



35W

4600lm

Remote,
App



9 008606 244218



9 008606 244225





900482

LED



PADROGIANO-Z

The frame of these luminaires can switch between the RGB colors, the inner part can reproduce different white tones between 2700K and 6500K. By controlling via app or remote control, individual lighting effects can be set.

Der Rahmen dieser Leuchten kann zwischen den RGB Farbtönen wechseln, der Innenteil kann verschiedene Weißtöne zwischen 2700K und 6500K wiedergeben. Durch Steuerung per App oder Fernbedienung können so individuelle Lichtspiele eingestellt werden.

Le cadre de cette luminaires peut basculer entre les couleurs RVB, la partie intérieure peut reproduire différents tons blancs entre 2700K et 6500K. En contrôlant via l'application ou la télécommande, des effets d'éclairage individuels peuvent être définis.



900482 PADROGIANO-Z

ceiling light; steel, white / plastic, white
Deckenleuchte; Stahl, weiss / Kunststoff, weiss
plafonnier; acier, blanc / plastique, blanc

L 1200, B 300, H 50

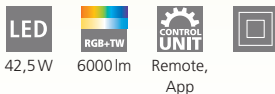

42,5 W 6000 lm Remote, App



9 008606 244171

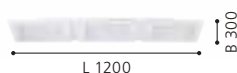

900485 PADROGIANO-Z

ceiling light; steel, white / plastic, white
Deckenleuchte; Stahl, weiss / Kunststoff, weiss
plafonnier; acier, blanc / plastique, blanc

L 1200, B 300, H 50



43,2 W 6000 lm Remote, App



9 008606 244201

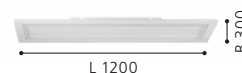

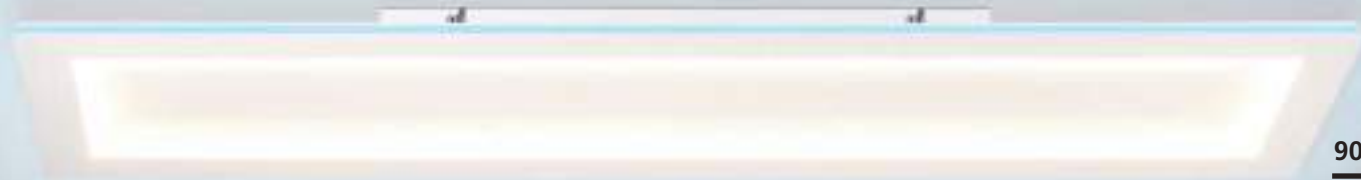

900485

LED





900025



SAVATARILA-Z

One frame of the luminaires is rotatable.
 Ein Rahmen der Leuchten ist drehbar.
 Un cadre de les luminaires est rotatif.

900025 SAVATARILA-Z

ceiling light; steel, black / plastic, white
 Deckenleuchte; Stahl, schwarz / Kunststoff, weiss
 plafonnier; acier, noir / plastique, blanc

L 450, B 450, H 70



4x 2,7W



1320lm



4x 2,7W



1280lm



Remote,
App

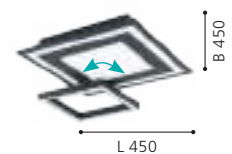



900022



900024



900023



900023 SAVATARILA-Z

ceiling light; steel, white / plastic, white
Deckenleuchte; Stahl, weiss / Kunststoff, weiss
plafonnier; acier, blanc / plastique, blanc

L 450, B 450, H 70



4x 2,7W

660lm

4x 2,7W

640lm

Remote, App



9 008606 221677

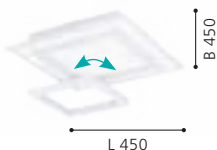

L 450

900022 SALITERAS-Z

ceiling light; steel, white / plastic, white
Deckenleuchte; Stahl, weiss / Kunststoff, weiss
plafonnier; acier, blanc / plastique, blanc

L 1160, B 160, H 50



2x 10,2W

3100lm

Remote, App



9 008606 221660

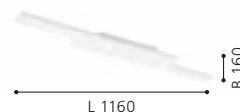

L 1160

900024 SALITERAS-Z

ceiling light; steel, black / plastic, white
Deckenleuchte; Stahl, schwarz / Kunststoff, weiss
plafonnier; acier, noir / plastique, blanc

L 1160, B 160, H 50



2x 10,2W

3100lm

Remote, App



9 008606 221684



L 1160



900054



900056



TURCONA-Z

Frameless luminaires
Rahmenlose Leuchten
Luminaire sans cadre



900054 TURCONA-Z

ceiling light; steel, aluminium, white / plastic, white
Deckenleuchte; Stahl, Alu, weiss / Kunststoff, weiss
plafonnier; acier, aluminium, blanc / plastique, blanc

H 60, Ø 300

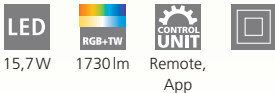

15,7W 1730lm Remote, App



9 008606 221905



900056 TURCONA-Z

ceiling light; steel, aluminium, white / plastic, white
Deckenleuchte; Stahl, Alu, weiss / Kunststoff, weiss
plafonnier; acier, aluminium, blanc / plastique, blanc

H 75, Ø 600

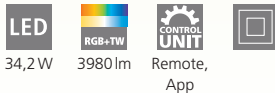

34,2W 3980lm Remote, App



9 008606 221929



900055 TURCONA-Z

ceiling light; steel, aluminium, white / plastic, white
Deckenleuchte; Stahl, Alu, weiss / Kunststoff, weiss
plafonnier; acier, aluminium, blanc / plastique, blanc

H 75, Ø 450

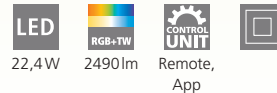

22,4W 2490lm Remote, App



9 008606 221912





900055

LED

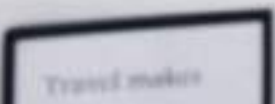



900057



900058



900059



TURCONA-Z

Frameless luminaires

Rahmenlose Leuchten

Luminaires sans cadre

900057 TURCONA-Z

ceiling light; steel, aluminium, white / plastic, white
Deckenleuchte; Stahl, Alu, weiss / Kunststoff, weiss
plafonnier; acier, aluminium, blanc / plastique, blanc

L 300, B 300, H 50



16W



1750lm



Remote,
App



900058 TURCONA-Z

ceiling light; steel, aluminium, white / plastic, white
Deckenleuchte; Stahl, Alu, weiss / Kunststoff, weiss
plafonnier; acier, aluminium, blanc / plastique, blanc

L 450, B 450, H 70



6x 3,8W



2400lm



Remote,
App



900059 TURCONA-Z

ceiling light; steel, aluminium, white / plastic, white
Deckenleuchte; Stahl, Alu, weiss / Kunststoff, weiss
plafonnier; acier, aluminium, blanc / plastique, blanc

L 600, B 600, H 75



6x 5,4W



4000lm



Remote,
App



9 008606 221936

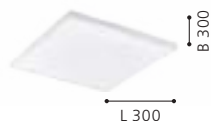

9 008606 221943

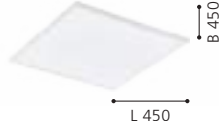

9 008606 221950





900062



900061



900062 TURCONA-Z

ceiling light; steel, aluminium, white / plastic, white
 Deckenleuchte; Stahl, Alu, weiss / Kunststoff, weiss
 plafonnier; acier, aluminium, blanc / plastique, blanc

L 1200, B 100, H 75

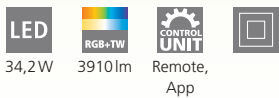

34,2W 3910lm Remote, App

900061 TURCONA-Z

ceiling light; steel, aluminium, white / plastic, white
 Deckenleuchte; Stahl, Alu, weiss / Kunststoff, weiss
 plafonnier; acier, aluminium, blanc / plastique, blanc

L 1200, B 300, H 75



3x 10,6W 4000lm Remote, App



9 008606 221974

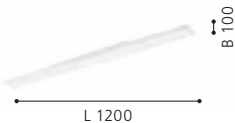

9 008606 221967

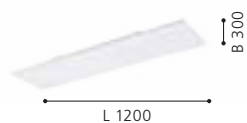



900762

LED

DESIGN
HIGHLIGHT
DETAIL



900762 SARSINA-Z

ceiling light; aluminium, steel, black / plastic, white
Deckenleuchte; Alu, Stahl, schwarz / Kunststoff, weiss
plafonnier; aluminium, acier, noir / plastique, blanc

H 52, Ø 600

LED
41 W

tunable
WHITE
5800lm

CONTROL
UNIT
Remote,
App

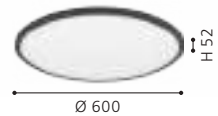



900759



900761



900758



900761 SARSINA-Z

ceiling light; aluminium, steel, black / plastic, white
Deckenleuchte; Alu, Stahl, schwarz / Kunststoff, weiss
plafonnier; aluminium, acier, noir / plastique, blanc

H 52, Ø 450



9 008606 264063



900759 SARSINA-Z

ceiling light; aluminium, steel, white / plastic, white
Deckenleuchte; Alu, Stahl, weiss / Kunststoff, weiss
plafonnier; aluminium, acier, blanc / plastique, blanc

H 52, Ø 600



9 008606 264056



900758 SARSINA-Z

ceiling light; aluminium, steel, white / plastic, white
Deckenleuchte; Alu, Stahl, weiss / Kunststoff, weiss
plafonnier; aluminium, acier, blanc / plastique, blanc

H 52, Ø 450



9 008606 264049





900044



900045



900046



900044 SALOBRENA-Z

ceiling light; aluminium, white / plastic, white
Deckenleuchte; Alu, weiss / Kunststoff, weiss
plafonnier; aluminium, blanc / plastique, blanc

L 300, B 300, H 50

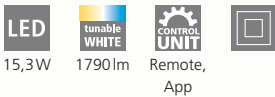

15,3W 1790lm Remote, App



9 008606 221813

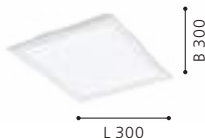

900045 SALOBRENA-Z

ceiling light; aluminium, white / plastic, white
Deckenleuchte; Alu, weiss / Kunststoff, weiss
plafonnier; aluminium, blanc / plastique, blanc

L 450, B 450, H 50



21,5W 2500lm Remote, App



9 008606 221820

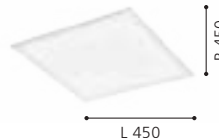

900046 SALOBRENA-Z

ceiling light; aluminium, white / plastic, white
Deckenleuchte; Alu, weiss / Kunststoff, weiss
plafonnier; aluminium, blanc / plastique, blanc

L 595, B 595, H 50

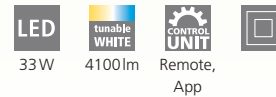

33W 4100lm Remote, App



9 008606 221837





900047

LED



900048

LED



900047 SALOBRENA-Z

ceiling light; aluminium, white / plastic, white
Deckenleuchte; Alu, weiss / Kunststoff, weiss
plafonnier; aluminium, blanc / plastique, blanc

L 1200, B 300, H 50



33,5W 4150lm Remote, App



9 008606 221844



900048 SALOBRENA-Z

ceiling light; aluminium, white / plastic, white
Deckenleuchte; Alu, weiss / Kunststoff, weiss
plafonnier; aluminium, blanc / plastique, blanc

L 1200, B 100, H 45

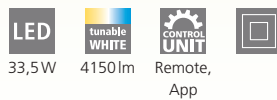

33,5W 4150lm Remote, App



9 008606 221851

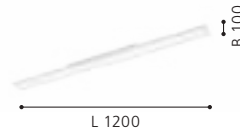

Zubehör inkludiert
Accessoires inclus



900049



900051



900052



900049 SALOBRENA-Z

ceiling light; aluminium, black / plastic, white
Deckenleuchte; Alu, schwarz / Kunststoff, weiss
plafonnier; aluminium, noir / plastique, blanc

L 300, B 300, H 50

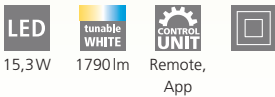

15,3W 1790lm Remote, App



9 008606 221868

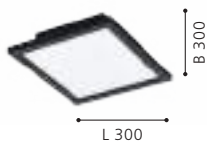

900051 SALOBRENA-Z

ceiling light; aluminium, black / plastic, white
Deckenleuchte; Alu, schwarz / Kunststoff, weiss
plafonnier; aluminium, noir / plastique, blanc

L 450, B 450, H 50



21,5W 2500lm Remote, App



9 008606 221875

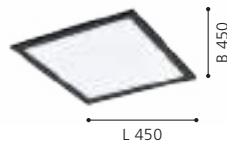

900052 SALOBRENA-Z

ceiling light; aluminium, black / plastic, white
Deckenleuchte; Alu, schwarz / Kunststoff, weiss
plafonnier; aluminium, noir / plastique, blanc

L 595, B 595, H 50

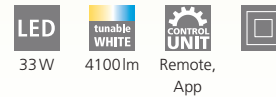

33W 4100lm Remote, App



9 008606 221882

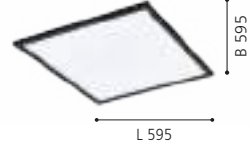



900053

LED



900095

LED



900053 SALOBRENA-Z

ceiling light; aluminium, black / plastic, white
 Deckenleuchte; Alu, schwarz / Kunststoff, weiss
 plafonnier; aluminium, noir / plastique, blanc

L 1200, B 300, H 50

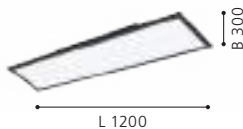

900095 SALOBRENA-Z

ceiling light; aluminium, steel, black / plastic, white
 Deckenleuchte; Alu, Stahl, schwarz / Kunststoff, weiss
 plafonnier; aluminium, acier, noir / plastique, blanc

L 1200, B 100, H 45

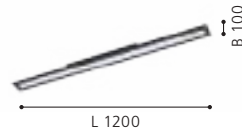
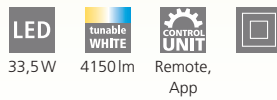

Zubehör inkludiert
 Accessoires inclus



99548



99549



99548 HERRORA-Z

ceiling light; aluminium, white / plastic, white
Deckenleuchte; Alu, weiss / Kunststoff, weiss
plafonnier; aluminium, blanc / plastique, blanc

L 595, B 595, H 40

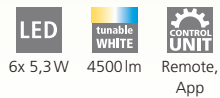

6x 5,3W 4500lm Remote, App



9 002759 995485



99549 HERRORA-Z

ceiling light; aluminium, white / plastic, white
Deckenleuchte; Alu, weiss / Kunststoff, weiss
plafonnier; aluminium, blanc / plastique, blanc

L 1200, B 300, H 40



3x 10,5W 4500lm Remote, App



9 002759 995492

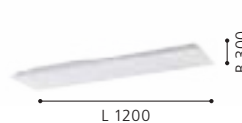

99639 HERRORA-Z

ceiling light; aluminium, white / plastic, white
Deckenleuchte; Alu, weiss / Kunststoff, weiss
plafonnier; aluminium, blanc / plastique, blanc

L 450, B 450, H 40



22W 2900lm Remote, App



9 002759 996390

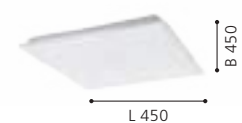



99639

LED





900101

LED



IP20/44

900099

LED



IP20/44



900102

LED



IP20/44



900099 FUEVA-Z

recessed light; steel, white / plastic, white
Einbauleuchte; Stahl, weiss / Kunststoff, weiss
luminaire encastrable; acier, blanc / plastique, blanc

H 26, Ø 85



3x 2,8W 3x 390lm Remote, App Ø75 IP20/44



Ø 85

900101 FUEVA-Z

recessed light; steel, white / plastic, white
Einbauleuchte; Stahl, weiss / Kunststoff, weiss
luminaire encastrable; acier, blanc / plastique, blanc

H 26, Ø 120



5,4W 800lm Remote, App Ø105 IP20/44



Ø 120

900102 FUEVA-Z

recessed light; steel, white / plastic, white
Einbauleuchte; Stahl, weiss / Kunststoff, weiss
luminaire encastrable; acier, blanc / plastique, blanc

H 26, Ø 165



10,5W 1520lm Remote, App Ø155 IP20/44



Ø 165



98842

LED



IP20/44

98842 FUEVA-Z

recessed light; aluminium, white / plastic, white
Einbauleuchte; Alu, weiss / Kunststoff, weiss
luminaire encastrable; aluminium, blanc / plastique, blanc

Ø 216, ET 26



16,5W



2100lm



Remote,
App



Ø 205



IP20/44



9 002759 988425



Ø 216



900112



IP20/44

900111



IP20/44



900113



IP20/44



900111 FUEVA-Z

recessed light; steel, satin nickel / plastic, white
Einbauleuchte; Stahl, nickel-matt / Kunststoff, weiss
luminaire encastrable; acier, nickel mat / plastique, blanc

H 26, Ø 85



3x 2,8W



3x 390lm



Remote,
App



Ø 75



IP20/44



Ø 85

900112 FUEVA-Z

recessed light; steel, satin nickel / plastic, white
Einbauleuchte; Stahl, nickel-matt / Kunststoff, weiss
luminaire encastrable; acier, nickel mat / plastique, blanc

H 26, Ø 120



5,4W



800lm



Remote,
App



Ø 105



IP20/44



Ø 120

900113 FUEVA-Z

recessed light; steel, satin nickel / plastic, white
Einbauleuchte; Stahl, nickel-matt / Kunststoff, weiss
luminaire encastrable; acier, nickel mat / plastique, blanc

H 26, Ø 165



10,5W



1520lm



Remote,
App



Ø 155



IP20/44



Ø 165



98844



IP20/44

98844 FUEVA-Z

recessed light; aluminium, satin nickel / plastic, white
 Einbauleuchte; Alu, nickel-matt / Kunststoff, weiss
 luminaire encastrable; aluminium, nickel mat / plastique, blanc

Ø 216, ET 26



16,5W



2100lm



Remote,
App



Ø 205



IP20/44



9 002759 988449



Ø 216



900105



IP20/44



900106



IP20/44



98846



IP20/44



900105 FUEVA-Z

recessed light; steel, black / plastic, white
Einbauleuchte; Stahl, schwarz / Kunststoff, weiss
luminaire encastrable; acier, noir / plastique, blanc

H 26, Ø 85



3x 2,8W



3x 390lm



Remote,
App



Ø 75



IP20/44



9 008606 225613



Ø 85

900106 FUEVA-Z

recessed light; steel, black / plastic, white
Einbauleuchte; Stahl, schwarz / Kunststoff, weiss
luminaire encastrable; acier, noir / plastique, blanc

H 26, Ø 120



5,4W



800lm



Remote,
App



Ø 105



IP20/44



9 008606 225620



Ø 120

98846 FUEVA-Z

recessed light; aluminium, black / plastic, white
Einbauleuchte; Alu, schwarz / Kunststoff, weiss
luminaire encastrable; aluminium, noir / plastique, blanc

Ø 216, ET 26



16,5W



2100lm



Remote,
App



Ø 205



IP20/44



9 002759 988463



Ø 216



900107



IP20/44

900107 FUEVA-Z

recessed light; steel, black / plastic, white

Einbauleuchte; Stahl, schwarz / Kunststoff, weiss

luminaire encastrable; acier, noir / plastique, blanc

H 26, Ø 165



10,5W



1520lm



Remote,
App



Ø 155



IP20/44



9 008606 225637



Ø 165



900104



IP44



900103



IP44



98849



IP44

900104 FUEVA-Z

surface-mounted light; steel, white / plastic, white
Aufbauleuchte; Stahl, weiss / Kunststoff, weiss
luminaire en saillie; acier, blanc / plastique, blanc

L 210, B 210, H 28



16,5W



2250lm



Remote,
App



IP44



98849 FUEVA-Z

surface-mounted light; aluminium, white / plastic, white
Aufbauleuchte; Alu, weiss / Kunststoff, weiss
luminaire en saillie; aluminium, blanc / plastique, blanc

L 285, B 285, H 28



19,5W



2500lm



Remote,
App



IP44



900103 FUEVA-Z

surface-mounted light; steel, white / plastic, white
Aufbauleuchte; Stahl, weiss / Kunststoff, weiss
luminaire en saillie; acier, blanc / plastique, blanc

H 28, Ø 210



16,5W



2250lm



Remote,
App



IP44



9 008606 225606



L 210



9 002759 988494



L 285



9 008606 225590



Ø 210



98843 FUEVA-Z

surface-mounted light; aluminium, white / plastic, white
Aufbauleuchte; Alu, weiss / Kunststoff, weiss
luminaire en saillie; aluminium, blanc / plastique, blanc

H 28, Ø 285

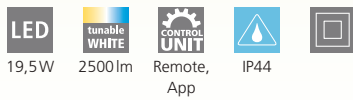

LED

19,5W

tunable
WHITE

2500lm

CONTROL
UNIT

Remote,
App

IP44



98843



IP44



900114



IP44



900115



IP44



98845



IP44

900114 FUEVA-Z

surface-mounted light; steel, satin nickel / plastic, white
Aufbauleuchte; Stahl, nickel-matt / Kunststoff, weiss
luminaire en saillie; acier, nickel mat / plastique, blanc

H 28, Ø 210



16,5W



2250lm



Remote,
App



IP44



98845 FUEVA-Z

surface-mounted light; aluminium, satin nickel / plastic, white
Aufbauleuchte; Alu, nickel-matt / Kunststoff, weiss
luminaire en saillie; aluminium, nickel mat / plastique, blanc

H 28, Ø 285



19,5W



2500lm



Remote,
App



IP44



900115 FUEVA-Z

surface-mounted light; steel, satin nickel / plastic, white
Aufbauleuchte; Stahl, nickel-matt / Kunststoff, weiss
luminaire en saillie; acier, nickel mat / plastique, blanc

L 210, B 210, H 28



16,5W



2250lm



Remote,
App



IP44



9 008606 225699



Ø 210



9 002759 988456



Ø 285



9 008606 225705



L 210



98852 FUEVA-Z

surface-mounted light; aluminium, satin nickel / plastic, white
Aufbauleuchte; Alu, nickel-matt / Kunststoff, weiss
luminaire en saillie; aluminium, nickel mat / plastique, blanc

L 285, B 285, H 28

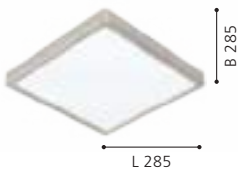
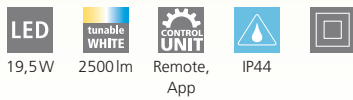

98852



IP44



900108



IP44



98854



IP44



98847



IP44

900108 FUEVA-Z

surface-mounted light; steel, black / plastic, white
Aufbauleuchte; Stahl, schwarz / Kunststoff, weiss
luminaire en saillie; acier, noir / plastique, blanc

H 28, Ø 210



16,5W



2250 lm



Remote,
App



IP44



Ø 210

98847 FUEVA-Z

surface-mounted light; aluminium, black / plastic, white
Aufbauleuchte; Alu, schwarz / Kunststoff, weiss
luminaire en saillie; aluminium, noir / plastique, blanc

H 28, Ø 285



19,5W



2500 lm



Remote,
App



IP44



Ø 285

98854 FUEVA-Z

surface-mounted light; aluminium, black / plastic, white
Aufbauleuchte; Alu, schwarz / Kunststoff, weiss
luminaire en saillie; aluminium, noir / plastique, blanc

L 285, B 285, H 28



19,5W



2500 lm



Remote,
App



IP44



L 285

B 285



9 008606 225644



9 002759 988470



9 002759 988548





900109 FUEVA-Z

surface-mounted light; steel, black / plastic, white
Aufbauleuchte; Stahl, schwarz / Kunststoff, weiss
luminaire en saillie; acier, noir / plastique, blanc

L 210, B 210, H 28

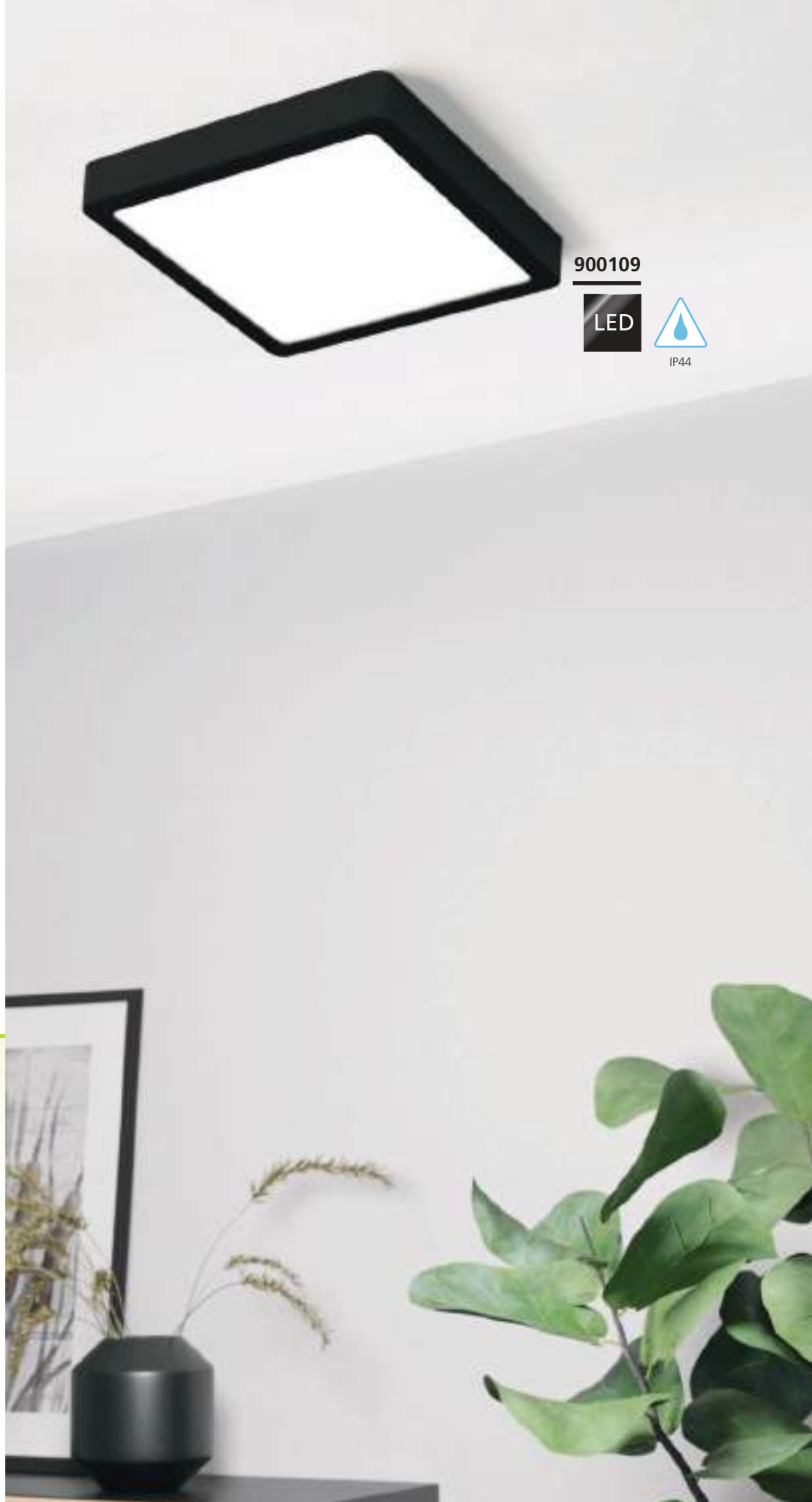
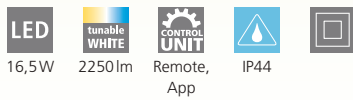

900109



IP44



900001



900002



900636



IP44

900001 TOTARI-Z

ceiling light; steel, white / plastic with crystal effect, white
Deckenleuchte; Stahl, weiss / Kunststoff m. Kristalleffekt, weiss
plafonnier; acier, blanc / plastique avec effet cristal, blanc

H 70, Ø 380



4x 4,8W



2160lm



Remote,
App



900002 TOTARI-Z

ceiling light; steel, white / plastic with crystal effect, white
Deckenleuchte; Stahl, weiss / Kunststoff m. Kristalleffekt, weiss
plafonnier; acier, blanc / plastique avec effet cristal, blanc

H 70, Ø 530



4x 11,2W



4960lm



Remote,
App



900636 TOTARI-Z

ceiling light; steel, white / plastic with crystal effect, white
Deckenleuchte; Stahl, weiss / Kunststoff m. Kristalleffekt, weiss
plafonnier; acier, blanc / plastique avec effet cristal, blanc

H 70, Ø 380



4x 4,8W



2160lm



Remote,
App



IP44



9 008606 221479

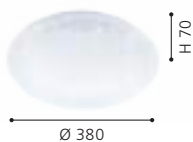

Ø 380



9 008606 221486



Ø 530



9 008606 245208



Ø 380



900084

LED



900085

LED

900084 TOTARI-Z

ceiling light; steel, white / plastic, white
Deckenleuchte; Stahl, weiss / Kunststoff, weiss
plafonnier; acier, blanc / plastique, blanc

H 70, Ø 380



4x 4,8W 2160lm Remote, App



9 008606 225453

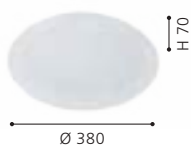

900085 TOTARI-Z

ceiling light; steel, white / plastic, white
Deckenleuchte; Stahl, weiss / Kunststoff, weiss
plafonnier; acier, blanc / plastique, blanc

H 70, Ø 530



4x 11,2W 4960lm Remote, App



9 008606 225460





900083

LED



900005

LED



900006

LED

DIMMABLE
VIA REMOTE
AND APP



900083 LANCIANO-Z

ceiling light; steel, white, transparent / plastic with crystal effect, white, chrome

Deckenleuchte; Stahl, weiss, transparent / Kunststoff m.Kristalleffekt, weiss, chrom

plafonnier; acier, blanc, transparent / plastique avec effet cristal, blanc, chrome
H 80, Ø 450

LED

tunable
WHITE

CONTROL
UNIT



4x 4,8W

2160lm

Remote,
App

900005 LANCIANO-Z

ceiling light; steel, white, transparent / plastic with crystal effect, white, chrome

Deckenleuchte; Stahl, weiss, transparent / Kunststoff m.Kristalleffekt, weiss, chrom

plafonnier; acier, blanc, transparent / plastique avec effet cristal, blanc, chrome
H 80, Ø 560

LED

tunable
WHITE

CONTROL
UNIT



4x 11,2W

4960lm

Remote,
App

900006 LANCIANO-Z

ceiling light; steel, white, transparent / plastic with crystal effect, white, chrome

Deckenleuchte; Stahl, weiss, transparent / Kunststoff m.Kristalleffekt, weiss, chrom

plafonnier; acier, blanc, transparent / plastique avec effet cristal, blanc, chrome
H 95, Ø 770

LED

tunable
WHITE

CONTROL
UNIT



38,1W

5350lm

Remote,
App



9 008606 225446



9 008606 221516



9 008606 221523





900128

LED



900129

LED

900128 SILERAS-Z

ceiling light; steel, white / plastic with crystal effect, white
Deckenleuchte; Stahl, weiss / Kunststoff m.Kristalleffekt, weiss
plafonnier; acier, blanc / plastique avec effet cristal, blanc

H 60, Ø 430



3x 7,2 W



2700lm



Remote,
App



900129 SILERAS-Z

ceiling light; steel, white / plastic with crystal effect, white
Deckenleuchte; Stahl, weiss / Kunststoff m.Kristalleffekt, weiss
plafonnier; acier, blanc / plastique avec effet cristal, blanc

H 60, Ø 600



3x 11 W



4050lm



Remote,
App



9 008606 226054



9 008606 226061





900336

LED



900337

LED



900338

LED



DIMMABLE
VIA REMOTE
AND APP

900336 TELIMBELA-Z

spot; steel, black
Spot; Stahl, schwarz
spot; acier, noir

H 97, Ø 250

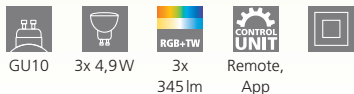

GU10 3x 4,9W 3x 345lm Remote, App

900337 TELIMBELA-Z

spot; steel, black
Spot; Stahl, schwarz
spot; acier, noir

L 580, B 80, H 97

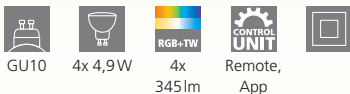

GU10 4x 4,9W 4x 345lm Remote, App

900338 TELIMBELA-Z

spot; steel, white
Spot; Stahl, weiss
spot; acier, blanc

H 97, Ø 250

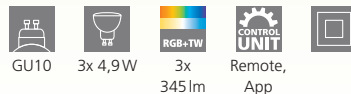

GU10 3x 4,9W 3x 345lm Remote, App



9 008606 239948



9 008606 239955



9 008606 239962





900339

LED

900339 TELIMBELA-Z

spot; steel, white
Spot; Stahl, weiss
spot; acier, blanc

L 580, B 80, H 97



GU10



4x 4,9W



4x
345 lm



Remote,
App



9 008606 239979





99673

LED



99674

LED



99675

LED



99673 CAMINALES-Z

ceiling light; steel, black
Deckenleuchte; Stahl, schwarz
plafonnier; acier, noir

L 125, B 125, H 120



GU10



1x 4,9W



1x
345lm



Remote,
App



99674 CAMINALES-Z

ceiling light; steel, black
Deckenleuchte; Stahl, schwarz
plafonnier; acier, noir

L 240, B 125, H 120



GU10



2x 4,9W



2x
345lm



Remote,
App



99675 CAMINALES-Z

ceiling light; steel, black
Deckenleuchte; Stahl, schwarz
plafonnier; acier, noir

L 240, B 240, H 120



GU10



4x 4,9W



4x
345lm



Remote,
App





99669



99671



99672



99669 SALICETO-Z

recessed light; aluminium, black
Einbauleuchte; Alu, schwarz
luminaire encastrable; aluminium, noir

H 46, Ø 88, ET 50

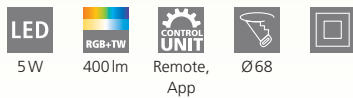

99671 SALICETO-Z

recessed light; aluminium, white
Einbauleuchte; Alu, weiss
luminaire encastrable; aluminium, blanc

H 46, Ø 88, ET 50

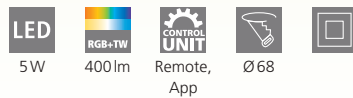

99672 SALICETO-Z

recessed light; aluminium, satin nickel
Einbauleuchte; Alu, nickel-matt
luminaire encastrable; aluminium, nickel mat

H 46, Ø 88, ET 50

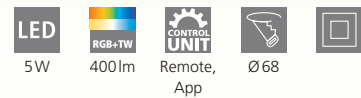



900763

LED



900765

LED

900763 CAROSSO-Z

recessed light; aluminium, black / plastic, white
 Einbauleuchte; Alu, schwarz / Kunststoff, weiss
 luminaire encastrable; aluminium, noir / plastique, blanc

L 93, B 93, H 25

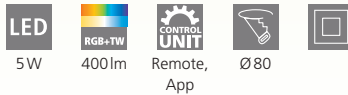

900765 CAROSSO-Z

recessed light; aluminium, white / plastic, white
 Einbauleuchte; Alu, weiss / Kunststoff, weiss
 luminaire encastrable; aluminium, blanc / plastique, blanc

L 93, B 93, H 25

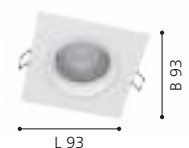
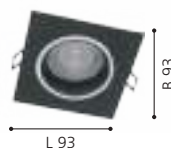
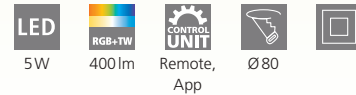



900766



900764



900766 CAROSSO-Z

recessed light; aluminium, white / plastic, white
 Einbauleuchte; Alu, weiss / Kunststoff, weiss
 luminaire encastrable; aluminium, blanc / plastique, blanc

H 28, Ø 93

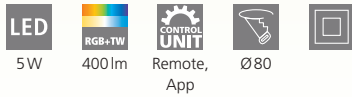

900764 CAROSSO-Z

recessed light; aluminium, black / plastic, white
 Einbauleuchte; Alu, schwarz / Kunststoff, weiss
 luminaire encastrable; aluminium, noir / plastique, blanc

H 28, Ø 93

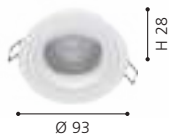
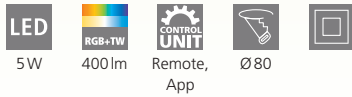

99684

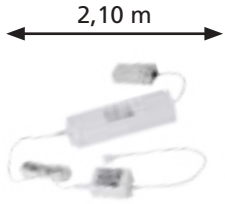

Driver included
Treiber inkludiert
Chauffeur inclus



99684



99685

Extension for starter set 99684 without driver
Erweiterung für Starterset 99684 ohne Treiber
Rallonge pour kit de démarrage 99684 sans pilote



99685



99684 LED STRIPE-Z

bar/strip light; plastic, white
Leuchtband/-stab; Kunststoff, weiss
bande lumineuse / bâton l; plastique, blanc

L 3000, B 8



13,5W 1450lm Remote, App

99685 LED STRIPE-Z

bar/strip light; plastic, white
Leuchtband/-stab; Kunststoff, weiss
bande lumineuse / bâton l; plastique, blanc

L 2000, B 8



9W 950lm Remote, App

DIMMABLE
VIA REMOTE
AND APP



9 002759 996840



L 3000



9 002759 996857



L 2000

99686

1,50 m



Driver included
Treiber inkludiert
Chauffeur inclus



99686

LED

99687

3,40 m



Driver included
Treiber inkludiert
Chauffeur inclus



99687

LED



99686 LED STRIPE-Z

bar/strip light; plastic, white
Leuchtband/-stab; Kunststoff, weiss
bande lumineuse / bâton l; plastique, blanc

L 5000, B 12

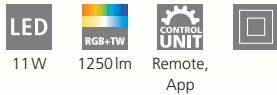

11W 1250lm



9 002759 996864



L 5000

99687 LED STRIPE-Z

bar/strip light; plastic, white
Leuchtband/-stab; Kunststoff, weiss
bande lumineuse / bâton l; plastique, blanc

L 8000, B 12

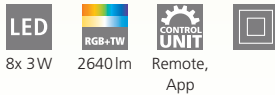

8x 3W 2640lm



9 002759 996871



L 8000





EGLO CONNECT.Z ILLUMINANT

One illuminant – numerous possibilities: 16.7 million colours and over 50,000 white tones ensure the right atmosphere in your home at all times. The illuminant can be controlled via remote control or app using Bluetooth technology: You can control the brightness or adjust colour tones – and all this without complicated installation and comfortably from the sofa.

But the illuminant can do much more: it can be expanded at will using intelligent mesh technology, and up to 50 illuminants can be grouped together. This makes it easy to create and program a wide variety of lighting scenarios. You can also use the app to select from a large number of pre-set lighting scenes.

Security is not neglected either, as the illuminants form a self-contained network and are therefore protected from external access.

EGLO CONNECT.Z LEUCHTMITTEL

Ein Leuchtmittel – zahlreiche Möglichkeiten: 16,7 Millionen Farben und über 50.000 Weißtöne sorgen jederzeit für die richtige Stimmung in Ihrem Heim. Über die Bluetooth-Technologie kann das Leuchtmittel per Fernbedienung oder App gesteuert werden: Sie können die Helligkeit kontrollieren oder Farbtöne einstellen – und das alles ohne aufwändige Installation und bequem vom Sofa aus.

Aber das Leuchtmittel kann noch viel mehr: es lässt sich per intelligenter Mesh-Technologie beliebig erweitern, bis zu 50 Leuchtmittel sind hierbei gruppierbar. So lassen sich problemlos und einfach unterschiedlichste Lichtszenarien erstellen und programmieren. Mit der App können Sie aber auch aus einer Vielzahl vorgegebener Lichtstimmungen auswählen.

Auch die Sicherheit kommt nicht zu kurz, denn die Leuchtmittel bilden ein in sich geschlossenes Netzwerk und sind somit vor Zugriffen von Außen geschützt.

AMPOULE EGLO CONNECT.Z

Une seule ampoule – de nombreuses possibilités : 16,7 millions de couleurs et plus de 50 000 tons de blanc assurent à tout moment la bonne ambiance dans votre maison. L'ampoule peut être commandée via une télécommande ou une appli, utilisant la technologie Bluetooth : Vous pouvez contrôler la luminosité ou régler les tons de couleurs – et tout cela sans installation compliquée et de manière confortablement depuis votre canapé.

Mais l'ampoule peut faire beaucoup plus : elle peut être étendue à volonté grâce à la technologie Mesh intelligentes, et jusqu'à 50 ampoules peuvent être regroupées. Il est ainsi facile de créer et de programmer une grande variété de scène lumineuse. Vous pouvez également utiliser l'appli pour sélectionner un grand nombre d'ambiance lumineuse prédéfinies.

La sécurité n'est pas négligée non plus, car les ampoules forment un réseau fermé et sont donc protégées des accès externes.



12253 E27-LED-A60

806 lm	RGB+TW	2700-6500 K	A++ F
L 118, Ø 60	dimmable via remote & app	9 W	15000 h
220-240V, 50/60Hz	9 W ~ 60 W	E27	80 CRI





12254 E27-LED-G95



1300 lm



2700-6500 K



L 142, Ø 95



dimmable via remote & app



13.5 W



15000 h



220-240V,50/60Hz



13.5 W ~ 88 W



E27



80 CRI



12252 E14-LED-P45



470 lm



2700-6500 K



L 92, Ø 45



dimmable via remote & app



4.9 W



15000 h



220-240V,50/60Hz



4.9 W ~ 35 W



E14



80 CRI



12251 GU10-LED



345 lm



2700-6500 K



L 59, Ø 50



dimmable via remote & app

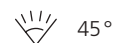

45°



4.9 W



15000 h



220-240V,50/60Hz



4.9 W ~ 50 W



GU10













83 CRI



12226 E27-LED-A60













 806 lm	warm WHITE	2700 K	 A+ G E
 L 105, Ø 60	 dimmable via remote & app		
 6 W	 15000 h		
 220-240V, 50/60Hz	 6 W ~ 60 W		
 E27	 80 CRI		



12227 E27-LED-ST64













 806 lm	warm WHITE	2700 K	 A+ G E
 L 142, Ø 64	 dimmable via remote & app		
 6 W	 15000 h		
 220-240V, 50/60Hz	 6 W ~ 60 W		
 E27	 80 CRI		



12228 E27-LED-G80



 806 lm	warm WHITE	2700 K	 A+ G E
 L 120, Ø 80	 dimmable via remote & app		
 6 W	 15000 h		
 220-240V, 50/60Hz	 6 W ~ 60 W		
 E27	 80 CRI		







12229 E27-LED-G95

 **806 lm**  **warm WHITE** **2700 K**  **A+ G E**

 L 140, Ø 95

 dimmable via remote & app

 6 W

 15000 h

 220-240V,50/60Hz

 6 W ~ 60 W

 E27

 80 CRI



9 002759 122294



12231 E27-LED-A60

 **806 lm**  **neutral WHITE** **4000 K**  **A+ G E**

 L 105, Ø 60

 dimmable via remote & app

 6 W

 15000 h

 220-240V,50/60Hz

 6 W ~ 60 W

 E27

 80 CRI



9 002759 122317



12232 E27-LED-ST64

 **806 lm**  **neutral WHITE** **4000 K**  **A+ G E**

 L 142, Ø 64

 dimmable via remote & app

 6 W

 15000 h

 220-240V,50/60Hz

 6 W ~ 60 W

 E27

 80 CRI



9 002759 122324

12233 E27-LED-G80



806 lm	neutral WHITE	4000 K	E
L 120, Ø 80	dimmable via remote & app		
6 W	15000 h		
220-240V, 50/60Hz	6 W ~ 60 W		
E27	80 CRI		



12234 E27-LED-G95



806 lm	neutral WHITE	4000 K	E
L 140, Ø 95	dimmable via remote & app		
6 W	15000 h		
220-240V, 50/60Hz	6 W ~ 60 W		
E27	80 CRI		



12235 E27-LED-A60



806 lm	tunable WHITE	2200-6500 K	E
L 105, Ø 60	dimmable via remote & app		
6 W	15000 h		
220-240V, 50/60Hz	6 W ~ 60 W		
E27	80 CRI		





12236 E27-LED-ST64

806 lm	tunable WHITE	2200-6500 K	
---------------	----------------------	--------------------	--

L 142, Ø 64	dimmable via remote & app
6 W	15000 h
220-240V,50/60Hz	6 W ~ 60 W
E27	80 CRI



12237 E27-LED-G80

806 lm	tunable WHITE	2200-6500 K	
---------------	----------------------	--------------------	--

L 120, Ø 80	dimmable via remote & app
6 W	15000 h
220-240V,50/60Hz	6 W ~ 60 W
E27	80 CRI



12239 E27-LED-G95

806 lm	tunable WHITE	2200-6500 K	
---------------	----------------------	--------------------	--

L 140, Ø 95	dimmable via remote & app
6 W	15000 h
220-240V,50/60Hz	6 W ~ 60 W
E27	80 CRI



12221 E27-LED-A60



500 lm	warm WHITE 2200 K	A G F
L 105, Ø 60	dimmable via remote & app	
4.9 W	15000 h	
220-240V, 50/60Hz	4.9 W ~ 42 W	
E27	80 CRI	



12222 E27-LED-ST64



500 lm	warm WHITE 2200 K	A G F
L 142, Ø 64	dimmable via remote & app	
4.9 W	15000 h	
220-240V, 50/60Hz	4.9 W ~ 42 W	
E27	80 CRI	



12223 E27-LED-G80



500 lm	warm WHITE 2200 K	A G F
L 120, Ø 80	dimmable via remote & app	
4.9 W	15000 h	
220-240V, 50/60Hz	4.9 W ~ 42 W	
E27	80 CRI	





12224 E27-LED-G95



500 lm

warm
WHITE

2200 K



L 140, Ø 95



dimmable via
remote & app



4.9 W



15000 h



220-240V,50/60Hz



4.9 W ~ 42 W



E27



80 CRI



12225 E27-LED-G125



650 lm

warm
WHITE

2200 K



L 172, Ø 125



dimmable via
remote & app



6 W



15000 h



220-240V,50/60Hz



6 W ~ 51 W



E27











80 CRI



12241 E27-LED-A60



 **360 lm**  **tunable WHITE** **2200-6500 K** 









 L 105, Ø 60	 dimmable via remote & app
 4.9 W	 15000 h
 220-240V, 50/60Hz	 4.9 W ~ 33 W
 E27	 80 CRI



12242 E27-LED-ST64



 **360 lm**  **tunable WHITE** **2200-6500 K** 









 L 142, Ø 64	 dimmable via remote & app
 4.9 W	 15000 h
 220-240V, 50/60Hz	 4.9 W ~ 33 W
 E27	 80 CRI



12243 E27-LED-G80



 **360 lm**  **tunable WHITE** **2200-6500 K** 

 L 120, Ø 80	 dimmable via remote & app
 4.9 W	 15000 h
 220-240V, 50/60Hz	 4.9 W ~ 33 W
 E27	 80 CRI



12244 E27-LED-G95



360 lm



2200-6500 K



L 140, Ø 95



dimmable via remote & app



4.9 W



15000 h



220-240V, 50/60Hz



4.9 W ~ 33 W



E27



80 CRI



12245 E27-LED-G125



360 lm



2200-6500 K



L 170, Ø 125



dimmable via remote & app



4.9 W



15000 h



220-240V, 50/60Hz



4.9 W ~ 33 W



E27



80 CRI



WARM WHITE



COLD WHITE

12255 E27-LED-A60



806 lm	neutral WHITE	4000 K	E
L 105, Ø 60	dimmable via remote & app	2 x AAA Battery included	
6 W	15000 h		
220-240V, 50/60Hz	6 W ~ 60 W		
E27	80 CRI		



12256 E27-LED-ST64



500 lm	warm WHITE	2200 K	F
L 142, Ø 64	dimmable via remote & app	2 x AAA Battery included	
4.9 W	15000 h		
220-240V, 50/60Hz	4.9 W ~ 42 W		
E27	80 CRI		



12257 E27-LED-A60



806 lm	neutral WHITE	4000 K	E
L 105, Ø 60	dimmable via remote & app	3 x AA Battery included	
6 W	15000 h		
220-240V, 50/60Hz	6 W ~ 60 W		
E27	80 CRI		



12258 E27-LED-ST64



500 lm

warm
WHITE

2200 K



L 142, Ø 64



dimmable via
remote & app



3 x AA
Battery included



4.9 W



15000 h



220-240V, 50/60Hz



4.9 W ~ 42 W



E27



80 CRI



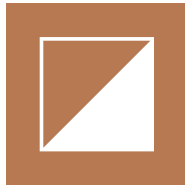

EGLO ACCESS

EGLO ACCESS
EGLO ACCESS



EN EGLO ACCESS

Light influences our lives and our work. For example, bright neutral white light improves focus, while warm, dimmed light makes us feel comfortable. You can adjust your EGLO Access luminaires to your requirements or mood.

DE EGLO ACCESS

Licht beeinflusst unser Leben und unsere Tätigkeiten. Zum Beispiel fördert helles, neutralweißes Licht die Konzentration, wohingegen warmes, gedimmtes Licht uns ein Gefühl von Behaglichkeit gibt. Je nach Anforderung oder Stimmung können Sie Ihre EGLO Access Leuchte individuell einstellen.

FR EGLO ACCÈS

La lumière influence nos vies et nos activités. Par exemple, une lumière blanche brillante et neutre favorise la concentration, tandis qu'une lumière chaude et atténuée nous procure une sensation de confort. En fonction de vos besoins ou de votre humeur, vous pouvez régler votre éclairage EGLO Access.





OVERVIEW

EGLO ACCESS
EGLO ACCESS
EGLO ACCESS



ZUBIETA-A
120-122



FRANIA-A
123



SARSINA-A
124



SALOBRENA-A
126-127



FUEVA-A
128



This product is available in different colors and shapes. / Dieser Artikel ist in unterschiedlichen Farben und Formen verfügbar. / Cet article est disponible en différentes couleurs et formes.





LET LIGHT FOLLOW YOUR LIFE

DAS LICHT, DAS SICH IHREM LEBEN ANPASST
LA LUMIÈRE QUE S'ADAPTE À VOTRE VIE



- › One remote control for different light scenarios
- › 4-predefined settings
- › Tunable white: individually adjustable from warm white to cold white
- › Dimmable with incl. remote control
- › 2 memory functions for individual light

- › Eine Fernbedienung für verschiedene Lichtszenarien
- › 4 vordefinierte Einstellungen
- › Tunable white: individuell einstellbar von Warmweiß bis Kaltweiß
- › Dimmbar mit inkludierter Fernbedienung
- › 2 Speicherfunktionen für individuelles Licht

- › Une seule télécommande pour différents scénarios d'éclairage
- › 4 paramètres prédéfinis à l'emploi
- › Tunable white : réglable individuellement du blanc chaud au blanc froid
- › Graduable avec télécommande incluse
- › 2 fonctions mémoire pour un éclairage individuel

THE SYSTEM'S ADVANTAGES ARE:

DIE VORTEILE DES SYSTEMS SIND:

LES AVANTAGES DU SYSTÈME SONT :



Quick and simple installation

Schnelle und einfache Installation

Installation simple et rapide



One remote control for up to 8 different items and a control distance up to 10 meters.

Eine Fernbedienung für bis zu 8 verschiedene Artikel und steuerbar bis zu 10 Meter

Une seule télécommande pour jusqu'à 8 articles différents et contrôlable jusqu'à 10 mètres



Light colour from 2700K to 6500K

Lichtfarbe von 2700K bis 6500K

Couleur de lumière de 2 700 K à 6 500 K



No internet access necessary

Kein Internetzugang erforderlich

Aucun accès internet nécessaire

FUNCTIONS

FUNKTIONEN FONCTIONS

Relax with warm light and leave the hustle and bustle of everyday life behind you. Concentrate on your work or dispel fatigue, with neutral white light the energy level is replenished. EGLO Access offers these possibilities and many more. All functions and highlights at a glance:

- › It works with radio frequency technology and allows 360 degree control
- › Controllable up to a distance of 10 meters
- › Up to 8 different items can be connected
- › Easy handling thanks to 4 ready-made settings and 2 memory functions

NIGHT LIGHT

RELAX MODE

WORK MODE

SWITCH OFF AFTER 30 MINUTES

Mit warmem Licht entspannen und die Hektik des Alltages hinter sich lassen. Konzentriert arbeiten oder die Müdigkeit vertreiben, mit neutralweißem Licht wird das Energielevel wieder aufgefüllt. Diese Möglichkeiten und noch viele mehr bietet Ihnen EGLO Access. Alle Funktionen und Highlights auf einem Blick:

- › Es arbeitet mit Funktechnologie und ermöglicht eine 360-Grad-Steuerung
- › Steuerbar bis zu einer Entfernung von 10 Metern
- › Bis zu 8 verschiedene Artikel können miteinander verbunden werden
- › Einfache Handhabung durch 4 vorgefertigte Einstellungen und 2 Speicherfunktionen

NACHTLICHT

ENTSPANNUNGSMODUS

ARBEITSMODUS

AUSSCHALTEN NACH 30 MINUTEN

Lumière chaude pour se détendre et laisser l'agitation quotidienne derrière soi. Travailler de manière concentrée ou chasser la fatigue, avec une lumière blanche neutre, le niveau d'énergie est rétabli. EGLO Access vous offre ces possibilités et bien d'autres encore. Toutes les fonctions et les points forts en un coup d'œil :

- › Il fonctionne avec la technologie de la fréquence radio et permet un contrôle à 360 degrés
- › Contrôlable jusqu'à une distance de 10 mètres
- › Jusqu'à 8 articles différents peuvent être connectés ensemble
- › Manipulation facile grâce à 4 réglages prêts à l'emploi et 2 fonctions mémoire

VEILLEUSE

MODE DE DÉCOMPRESSION

MODE DE TRAVAIL

EXTINCTION APRÈS 30 MINUTES

COLOUR TEMPERATURES SCALE / FARBTEMPERATUREN SKALA / ÉCHELLE DES TEMPÉRATURES DE COULEUR



REMOTE CONTROL

FERNBEDIENUNG
TÉLÉCOMMANDE

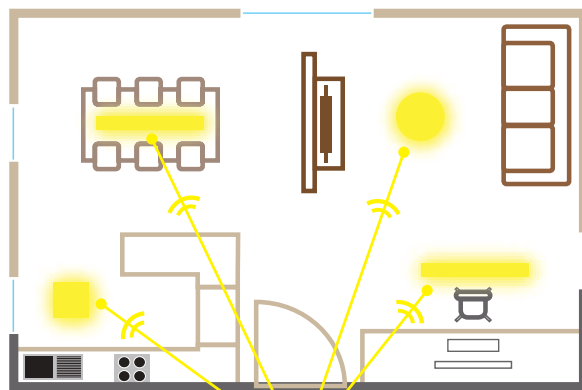
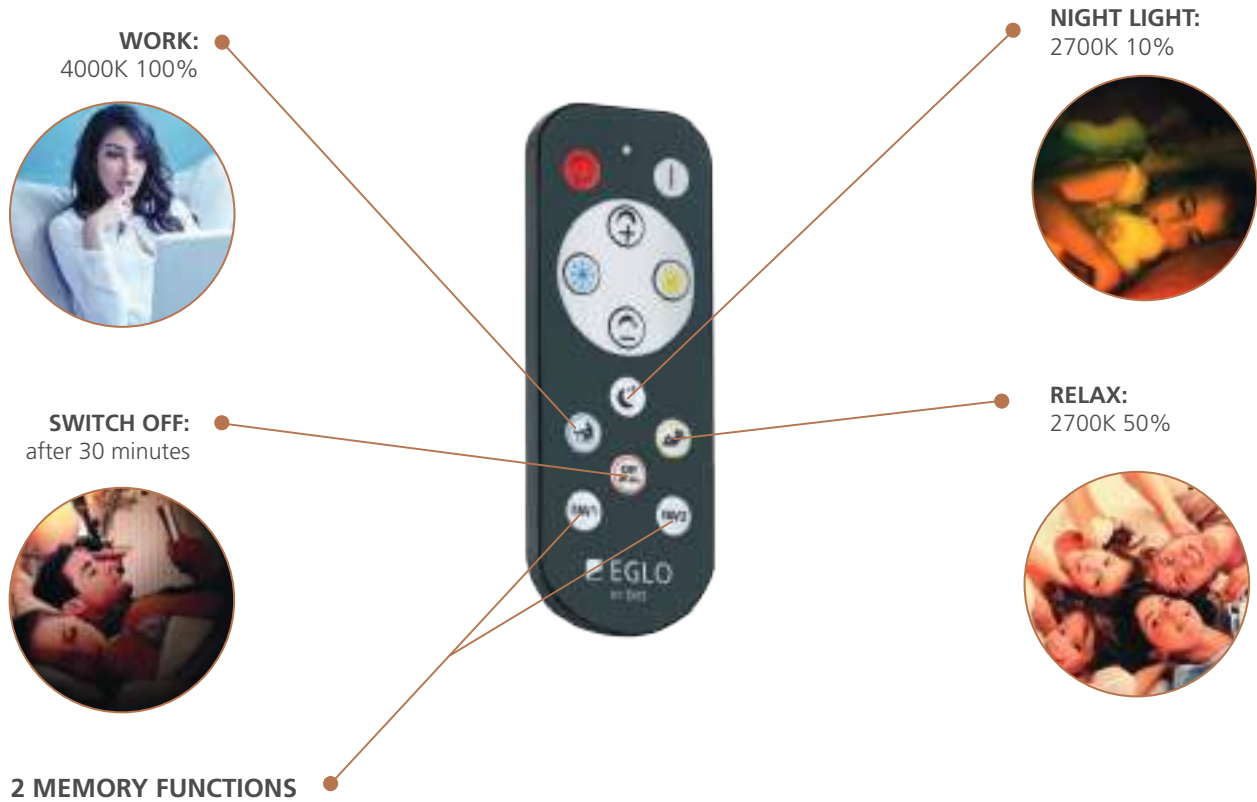

no internet necessary
kein Internet erforderlich
nul besoin d'internet



Control up to 8 EGLO Access luminaires
Bis zu 8 EGLO Access Leuchten steuerbar
Controlé jusqu'à 8 luminaires EGLO Access



98894

LED



98895

LED



98894 ZUBIETA-A

surface-mounted light; steel, black / plastic, white
Aufbauleuchte; Stahl, schwarz / Kunststoff, weiss
luminaire en saillie; acier, noir / plastique, blanc

H 40, Ø 300



14,6W



1900lm



Remote

98895 ZUBIETA-A

surface-mounted light; steel, black / plastic, white
Aufbauleuchte; Stahl, schwarz / Kunststoff, weiss
luminaire en saillie; acier, noir / plastique, blanc

H 40, Ø 450



18,8W



2300lm



Remote

98896 ZUBIETA-A

surface-mounted light; steel, black / plastic, white
Aufbauleuchte; Stahl, schwarz / Kunststoff, weiss
luminaire en saillie; acier, noir / plastique, blanc

H 40, Ø 595



32W



3900lm



Remote



9 002759 988944



Ø 300



9 002759 988951



Ø 450



9 002759 988968



Ø 595



98896

LED

incl./inkl./inclus 





98892



98891



98893



98891 ZUBIETA-A

surface-mounted light; steel, white / plastic, white
Aufbauleuchte; Stahl, weiss / Kunststoff, weiss
luminaire en saillie; acier, blanc / plastique, blanc

H 40, Ø 300



14,6W



1900lm



Remote

98892 ZUBIETA-A

surface-mounted light; steel, white / plastic, white
Aufbauleuchte; Stahl, weiss / Kunststoff, weiss
luminaire en saillie; acier, blanc / plastique, blanc

H 40, Ø 450



18,8W



2300lm



Remote

98893 ZUBIETA-A

surface-mounted light; steel, white / plastic, white
Aufbauleuchte; Stahl, weiss / Kunststoff, weiss
luminaire en saillie; acier, blanc / plastique, blanc

H 40, Ø 595



32W



3900lm



Remote



9 002759 988913



9 002759 988920



9 002759 988937





98294



IP44



incl./inkl./inclus



98236



incl./inkl./inclus



98237



incl./inkl./inclus

98294 FRANIA-A

wall/ceiling light; steel, white / plastic with crystal effect, white
Wand- / Deckenleuchte; Stahl, weiss / Kunststoff m.Kristalleffekt, weiss
Applique/Plafonnier; acier, blanc / plastique avec effet cristal, blanc

H 55, Ø 300



12W



1050lm



Remote



IP44

98236 FRANIA-A

wall/ceiling light; steel, white / plastic with crystal effect, white
Wand- / Deckenleuchte; Stahl, weiss / Kunststoff m.Kristalleffekt, weiss
Applique/Plafonnier; acier, blanc / plastique avec effet cristal, blanc

H 55, Ø 400



19W



2400lm



Remote

98237 FRANIA-A

wall/ceiling light; steel, white / plastic with crystal effect, white
Wand- / Deckenleuchte; Stahl, weiss / Kunststoff m.Kristalleffekt, weiss
Applique/Plafonnier; acier, blanc / plastique avec effet cristal, blanc

H 75, Ø 570



32,5W



3900lm



Remote



9 002759 982942



Ø 300



9 002759 982362



Ø 400



9 002759 982379



Ø 570



98207



98208



98207 SARSINA-A

ceiling light; aluminium, white / plastic, white
Deckenleuchte; Alu, weiss / Kunststoff, weiss
plafonnier; aluminium, blanc / plastique, blanc

H 50, Ø 300



14W



2000lm



Remote



98208 SARSINA-A

ceiling light; aluminium, white / plastic, white
Deckenleuchte; Alu, weiss / Kunststoff, weiss
plafonnier; aluminium, blanc / plastique, blanc

H 50, Ø 450



21,5W



2850lm



Remote



98209 SARSINA-A

ceiling light; aluminium, white / plastic, white
Deckenleuchte; Alu, weiss / Kunststoff, weiss
plafonnier; aluminium, blanc / plastique, blanc

H 50, Ø 600



30W



4000lm



Remote



9 002759 982072

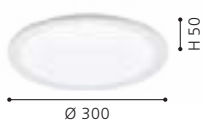

9 002759 982089

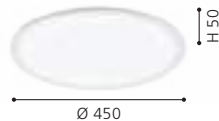

9 002759 982096





98209

LED

incl./inkl./inclus





98205

LED



incl./inkl./inclus



98206

LED



incl./inkl./inclus



98205 SALOBRENA-A

ceiling light; aluminium, white / plastic, white
Deckenleuchte; Alu, weiss / Kunststoff, weiss
plafonnier; aluminium, blanc / plastique, blanc

L 1200, B 300, H 50



31,5W 3900lm Remote

98206 SALOBRENA-A

ceiling light; aluminium, white / plastic, white
Deckenleuchte; Alu, weiss / Kunststoff, weiss
plafonnier; aluminium, blanc / plastique, blanc

L 1195, B 100, H 50



30W 3900lm Remote

98297 SALOBRENA-A

ceiling light; aluminium, white / plastic, white
Deckenleuchte; Alu, weiss / Kunststoff, weiss
plafonnier; aluminium, blanc / plastique, blanc

L 450, B 450, H 50



20W 2600lm Remote



9 002759 982058



9 002759 982065

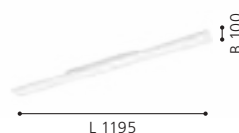

9 002759 982973

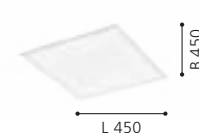



98297



98201



98203



98201 SALOBRENA-A

ceiling light; aluminium, white / plastic, white
Deckenleuchte; Alu, weiss / Kunststoff, weiss
plafonnier; aluminium, blanc / plastique, blanc

L 300, B 300, H 50



98203 SALOBRENA-A

ceiling light; aluminium, white / plastic, white
Deckenleuchte; Alu, weiss / Kunststoff, weiss
plafonnier; aluminium, blanc / plastique, blanc

L 600, B 600, H 50



9 002759 982010



9 002759 982034

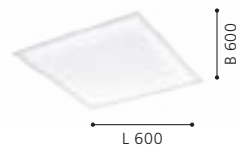



98292

LED



FUEVA-A

These luminaires inspire with their extremely flat and elegant design.

Diese Leuchten begeistern durch ihre extrem flache und elegante Bauweise.

Ces lumières enthousiasment par la méthode de construction extrêmement plate et élégante.



98293

LED



98292 FUEVA-A

surface-mounted light; aluminium, white / plastic, white
 Aufbauleuchte; Alu, weiss / Kunststoff, weiss
 luminaire en saillie; aluminium, blanc / plastique, blanc

H 30, Ø 225



98293 FUEVA-A

surface-mounted light; aluminium, white / plastic, white
 Aufbauleuchte; Alu, weiss / Kunststoff, weiss
 luminaire en saillie; aluminium, blanc / plastique, blanc

H 30, Ø 300



98212 FUEVA-A

recessed light; aluminium, white / plastic, white
 Einbauleuchte; Alu, weiss / Kunststoff, weiss
 luminaire encastrable; aluminium, blanc / plastique, blanc

Ø 120, ET 30

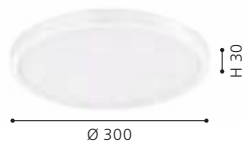



98212

LED

incl./inkl./inclus





LIGHTING FAMILIES / FABRIC LUMINAIRES

LEUCHTENFAMILIEN / STOFFLEUCHTEN
FAMILLES DE LUMINAIRES / LUMINAIRES À TEXTIL

EN **SIMPLE CLASSINESS**

The textile luminaires with their unusual designs are perfectly trendy and bring cosiness to every home. Selected textiles in natural shades and clear shapes form the basis of a friendly and tasteful living environment in our textile luminaires. Inner coatings in sophisticated gold and classical silver add an air of luxury.

DE **SCHLICHTE ELEGANZ**

Die Stoffleuchten mit ihrem außergewöhnlichen Design sind voll im Trend und sorgen für Gemütlichkeit in jedem Zuhause. Bei den Stoffleuchten bilden ausgesuchte Stoffe in Naturtönen und klaren Formgebungen die Grundlage für eine freundliche und geschmackvolle Wohnumgebung. Für einen Hauch von Luxus sorgen die Innenbeschichtungen in edlem Gold und klassischem Silber.

FR **ÉLÉGANCE SIMPLE**

Les luminaires en étoffe avec leur design extraordinaire sont très tendance et assurent un confort dans chaque maison. Chez les luminaires en étoffe, des étoffes sélectionnées dans des tons naturels et des formes claires forment la base d'un cadre de vie convivial et de bon goût. Les revêtements internes en or fin et en argent classique ajoutent une touche de luxe.





OVERVIEW

LIGHTING FAMILIES / FABRIC LUMINAIRS
LEUCHTENFAMILIEN / STOFFLEUCHTEN
FAMILLES DE LUMINAIRES / LUMINAIRES À TEXTIL

 ROMAO 1 136	 ROMAO 136-137	 ROMAO 3 136-137	 PASTERI 138-141,146-161	 PALOMARO 142-143	 PALOMARO 1 143	 PASTORE 144	 PASTORE 1 144
 PASTORE 2 145	 VISERBELLA 162-164	 ESTEPERRA 166-169	 VARILLAS 171	 MARASALES 172-174	 ZARAGOZA 176-177	 BUCAMARANGA 178	 MASERLO 180-181,184-193
 MASERLO 2 180, 186, 189, 192	 MASERLO 1 182-183	 CONCESSA 1 194-195	 ALBARIZA 196	 FENIGLIA 198-199	 ALMEIDA 2 200-201	 NASTASIA 202	 AGLIENTINA 203
 ALMEIDA 1 204	 ALMEIDA 205	 MARONDA 205					



This product is available in different colors and shapes. / Dieser Artikel ist in unterschiedlichen Farben und Formen verfügbar. / Cet article est disponible en différentes couleurs et formes.



Lighting Families / Wood luminaires starts on page 206.
Leuchtenfamilien / Holzleuchten starten auf Seite 206.
Familles d'éclairage / Luminaires à bois commence à la page 206.



Lighting Families / Essential luminaires starts on page 228.
Leuchtenfamilien / Standardleuchten starten auf Seite 228.
Familles d'éclairage / Luminaires standard commence à la page 228.



Lighting Families / Glass chandeliers starts on page 336.
Leuchtenfamilien / Glasluster starten auf Seite 336.
Familles d'éclairage / lustres en verre commence à la page 336.



FABRIC MATERIALS

STOFF MATERIALIEN
MATÉRIAUX EN TISSU

SHADES / SCHIRME / OMBRES

GLOSSY / GLÄNZEND / GLOSSY



fabric, glossy black
Textil, samtglänzend schwarz
tissu, velours noir brillant



fabric, glossy taupe
Textil, samtglänzend taupe
tissu, velours taupe brillant



fabric, glossy cappucino
Textil, samtglänzend cappucino
tissu, velours cappucino brillant



fabric, glossy grey
Textil, samtglänzend grau
tissu, velours gris brillant



fabric, glossy white
Textil, samtglänzend weiß
tissu, velours blanc brillant



fabric, glossy gold
Textil, samtglänzend gold
tissu, velours or brillant

MAT / MATT / MAT



fabric, mat black
Textil, matt schwarz
tissu, tapis noir



fabric, mat taupe
Textil, matt taupe
tissu, tapis taupe



fabric, mat anthracite-brown
Textil, matt anthrazit-braun
tissu, tapis anthracite-marron



fabric, mat grey
Textil, matt grau
tissu, tapis gris



fabric, mat white
Textil, matt weiß
tissu, tapis blanc



fabric, mat white & gold
Textil, matt weiß & gold
tissu, tapis blanc & or

LINEN / LEINEN / LIN



linen, grey
Leinen, grau
lin, gris



linen, brown
Leinen, braun
lin, marron

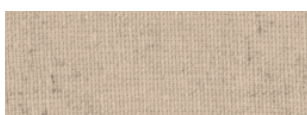

linen, natural
Leinen, natur
lin, nature

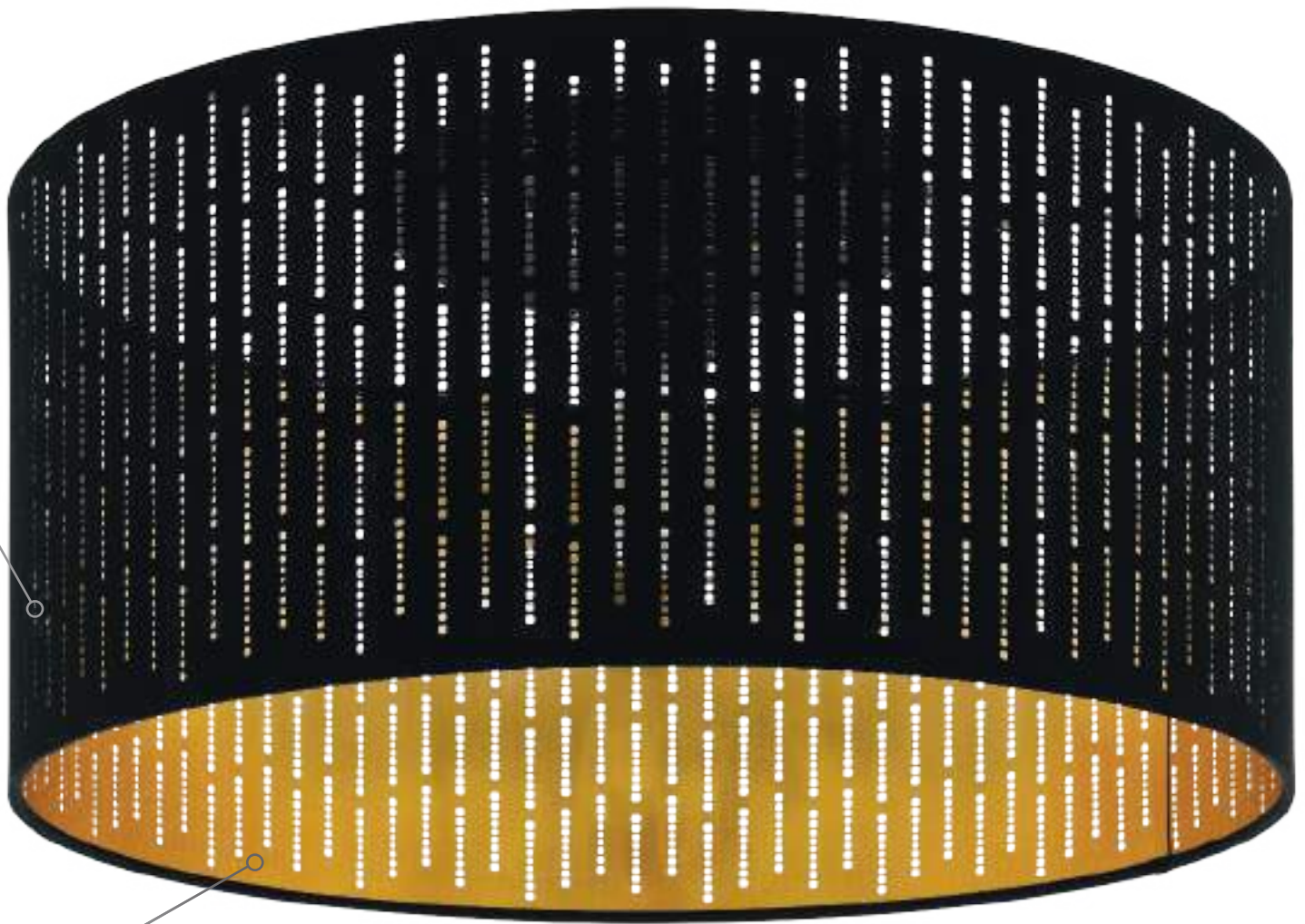

COATING / BESCHICHTUNG / REVÊTEMENT



coating, silver
Beschichtung, silber
revêtement, argent

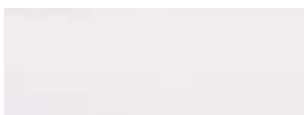

coating, white
Beschichtung, weiß
revêtement, blanc



coating, black
Beschichtung, schwarz
revêtement, noir



coating, gold
Beschichtung, gold
revêtement, or



coating, copper
Beschichtung, kupfer
revêtement, coivre



coating, brass
Beschichtung, messing
revêtement, laiton



coating, brass & white
Beschichtung, messing & weiß
revêtement, laiton & blanc



97777

LED

incl./inkl./inclus



97778

LED

incl./inkl./inclus



97779

LED

incl./inkl./inclus

97777 ROMAO 1

ceiling light; steel, white / fabric, plastic, white
Deckenleuchte; Stahl, weiss / Textil, Kunststoff, weiss
plafonnier; acier, blanc / tissu, plastique, blanc

H 120, Ø 570

LED

36W

tunable
WHITE

4300lm



CONTROL
UNIT

Remote

97779 ROMAO

ceiling light; steel, white / fabric linen, plastic, grey, white
Deckenleuchte; Stahl, weiss / Textil Leinen, Kunststoff, grau,
weiss
plafonnier; acier, blanc / tissu de lin, plastique, gris, blanc

H 120, Ø 570

LED

36W

tunable
WHITE

4300lm



CONTROL
UNIT

Remote

97778 ROMAO 3

ceiling light; steel, white / fabric, plastic, taupe, white
Deckenleuchte; Stahl, weiss / Textil, Kunststoff, taupe, weiss
plafonnier; acier, blanc / tissu, plastique, taupe, blanc

H 120, Ø 570

LED

36W

tunable
WHITE

4300lm



CONTROL
UNIT

Remote



9 002759 977771



9 002759 977795



9 002759 977788





97783



97784



TUNABLE WHITE 3000 - 5000K	DIMMABLE 10 - 100%	TIMER FUNCTION off after 30sec.	NIGHT LIGHT FUNCTION	<u>97777</u>	<u>97783</u>
				<u>97778</u>	<u>97784</u>
				<u>97779</u>	

see page / siehe Seite / voir la page 478

97784 ROMAO

ceiling light; steel, white / fabric linen, plastic, grey, white
Deckenleuchte; Stahl, weiss / Textil Leinen, Kunststoff, grau, weiss
plafonnier; acier, blanc / tissu de lin, plastique, gris, blanc

H 120, Ø 760



97783 ROMAO 3

ceiling light; steel, white / fabric, plastic, taupe, white
Deckenleuchte; Stahl, weiss / Textil, Kunststoff, taupe, weiss
plafonnier; acier, blanc / tissu, plastique, taupe, blanc

H 120, Ø 760



9 002759 977849



9 002759 977832

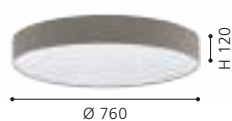



97611



97615



97619

97611 PASTERI

ceiling light; steel, white / fabric, white
Deckenleuchte; Stahl, weiss / Textil, weiss
plafonnier; acier, blanc / tissu, blanc

H 150, Ø 570



E27



3x 25W

97615 PASTERI

ceiling light; steel, white / fabric, white
Deckenleuchte; Stahl, weiss / Textil, weiss
plafonnier; acier, blanc / tissu, blanc

H 150, Ø 760



E27



5x 25W

97619 PASTERI

ceiling light; steel, white / fabric, white
Deckenleuchte; Stahl, weiss / Textil, weiss
plafonnier; acier, blanc / tissu, blanc

H 170, Ø 980



E27



7x 25W



9 002759 976118



9 002759 976156



9 002759 976194





97613



97617



97613 PASTERI

ceiling light; steel, white / fabric, linen, grey, white
Deckenleuchte; Stahl, weiss / Textil, Leinen, grau, weiss
plafonnier; acier, blanc / tissu, lin, gris, blanc

H 150, Ø 570



9 002759 976132



97617 PASTERI

ceiling light; steel, white / fabric, linen, grey, white
Deckenleuchte; Stahl, weiss / Textil, Leinen, grau, weiss
plafonnier; acier, blanc / tissu, lin, gris, blanc

H 150, Ø 760



9 002759 976170





97614



97618



97614 PASTERI

ceiling light; steel, white / fabric, linen, brown, white
Deckenleuchte; Stahl, weiss / Textil, Leinen, braun, weiss
plafonnier; acier, blanc / tissu, lin, marron, blanc

H 150, Ø 570



9 002759 976149



97618 PASTERI

ceiling light; steel, white / fabric, linen, brown, white
Deckenleuchte; Stahl, weiss / Textil, Leinen, braun, weiss
plafonnier; acier, blanc / tissu, lin, marron, blanc

H 150, Ø 760



9 002759 976187





97612 PASTERI

ceiling light; steel, white / fabric, taupe, white
Deckenleuchte; Stahl, weiss / Textil, taupe, weiss
plafonnier; acier, blanc / tissu, taupe, blanc

H 150, Ø 570



97616 PASTERI

ceiling light; steel, white / fabric, taupe, white
Deckenleuchte; Stahl, weiss / Textil, taupe, weiss
plafonnier; acier, blanc / tissu, taupe, blanc

H 150, Ø 760



97621 PASTERI

ceiling light; steel, white / fabric, taupe, white
Deckenleuchte; Stahl, weiss / Textil, taupe, weiss
plafonnier; acier, blanc / tissu, taupe, blanc

H 170, Ø 980





93397

LED

93397 PALOMARO

ceiling light; plastic, white / fabric, anthracite
Deckenleuchte; Kunststoff, weiss / Textil, anthrazit
plafonnier; plastique, blanc / tissu, anthracite

H 110, Ø 500

LED

warm
WHITE



4x 5,4W 2200lm



9 002759 933975

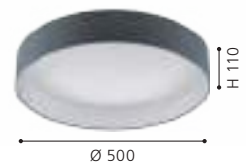



99508



99509



PASTORE | PASTORE 1
PASTORE 2

99508 PASTORE 2

ceiling light; steel, white / fabric, black, white
Deckenleuchte; Stahl, weiss / Textil, schwarz, weiss
plafonnier; acier, blanc / tissu, noir, blanc

L 610, B 495, H 255



E27



3x 60W



9 002759 995089



99509 PASTORE 2

ceiling light; steel, white / fabric, black, white
Deckenleuchte; Stahl, weiss / Textil, schwarz, weiss
plafonnier; acier, blanc / tissu, noir, blanc

H 285, Ø 990



E27



6x 40W



9 002759 995096



DESIGN
HIGHLIGHT
DETAIL



97479



97838



98409

97479 PASTORE

ceiling light; steel, white / fabric, anthracite-brown, white, grey
Deckenleuchte; Stahl, weiss / Textil, anthrazit-braun, weiss, grau
plafonnier; acier, blanc / tissu, marron anthracite, blanc, gri

L 610, B 495, H 255



E27



3x 60W

97838 PASTORE

ceiling light; steel, white / fabric, brown, grey, white, black
Deckenleuchte; Stahl, weiss / Textil, braun, grau, weiss, schwarz
plafonnier; acier, blanc / tissu, marron, gris, blanc, noir

H 285, Ø 990



E27



6x 40W

98409 PASTORE 1

ceiling light; steel, white / fabric, taupe
Deckenleuchte; Stahl, weiss / Textil, taupe
plafonnier; acier, blanc / tissu, taupe

H 250, Ø 990



E27



6x 40W



9 002759 974794



L 610



9 002759 978389



Ø 990



9 002759 984090



Ø 990



99508



99509



PASTORE | PASTORE 1
PASTORE 2

99508 PASTORE 2

ceiling light; steel, white / fabric, black, white
Deckenleuchte; Stahl, weiss / Textil, schwarz, weiss
plafonnier; acier, blanc / tissu, noir, blanc

L 610, B 495, H 255



E27



3x 60W



9 002759 995089



L 610

99509 PASTORE 2

ceiling light; steel, white / fabric, black, white
Deckenleuchte; Stahl, weiss / Textil, schwarz, weiss
plafonnier; acier, blanc / tissu, noir, blanc

H 285, Ø 990



E27



6x 40W



9 002759 995096



Ø 990

DESIGN
HIGHLIGHT
DETAIL



31581



31572

31581 PASTERI

pendant light; steel, satin nickel / fabric, taupe
 Hängeleuchte; Stahl, nickel-matt / Textil, taupe
 luminaire en suspension; acier, nickel mat / tissu, taupe

L 750, B 220, H 1100



E27 2x 60W

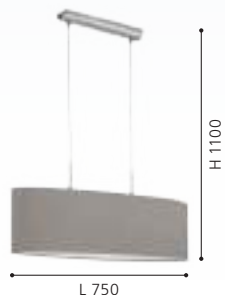

31572 PASTERI

pendant light; steel, satin nickel / fabric, taupe
 Hängeleuchte; Stahl, nickel-matt / Textil, taupe
 luminaire en suspension; acier, nickel mat / tissu, taupe

H 1100, Ø 380



E27 1x 60W



31589 PASTERI

ceiling light; plastic, steel, white / fabric, taupe
 Deckenleuchte; Kunststoff, Stahl, weiss / Textil, taupe
 plafonnier; plastique, acier, blanc / tissu, taupe

H 90, Ø 320



LED warm WHITE 3x 3,6W 1110lm





31589

LED

31576 PASTERI

pendant light; steel, satin nickel / fabric, taupe
Hängeleuchte; Stahl, nickel-matt / Textil, taupe
luminaire en suspension; acier, nickel mat / tissu, taupe

H 1100, Ø 530



E27



1x 60W



9 002759 315764



31576



94919



94919 PASTERI

ceiling light; steel, satin nickel / fabric, glass, taupe
Deckenleuchte; Stahl, nickel-matt / Textil, Glas, taupe
plafonnier; acier, nickel mat / tissu, verre, taupe

H 195, Ø 475



94925 PASTERI

wall light; steel, satin nickel / fabric, taupe
Wandleuchte; Stahl, nickel-matt / Textil, taupe
Applique; acier, nickel mat / tissu, taupe

L 145, H 305, A 195

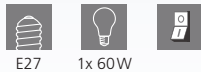

96478 PASTERI

wall light; steel, satin nickel / fabric, taupe
Wandleuchte; Stahl, nickel-matt / Textil, taupe
Applique; acier, nickel mat / tissu, taupe

L 150, H 380, A 195

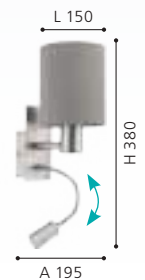



31595



95167

31595 PASTERI

table light; steel, satin nickel / fabric, taupe
Tischleuchte; Stahl, nickel-matt / Textil, taupe
luminaire de table; acier, nickel mat / tissu, taupe

H 400, Ø 180, Base: Ø 150

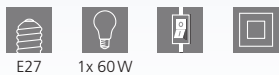

E27 1x 60W



9 002759 315955

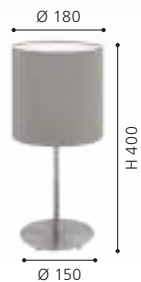

95167 PASTERI

floor light; steel, satin nickel / fabric, taupe
Stehleuchte; Stahl, nickel-matt / Textil, taupe
lampadaire; acier, nickel mat / tissu, taupe

H 1575, Ø 280, Base: Ø 230



E27 1x 60W



9 002759 951672





31592

LED



31582

31592 PASTERI

ceiling light; plastic, steel, white / fabric, grey
 Deckenleuchte; Kunststoff, Stahl, weiss / Textil, grau
 plafonnier; plastique, acier, blanc / tissu, gris

H 90, Ø 320



3x 3,6W 1110lm



9 002759 315924



31582 PASTERI

pendant light; steel, satin nickel / fabric, grey
 Hängeleuchte; Stahl, nickel-matt / Textil, grau
 luminaire en suspension; acier, nickel mat / tissu, gris

L 750, B 220, H 1100

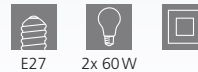

E27 2x 60W



9 002759 315825





94921



31573



31577

94921 PASTERI

ceiling light; steel, satin nickel / fabric, glass, grey
Deckenleuchte; Stahl, nickel-matt / Textil, Glas, grau
plafonnier; acier, nickel mat / tissu, verre, gris

H 195, Ø 475



31577 PASTERI

pendant light; steel, satin nickel / fabric, grey
Hängeleuchte; Stahl, nickel-matt / Textil, grau
luminaire en suspension; acier, nickel mat / tissu, gris

H 1100, Ø 530



31573 PASTERI

pendant light; steel, satin nickel / fabric, grey
Hängeleuchte; Stahl, nickel-matt / Textil, grau
luminaire en suspension; acier, nickel mat / tissu, gris

H 1100, Ø 380





94926



96479

LED

94926 PASTERI

wall light; steel, satin nickel / fabric, grey
 Wandleuchte; Stahl, nickel-matt / Textil, grau
 Applique; acier, nickel mat / tissu, gris

L 145, H 305, A 195

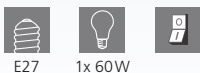

E27 1x 60W



9 002759 949266



96479 PASTERI

wall light; steel, satin nickel / fabric, grey
 Wandleuchte; Stahl, nickel-matt / Textil, grau
 Applique; acier, nickel mat / tissu, gris

L 150, H 380, A 195



E27 1x 40W 1x 3,8W 320lm



9 002759 964795

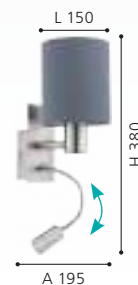



95119



95119

These luminaires can be switched on and off by touching the specially designed "Touch Me" part of the fixture.

Diese Leuchten können ein- und ausgeschaltet werden, indem man sie an den dafür vorgesehenen „Touch Me“ Bereichen berührt.

Ces luminaires peuvent être éteints et allumés simplement en touchant la partie spécialement conçue pour «Touch Me» du luminaire.



31596



95166

95119 PASTERI

table light; steel, satin nickel / fabric, grey
Tischleuchte; Stahl, nickel-matt / Textil, grau
luminaire de table; acier, nickel mat / tissu, gris

H 255, Ø 120



E27 1x 40W



9 002759 951191



Ø 120

31596 PASTERI

table light; steel, satin nickel / fabric, grey
Tischleuchte; Stahl, nickel-matt / Textil, grau
luminaire de table; acier, nickel mat / tissu, gris

H 400, Ø 180, Base: Ø 150

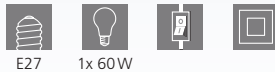

E27 1x 60W



9 002759 315962



Ø 150

95166 PASTERI

floor light; steel, satin nickel / fabric, grey
Stehleuchte; Stahl, nickel-matt / Textil, grau
lampadaire; acier, nickel mat / tissu, gris

H 1575, Ø 280, Base: Ø 230



E27 1x 60W



9 002759 951665



Ø 230



31574





31578



96481

The main and reading lights can be switched on separately.

Das Haupt- und das Leselicht können getrennt voneinander geschaltet werden.

Les luminaires principales et de lecture peuvent être allumées séparément.

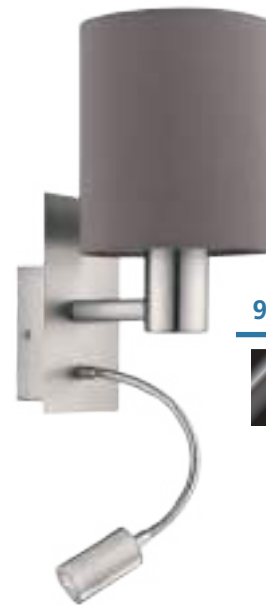

96481

LED

31574 PASTERI

pendant light; steel, satin nickel / fabric, anthracite-brown
Hängeleuchte; Stahl, nickel-matt / Textil, anthrazit-braun
luminaire en suspension; acier, nickel mat / tissu, marron anthracite

H 1100, Ø 380



31578 PASTERI

pendant light; steel, satin nickel / fabric, anthracite-brown
Hängeleuchte; Stahl, nickel-matt / Textil, anthrazit-braun
luminaire en suspension; acier, nickel mat / tissu, marron anthracite

H 1100, Ø 530



96481 PASTERI

wall light; steel, satin nickel / fabric, anthracite-brown
Wandleuchte; Stahl, nickel-matt / Textil, anthrazit-braun
Applique; acier, nickel mat / tissu, marron anthracite

L 150, H 380, A 195

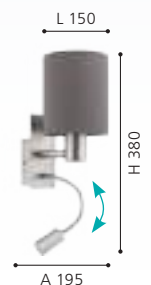



31571

31571 PASTERI

pendant light; steel, satin nickel / fabric, white
Hängeleuchte; Stahl, nickel-matt / Textil, weiss
luminaire en suspension; acier, nickel mat / tissu, blanc

H 1100, Ø 380



E27



1x 60W



9 002759 315719

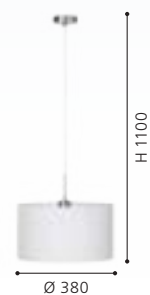



31575 PASTERI

pendant light; steel, satin nickel / fabric, white
 Hängeleuchte; Stahl, nickel-matt / Textil, weiss
 luminaire en suspension; acier, nickel mat / tissu, blanc

H 1100, Ø 530



94918 PASTERI

ceiling light; steel, satin nickel / fabric, glass, white
 Deckenleuchte; Stahl, nickel-matt / Textil, Glas, weiss
 plafonnier; acier, nickel mat / tissu, verre, blanc

H 195, Ø 475



31588 PASTERI

ceiling light; plastic, steel, white / fabric, white
 Deckenleuchte; Kunststoff, Stahl, weiss / Textil, weiss
 plafonnier; plastique, acier, blanc / tissu, blanc

H 90, Ø 320

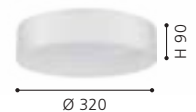



94924



95118



96477

LED

95118

These luminaires can be switched on and off by touching the specially designed "Touch Me" part of the fixture.

Diese Leuchten können ein- und ausgeschaltet werden, indem man sie an den dafür vorgesehenen „Touch Me“ Bereichen berührt.

Ces luminaires peuvent être éteints et allumés simplement en touchant la partie spécialement conçue pour «Touch Me» du luminaire.



96477 PASTERI

wall light; steel, satin nickel / fabric, white
Wandleuchte; Stahl, nickel-matt / Textil, weiss
Applique; acier, nickel mat / tissu, blanc

L 150, H 380, A 195

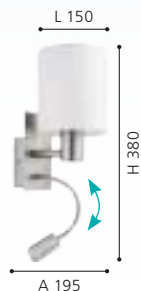

94924 PASTERI

wall light; steel, satin nickel / fabric, white
Wandleuchte; Stahl, nickel-matt / Textil, weiss
Applique; acier, nickel mat / tissu, blanc

L 145, H 305, A 195

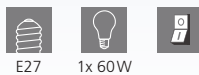

95118 PASTERI

table light; steel, satin nickel / fabric, white
Tischleuchte; Stahl, nickel-matt / Textil, weiss
luminaire de table; acier, nickel mat / tissu, blanc

H 255, Ø 120

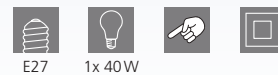



31594



95164

31594 PASTERI

table light; steel, satin nickel / fabric, white
Tischleuchte; Stahl, nickel-matt / Textil, weiss
luminaire de table; acier, nickel mat / tissu, blanc

H 400, Ø 180, Base: Ø 150

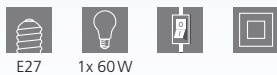

9 002759 315948



95164 PASTERI

floor light; steel, satin nickel / fabric, white
Stehleuchte; Stahl, nickel-matt / Textil, weiss
lampadaire; acier, nickel mat / tissu, blanc

H 1575, Ø 280, Base: Ø 230



9 002759 951641

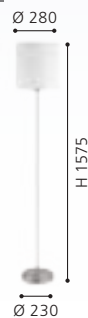



95045



96484

LED



95045 PASTERI

pendant light; steel, satin nickel / fabric, white, copper
 Hängeleuchte; Stahl, nickel-matt / Textil, weiss, kupfer
 luminaire en suspension; acier, nickel mat / tissu, blanc, cuivre

H 1100, Ø 530



96484 PASTERI

wall light; steel, satin nickel / fabric, white, copper
 Wandleuchte; Stahl, nickel-matt / Textil, weiss, kupfer
 Applique; acier, nickel mat / tissu, blanc, cuivre

L 150, H 380, A 195





900701

LED



96483

LED

900701 PASTERI

wall light; steel, black / fabric, anthracite-brown
Wandleuchte; Stahl, schwarz / Textil, anthrazit-braun
Applique; acier, noir / tissu, marron anthracite

L 150, H 380, A 195



E27 1x 40W 1x 3,8W 320lm



9 008606 251728

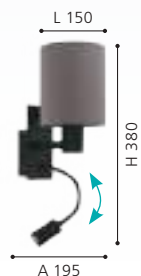

96483 PASTERI

wall light; steel, satin nickel / fabric, black, copper
Wandleuchte; Stahl, nickel-matt / Textil, schwarz, kupfer
Applique; acier, nickel mat / tissu, noir, cuivre

L 150, H 380, A 195



E27 1x 40W 1x 3,8W 320lm



9 002759 964832

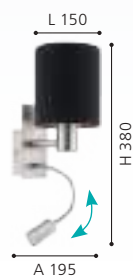

96483, 96484, 900701

The main and reading lights can be switched on separately.

Das Haupt- und das Leselicht können getrennt voneinander geschaltet werden.

Les luminaires principales et de lecture peuvent être allumées séparément.



97643



97644

97643 VISERBELLA

pendant light; steel, champagne / fabric, gold
 Hängeleuchte; Stahl, champagner / Textil, gold
 luminaire en suspension; acier, champagne / tissu, doré

H 1100, Ø 380



9 002759 976439



97644 VISERBELLA

pendant light; steel, champagne / fabric, gold
 Hängeleuchte; Stahl, champagner / Textil, gold
 luminaire en suspension; acier, champagne / tissu, doré

H 1100, Ø 530



9 002759 976446



97641 VISERBELLA

ceiling light; steel, champagne / fabric, gold
 Deckenleuchte; Stahl, champagner / Textil, gold
 plafonnier; acier, champagne / tissu, doré

H 110, Ø 380



9 002759 976415





97641



97642



97641 | 97642



97642 VISERBELLA

ceiling light; steel, champagne / fabric, gold
Deckenleuchte; Stahl, champagner / Textil, gold
plafonnier; acier, champagne / tissu, doré

H 195, Ø 470



E27



3x 25W



9 002759 976422





DESIGN
HIGHLIGHT
DETAIL



97645



97647

97645 VISERBELLA

wall light; steel, champagne / fabric, gold
Wandleuchte; Stahl, champagner / Textil, gold
Applique; acier, champagne / tissu, doré

L 145, H 305, A 195



E27

1x 60W



9 002759 976453



97647 VISERBELLA

floor light; steel, champagne / fabric, gold
Stehleuchte; Stahl, champagner / Textil, gold
lampadaire; acier, champagne / tissu, doré

H 1585, Ø 280, Base: Ø 230



E27

1x 60W



9 002759 976477

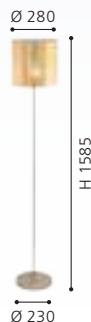

97646 VISERBELLA

table light; steel, champagne / fabric, gold
Tischleuchte; Stahl, champagner / Textil, gold
luminaire de table; acier, champagne / tissu, doré

H 400, Ø 180, Base: Ø 150



E27

1x 60W



9 002759 976460

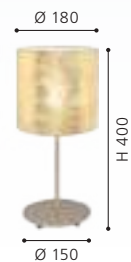



97646



DESIGN
HIGHLIGHT
DETAIL



99272

99273

99273 ESTEPERRA

pendant light; steel, black / fabric, black, gold
Hängeleuchte; Stahl, schwarz / Textil, schwarz, gold
luminaire en suspension; acier, noir / tissu, noir, or

H 1100, Ø 380



99272 ESTEPERRA

ceiling light; steel, black / fabric, black, gold
Deckenleuchte; Stahl, schwarz / Textil, schwarz, gold
plafonnier; acier, noir / tissu, noir, or

H 240, Ø 475

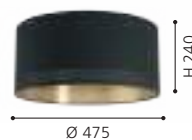

99274 ESTEPERRA

pendant light; steel, black / fabric, black, gold
Hängeleuchte; Stahl, schwarz / Textil, schwarz, gold
luminaire en suspension; acier, noir / tissu, noir, or

H 1100, Ø 530





99274



99279

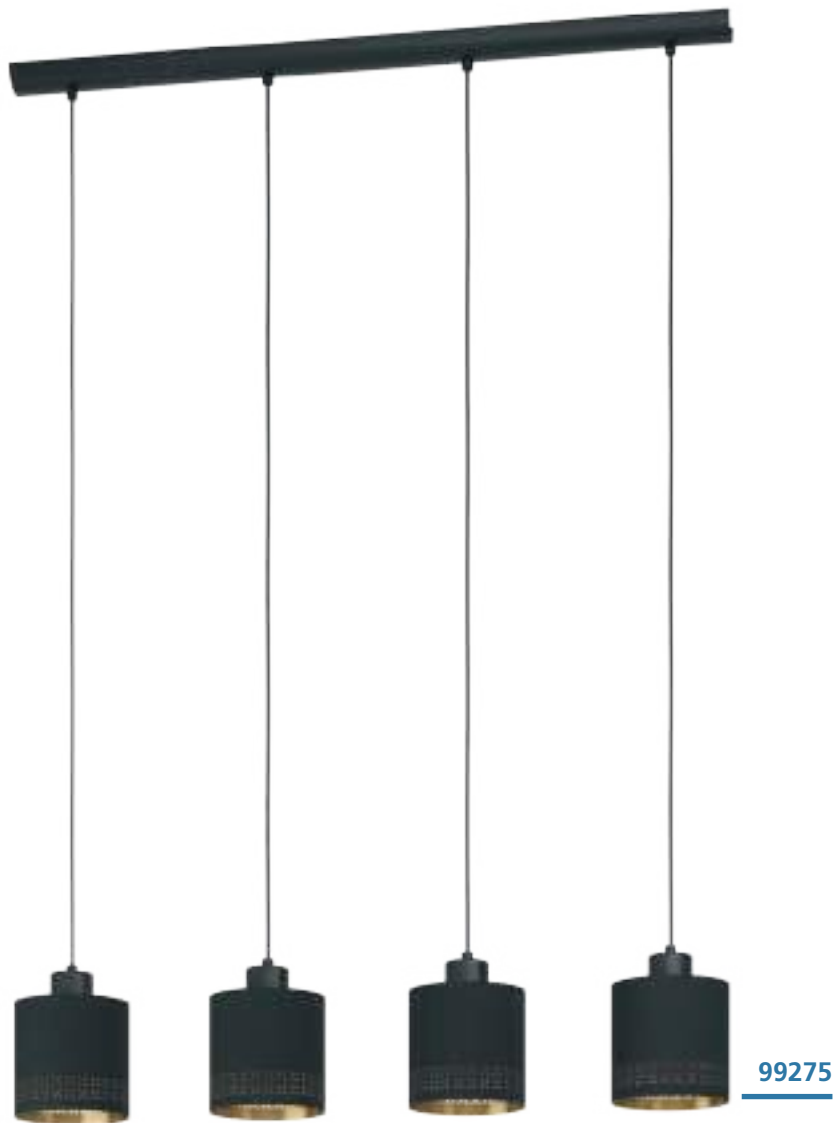

DESIGN
HIGHLIGHT
DETAIL



99279 ESTEPERRA

floor light; steel, black / fabric, black, gold
Stehleuchte; Stahl, schwarz / Textil, schwarz, gold
lampadaire; acier, noir / tissu, noir, or

H 1405, Ø 380, Base: Ø 645



E27 1x 40W



9 002759 992798



99275 ESTEPERRA

pendant light; steel, black / fabric, black, gold
Hängeleuchte; Stahl, schwarz / Textil, schwarz, gold
luminaire en suspension; acier, noir / tissu, noir, or

L 940, B 160, H 1100



E27 4x 28W



9 002759 992750

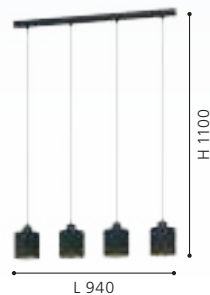



98313



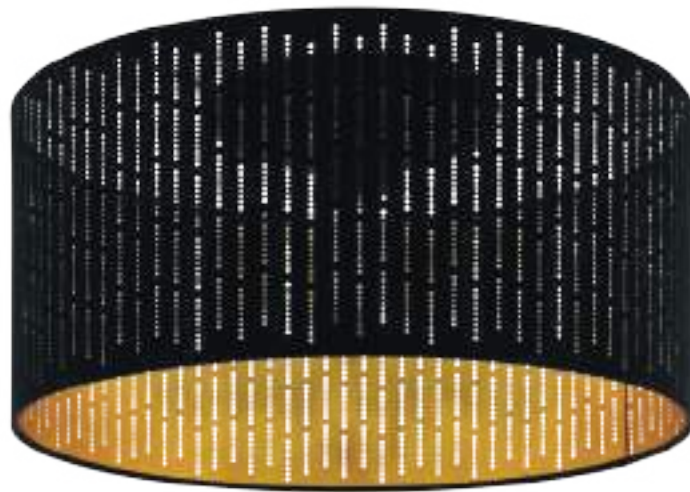

98311



98314



98313 VARILLAS

pendant light; steel, black / fabric with cut-outs, black, gold
 Hängeleuchte; Stahl, schwarz / Textil mit Ausstanzungen, schwarz, gold
 luminaire en suspension; acier, noir / tissu avec découpes, noir, or

H 1100, Ø 530



98311 VARILLAS

ceiling light; steel, black / fabric with cut-outs, black, gold
 Deckenleuchte; Stahl, schwarz / Textil mit Ausstanzungen, schwarz, gold
 plafonnier; acier, noir / tissu avec découpes, noir, or

H 240, Ø 475

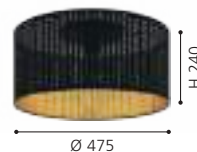

98314 VARILLAS

table light; steel, black / fabric with cut-outs, black, gold
 Tischleuchte; Stahl, schwarz / Textil mit Ausstanzungen, schwarz, gold
 luminaire de table; acier, noir / tissu avec découpes, noir, or

H 255, Ø 120

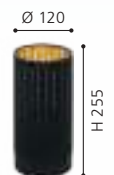



99613

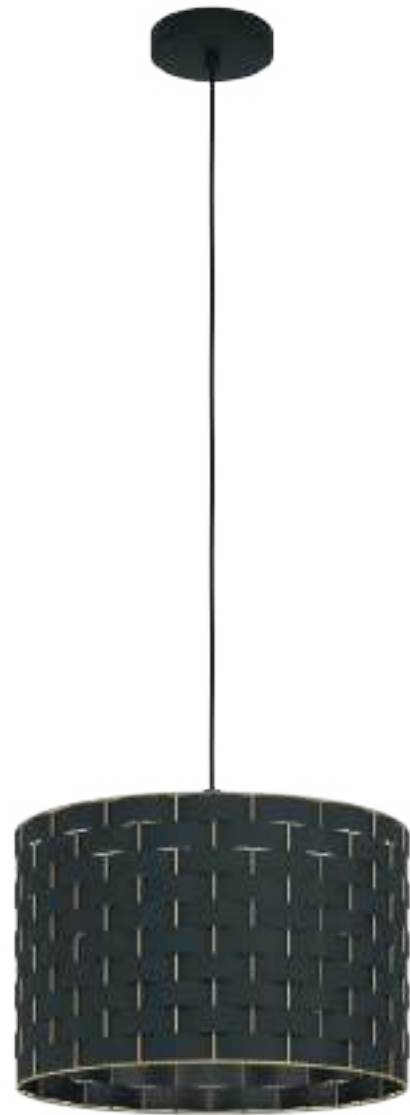

99524

99613 MARASALES

pendant light; steel, black / fabric, black, brass
 Hängeleuchte; Stahl, schwarz / Textil, schwarz, messing
 luminaire en suspension; acier, noir / tissu, noir, laiton

L 780, B 220, H 1100



E27 2x 40W



9 002759 996130

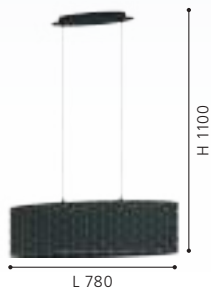

99524 MARASALES

pendant light; steel, black / fabric, black, brass
 Hängeleuchte; Stahl, schwarz / Textil, schwarz, messing
 luminaire en suspension; acier, noir / tissu, noir, laiton

H 1100, Ø 380



E27 1x 40W



9 002759 995249



99525 MARASALES

pendant light; steel, black / fabric, black, brass
 Hängeleuchte; Stahl, schwarz / Textil, schwarz, messing
 luminaire en suspension; acier, noir / tissu, noir, laiton

H 1100, Ø 550



E27 1x 40W



9 002759 995256





99525





99523



99526

99523 MARASALES

ceiling light; steel, black / fabric, black, brass
Deckenleuchte; Stahl, schwarz / Textil, schwarz, messing
plafonnier; acier, noir / tissu, noir, laiton

H 250, Ø 480



E27

1x 40W



9 002759 995232

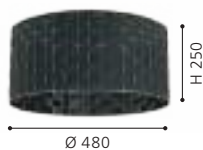

99526 MARASALES

table light; steel, black / fabric, black, brass
Tischleuchte; Stahl, schwarz / Textil, schwarz, messing
luminaire de table; acier, noir / tissu, noir, laiton

H 570, Ø 280



E27

1x 40W



9 002759 995263



99527 MARASALES

floor light; steel, black / fabric, black, brass
Stehleuchte; Stahl, schwarz / Textil, schwarz, messing
lampadaire; acier, noir / tissu, noir, laiton

H 1490, Ø 450, Base: Ø 745



E27

1x 40W



9 002759 995270

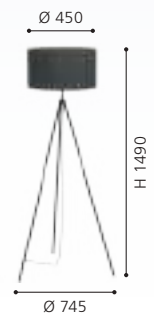



99527



900145



900144



900146

900145 ZARAGOZA

pendant light; steel, black / fabric with decoration, black, gold
 Hängeleuchte; Stahl, schwarz / Textil mit Dekor, schwarz, gold
 luminaire en suspension; acier, noir / tissu avec décor, noir, or

H 1100, Ø 380



E27



1x 40W



9 008606 235384



900144 ZARAGOZA

ceiling light; steel, black / fabric with decoration, black, gold
 Deckenleuchte; Stahl, schwarz / Textil mit Dekor, schwarz, gold
 plafonnier; acier, noir / tissu avec décor, noir, or

H 240, Ø 475



E27



1x 40W



9 008606 235377



900146 ZARAGOZA

pendant light; steel, black / fabric with decoration, black, gold
 Hängeleuchte; Stahl, schwarz / Textil mit Dekor, schwarz, gold
 luminaire en suspension; acier, noir / tissu avec décor, noir, or

H 1100, Ø 530



E27



1x 40W



9 008606 235391





900147

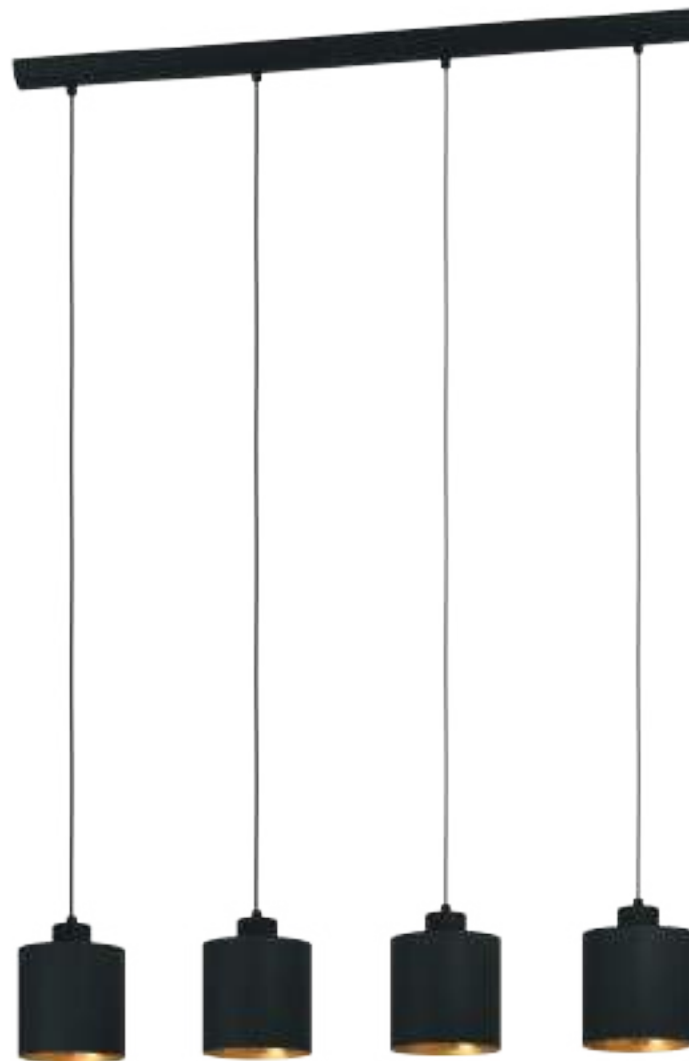

900148

900147 ZARAGOZA

pendant light; steel, black / fabric with decoration, black, gold
 Hängeleuchte; Stahl, schwarz / Textil mit Dekor, schwarz, gold
 luminaire en suspension; acier, noir / tissu avec décor, noir, or

L 780, B 220, H 1100

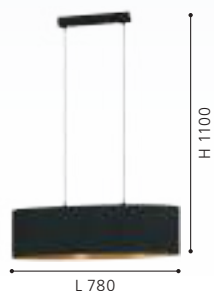

900148 ZARAGOZA

pendant light; steel, black / fabric with decoration, black, gold
 Hängeleuchte; Stahl, schwarz / Textil mit Dekor, schwarz, gold
 luminaire en suspension; acier, noir / tissu avec décor, noir, or

L 925, B 160, H 1100

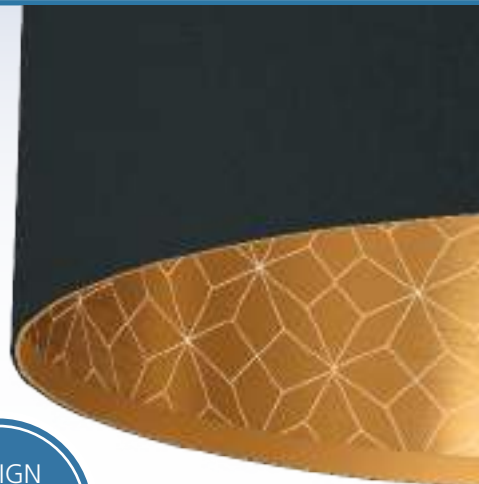



900634

900634 BUCAMARANGA

ceiling light; steel, white / fabric with decoration, white, gold
Deckenleuchte; Stahl, weiss / Textil mit Dekor, weiss, gold
plafonnier; acier, blanc / tissu avec décor, blanc, or

H 240, Ø 475



9 008606 241200



900635 BUCAMARANGA

pendant light; steel, white / fabric with decoration, white, gold
Hängeleuchte; Stahl, weiss / Textil mit Dekor, weiss, gold
luminaire en suspension; acier, blanc / tissu avec décor, blanc, or

H 1100, Ø 530



9 008606 241217





900635





31601



99543

LED



31606

31601 MASERLO

pendant light; steel, satin nickel / fabric, grey, silver
 Hängeleuchte; Stahl, nickel-matt / Textil, grau, silber
 luminaire en suspension; acier, nickel mat / tissu, gris, argent

H 1100, Ø 380



9 002759 316013



Ø 380

H 1100

31606 MASERLO

pendant light; steel, satin nickel / fabric, grey, silver
 Hängeleuchte; Stahl, nickel-matt / Textil, grau, silber
 luminaire en suspension; acier, nickel mat / tissu, gris, argent

H 1100, Ø 530



9 002759 316068



Ø 530

H 1100

99543 MASERLO 2

ceiling light; plastic, steel, white / fabric, grey, silver
 Deckenleuchte; Kunststoff, Stahl, weiss / Textil, grau, silber
 plafonnier; plastique, acier, blanc / tissu, gris, argent

H 90, Ø 380



9 002759 995430



Ø 380

H 90



95173



95173 MASERLO

floor light; steel, satin nickel / fabric, grey, silver
Stehleuchte; Stahl, nickel-matt / Textil, grau, silber
lampadaire; acier, nickel mat / tissu, gris, argent

H 1510, Ø 380, Base: Ø 250



E27



1x 60W



9 002759 951733

Ø 380

H 1510

Ø 250



99042



99043

99042 MASERLO 1

pendant light; steel, black / fabric, black
 Hängeleuchte; Stahl, schwarz / Textil, schwarz
 luminaire en suspension; acier, noir / tissu, noir

H 1100, Ø 380



9 002759 990428



99043 MASERLO 1

pendant light; steel, black / fabric, black
 Hängeleuchte; Stahl, schwarz / Textil, schwarz
 luminaire en suspension; acier, noir / tissu, noir

H 1100, Ø 530

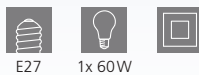

9 002759 990435



99045 MASERLO 1

table light; steel, black / fabric, black
 Tischleuchte; Stahl, schwarz / Textil, schwarz
 luminaire de table; acier, noir / tissu, noir

H 415, Ø 230, Base: Ø 145



9 002759 990459





MASERLO 1



99045

99046 MASERLO 1

floor light; steel, black / fabric, black
Stehleuchte; Stahl, schwarz / Textil, schwarz
lampadaire; acier, noir / tissu, noir

H 1515, Ø 380, Base: Ø 250



E27



1x 40W



9 002759 990466

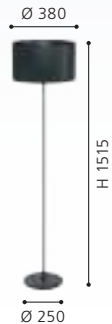

99046



31611



31616



31611 MASERLO

pendant light; steel, satin nickel / fabric, black, gold
Hängeleuchte; Stahl, nickel-matt / Textil, schwarz, gold
luminaire en suspension; acier, nickel mat / tissu, noir, or

L 780, B 220, H 1100

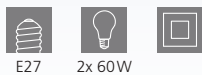

E27 2x 60W

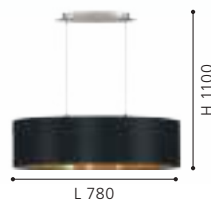

31616 MASERLO

pendant light; steel, satin nickel / fabric, black, gold
Hängeleuchte; Stahl, nickel-matt / Textil, schwarz, gold
luminaire en suspension; acier, nickel mat / tissu, noir, or

L 1000, B 250, H 1100

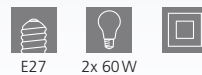

E27 2x 60W

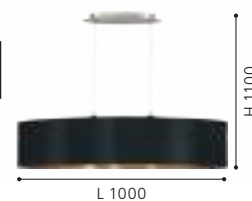



31599



31605

31599 MASERLO

pendant light; steel, satin nickel / fabric, black, gold
 Hängeleuchte; Stahl, nickel-matt / Textil, schwarz, gold
 luminaire en suspension; acier, nickel mat / tissu, noir, or

H 1100, Ø 380

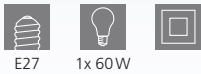

E27 1x 60W



9 002759 315993

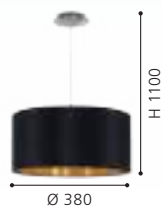

31605 MASERLO

pendant light; steel, satin nickel / fabric, black, gold
 Hängeleuchte; Stahl, nickel-matt / Textil, schwarz, gold
 luminaire en suspension; acier, nickel mat / tissu, noir, or

H 1100, Ø 530



E27 3x 60W



9 002759 316051

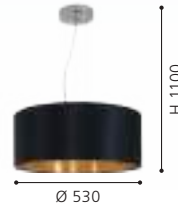



99539

LED



31627

99539 MASERLO 2

ceiling light; plastic, steel, white / fabric, black, gold
Deckenleuchte; Kunststoff, Stahl, weiss / Textil, schwarz, gold
plafonnier; plastique, acier, blanc / tissu, noir, or

H 90, Ø 380



20W



2400lm



9 002759 995393



31627 MASERLO

table light; steel, satin nickel / fabric, black, gold
Tischleuchte; Stahl, nickel-matt / Textil, schwarz, gold
luminaire de table; acier, nickel mat / tissu, noir, or

H 420, Ø 230, Base: Ø 145



E27



1x 60W



9 002759 316273



95169 MASERLO

floor light; steel, satin nickel / fabric, black, gold
Stehleuchte; Stahl, nickel-matt / Textil, schwarz, gold
lampadaire; acier, nickel mat / tissu, noir, or

H 1510, Ø 380, Base: Ø 250



E27



1x 60W



9 002759 951696

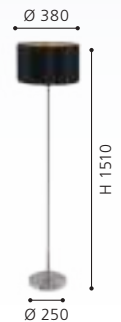



95169



DESIGN
HIGHLIGHT
DETAIL



31618 MASERLO

pendant light; steel, satin nickel / fabric, taupe, gold
Hängeleuchte; Stahl, nickel-matt / Textil, taupe, gold
luminaire en suspension; acier, nickel mat / tissu, taupe, or

L 1000, B 250, H 1100

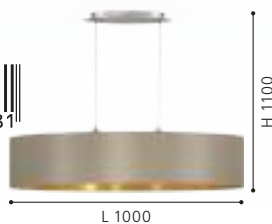

31613 MASERLO

pendant light; steel, satin nickel / fabric, taupe, gold
Hängeleuchte; Stahl, nickel-matt / Textil, taupe, gold
luminaire en suspension; acier, nickel mat / tissu, taupe, or

L 780, B 220, H 1100

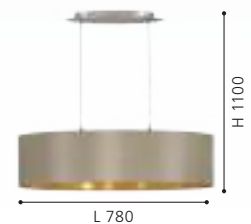



31602

99541

LED



31607

31602 MASERLO

pendant light; steel, satin nickel / fabric, taupe, gold
Hängeleuchte; Stahl, nickel-matt / Textil, taupe, gold
luminaire en suspension; acier, nickel mat / tissu, taupe, or

H 1100, Ø 380



E27 1x 60W



9 002759 316020

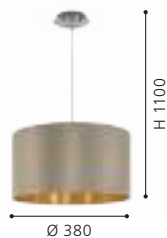

99541 MASERLO 2

ceiling light; plastic, steel, white / fabric, taupe, gold
Deckenleuchte; Kunststoff, Stahl, weiss / Textil, taupe, gold
plafonnier; plastique, acier, blanc / tissu, taupe, or

H 90, Ø 380



LED 20W 2400lm



9 002759 995416

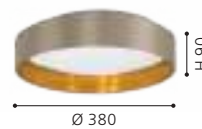

31607 MASERLO

pendant light; steel, satin nickel / fabric, taupe, gold
Hängeleuchte; Stahl, nickel-matt / Textil, taupe, gold
luminaire en suspension; acier, nickel mat / tissu, taupe, or

H 1100, Ø 530



E27 3x 60W



9 002759 316075

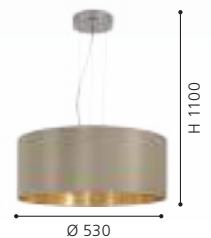



95055



95055

The diffuser on the top ensures harmonious light distribution.

Der Diffusor auf der Oberseite sorgt für eine harmonische Lichtverteilung.

Le diffuseur situé sur le dessus assure une répartition harmonieuse de la lumière.



31629



95171

95055 MASERLO

wall light; steel, satin nickel / fabric, taupe, gold
Wandleuchte; Stahl, nickel-matt / Textil, taupe, gold
Applique; acier, nickel mat / tissu, taupe, or

H 260, Ø 230, A 595



E27

1x 60W



9 002759 950552

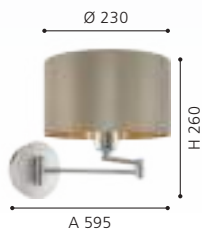

31629 MASERLO

table light; steel, satin nickel / fabric, taupe, gold
Tischleuchte; Stahl, nickel-matt / Textil, taupe, gold
luminaire de table; acier, nickel mat / tissu, taupe, or

H 420, Ø 230, Base: Ø 145



E27

1x 60W



9 002759 316297



95171 MASERLO

floor light; steel, satin nickel / fabric, taupe, gold
Stehleuchte; Stahl, nickel-matt / Textil, taupe, gold
lampadaire; acier, nickel mat / tissu, taupe, or

H 1510, Ø 380, Base: Ø 250



E27

1x 60W



9 002759 951719

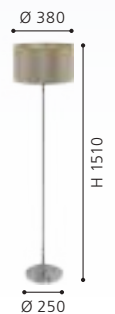



31614



31603



31614 MASERLO

pendant light; steel, satin nickel / fabric, cappuccino, gold
 Hängeleuchte; Stahl, nickel-matt / Textil, cappuccino, gold
 luminaire en suspension; acier, nickel mat / tissu, cappucino, or

L 780, B 220, H 1100

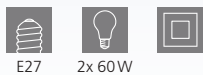

E27 2x 60W

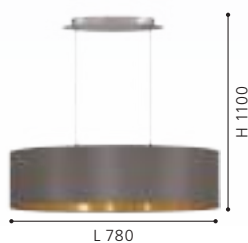

31603 MASERLO

pendant light; steel, satin nickel / fabric, cappuccino, gold
 Hängeleuchte; Stahl, nickel-matt / Textil, cappuccino, gold
 luminaire en suspension; acier, nickel mat / tissu, cappucino, or

H 1100, Ø 380

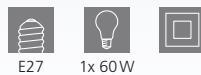

E27 1x 60W





99542

LED



31608

99542 MASERLO 2

ceiling light; plastic, steel, white / fabric, cappuccino, gold
Deckenleuchte; Kunststoff, Stahl, weiss / Textil, cappuccino, gold
plafonnier; plastique, acier, blanc / tissu, cappuccino, or

H 90, Ø 380

LED

warm
WHITE
20W 2400lm

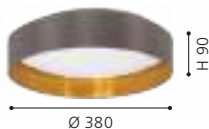

31608 MASERLO

pendant light; steel, satin nickel / fabric, cappuccino, gold
Hängeleuchte; Stahl, nickel-matt / Textil, cappuccino, gold
luminaire en suspension; acier, nickel mat / tissu, cappuccino, or

H 1100, Ø 530



E27



3x 60W



31631 MASERLO

table light; steel, satin nickel / fabric, cappuccino, gold
Tischleuchte; Stahl, nickel-matt / Textil, cappuccino, gold
luminaire de table; acier, nickel mat / tissu, cappuccino, or

H 420, Ø 230, Base: Ø 145



E27



1x 60W





31631

95172 MASERLO

floor light; steel, satin nickel / fabric, cappuccino, gold
Stehleuchte; Stahl, nickel-matt / Textil, cappuccino, gold
lampadaire; acier, nickel mat / tissu, cappuccino, or

H 1510, Ø 380, Base: Ø 250



E27



1x 60W



9 002759 951726



95172

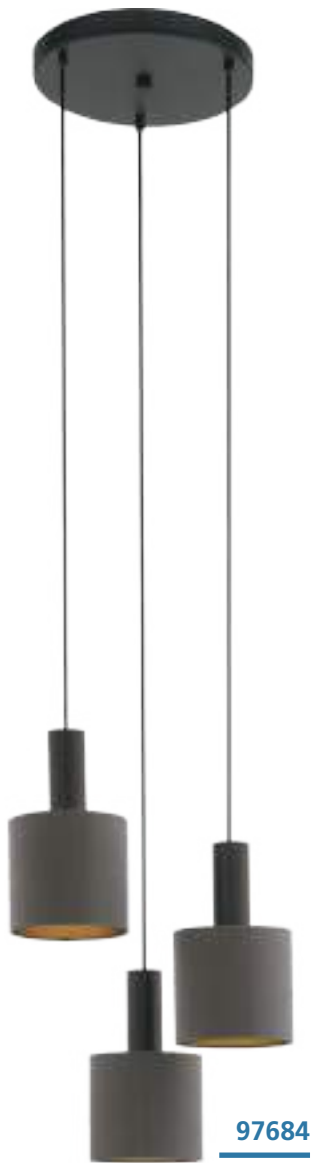

97684

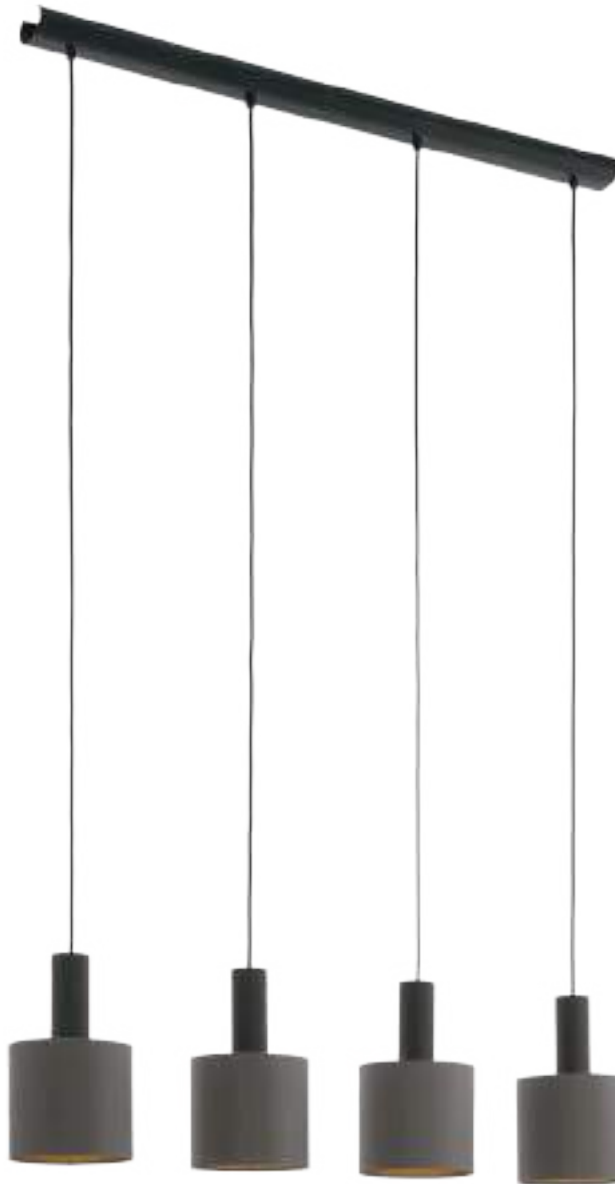

97685

97684 CONCESSA 1

pendant light; steel, dark brown / fabric, cappuccino, gold
 Hängeleuchte; Stahl, dunkelbraun / Textil, cappuccino, gold
 luminaire en suspension; acier, marron foncé / tissu, cappuccino, or

H 1500, Ø 420



9 002759 976842



97685 CONCESSA 1

pendant light; steel, dark brown / fabric, cappuccino, gold
 Hängeleuchte; Stahl, dunkelbraun / Textil, cappuccino, gold
 luminaire en suspension; acier, marron foncé / tissu, cappuccino, or

L 940, B 160, H 1500



9 002759 976859

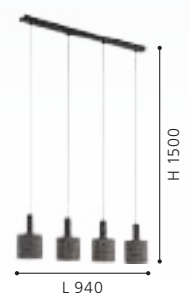



97683



97682

97683 CONCESSA 1

pendant light; steel, dark brown / fabric, cappuccino, gold
 Hängeleuchte; Stahl, dunkelbraun / Textil, cappuccino, gold
 luminaire en suspension; acier, marron foncé / tissu, cappuccino, or

H 1500, Ø 530

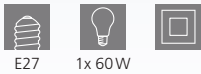

97682 CONCESSA 1

pendant light; steel, dark brown / fabric, cappuccino, gold
 Hängeleuchte; Stahl, dunkelbraun / Textil, cappuccino, gold
 luminaire en suspension; acier, marron foncé / tissu, cappuccino, or

H 1500, Ø 380

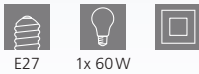

DESIGN
HIGHLIGHT
DETAIL



99445



99446



99445 ALBARIZA

pendant light; steel, wood, black, brown / fabric, cappuccino, gold

Hängeleuchte; Stahl, Holz, schwarz, braun / Textil, cappuccino, gold

luminaire en suspension; acier, bois, noir, marron / tissu, cappuccino, or

H 1100, Ø 160



E27

1x 40W



9 002759 994457

99446 ALBARIZA

pendant light; steel, wood, black, brown / fabric, cappuccino, gold

Hängeleuchte; Stahl, Holz, schwarz, braun / Textil, cappuccino, gold

luminaire en suspension; acier, bois, noir, marron / tissu, cappuccino, or

L 895, B 160, H 1100



E27

3x 40W



9 002759 994464

99447 ALBARIZA

pendant light; steel, wood, black, brown / fabric, cappuccino, gold

Hängeleuchte; Stahl, Holz, schwarz, braun / Textil, cappuccino, gold

luminaire en suspension; acier, bois, noir, marron / tissu, cappuccino, or

H 1500, Ø 700



E27

5x 40W



9 002759 994471



99447





900861



900861

900861 FENIGLIA

table light; steel, black / fabric, linen, natural
Tischleuchte; Stahl, schwarz / Textil, Leinen, natur
luminaire de table; acier, noir / tissu, lin, nature

H 255, Ø 120, Base: Ø 120



E27



1x 40W



9 008606 274420





900859



900858



EGLO
RECOMMENDS
110042

900858



EGLO
RECOMMENDS
110038

900859 | 900862



900862

900859 FENIGLIA

pendant light; steel, black / fabric, linen, natural
Hängeleuchte; Stahl, schwarz / Textil, Leinen, natur
luminaire en suspension; acier, noir / tissu, lin, nature

H 1100, Ø 380



E27 1x 40W



9 008606 274413



900858 FENIGLIA

ceiling light; steel, black / fabric, linen, natural
Deckenleuchte; Stahl, schwarz / Textil, Leinen, natur
plafonnier; acier, noir / tissu, lin, nature

H 240, Ø 475



E27 1x 40W



9 008606 274406



900862 FENIGLIA

floor light; steel, black / fabric, linen, natural
Stehleuchte; Stahl, schwarz / Textil, Leinen, natur
lampadaire; acier, noir / tissu, lin, nature

H 1510, Ø 380, Base: Ø 250



E27 1x 40W



9 008606 274437

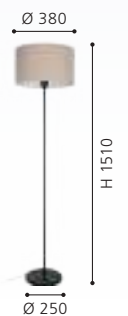



99487 ALMEIDA 2

pendant light; steel, brushed brass / fabric, cappuccino, brass
 Hängeleuchte; Stahl, messing-gebürstet / Textil, cappuccino, messing
 luminaire en suspension; acier, laiton brossé / tissu, cappuccino, laiton

L 1200, B 155, H 1100



E14 5x 40W



9 002759 994877

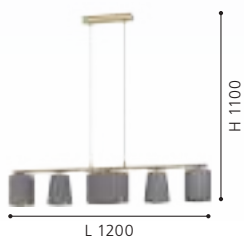

99486 ALMEIDA 2

ceiling light; steel, brushed brass / fabric, cappuccino, brass
 Deckenleuchte; Stahl, messing-gebürstet / Textil, cappuccino, messing
 plafonnier; acier, laiton brossé / tissu, cappuccino, laiton

L 810, B 155, H 280



E14 3x 40W



9 002759 994860

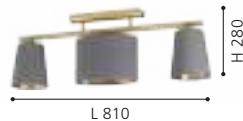

99612 ALMEIDA 2

floor light; steel, brushed brass / fabric, cappuccino, brass
 Stehleuchte; Stahl, messing-gebürstet / Textil, cappuccino, messing
 lampadaire; acier, laiton brossé / tissu, cappuccino, laiton

H 1670, Ø 320, Base: Ø 300

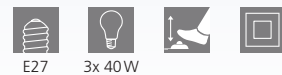

E27 3x 40W



9 002759 996123





99612

99611 ALMEIDA 2

table light; steel, brushed brass / fabric, cappuccino, brass
 Tischleuchte; Stahl, messing-gebürstet / Textil, cappuccino, messing
 luminaire de table; acier, laiton brossé / tissu, cappuccino, laiton

H 605, Ø 260, Base: Ø 200



E27



2x 40W



9 002759 996116

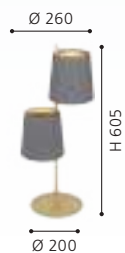

99611

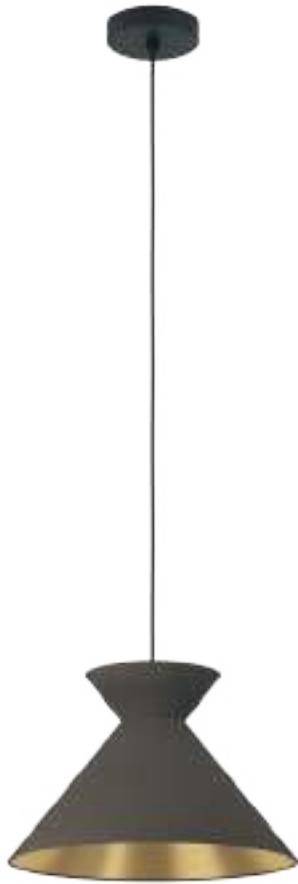

900347



900348



DESIGN
HIGHLIGHT
DETAIL

900347 NASTASIA

pendant light; steel, black / fabric, cappuccino, brass
Hängeleuchte; Stahl, schwarz / Textil, cappuccino, messing
luminaire en suspension; acier, noir / tissu, cappuccino, laiton

H 1100, Ø 380



9 008606 238859



900348 NASTASIA

pendant light; steel, black / fabric, cappuccino, brass
Hängeleuchte; Stahl, schwarz / Textil, cappuccino, messing
luminaire en suspension; acier, noir / tissu, cappuccino, laiton

L 1000, B 240, H 1100



9 008606 238866





900376



900378



900377

900376 AGLIENTINA

pendant light; steel, brushed brass / fabric, white, brass
Hängeleuchte; Stahl, messing-gebürstet / Textil, weiss, messing
luminaire en suspension; acier, laiton brossé / tissu, blanc, laiton

H 1100, Ø 200

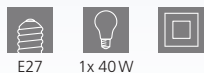

E27 1x 40W



9 008606 243587



900378 AGLIENTINA

floor light; steel, brushed brass / fabric, white, brass
Stehleuchte; Stahl, messing-gebürstet / Textil, weiss, messing
lampadaire; acier, laiton brossé / tissu, blanc, laiton

H 1700, Ø 200, Base: Ø 250



E27 1x 40W



9 008606 243600



900377 AGLIENTINA

pendant light; steel, brushed brass / fabric, white, brass
Hängeleuchte; Stahl, messing-gebürstet / Textil, weiss, messing
luminaire en suspension; acier, laiton brossé / tissu, blanc, laiton

L 900, B 200, H 1100



E27 3x 40W



9 008606 243594





98587 ALMEIDA 1

pendant light; steel, black / fabric, grey, white
 Hängeleuchte; Stahl, schwarz / Textil, grau, weiss
 luminaire en suspension; acier, noir / tissu, gris, blanc

L 860, B 255, H 1100



98588 ALMEIDA 1

pendant light; steel, black / fabric, black, grey, white
 Hängeleuchte; Stahl, schwarz / Textil, schwarz, grau, weiss
 luminaire en suspension; acier, noir / tissu, noir, gris, blanc

L 1200, B 255, H 1100





95192



95194



94995

95192 ALMEIDA

ceiling light; steel, black / fabric, anthracite, white, brown
Deckenleuchte; Stahl, schwarz / Textil, anthrazit, weiss, braun
plafonnier; acier, noir / tissu, anthracite, blanc, marron

H 350, Ø 590

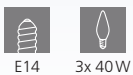

E14 3x 40W



9 002759 951924

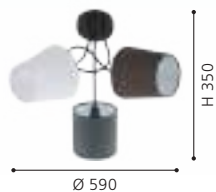

95194 ALMEIDA

table light; steel, black / fabric, white, anthracite
Tischleuchte; Stahl, schwarz / Textil, weiss, anthrazit
luminaire de table; acier, noir / tissu, blanc, anthracite

L 380, B 185, H 475, Base: Ø 155



E14 2x 40W



9 002759 951948



94995 MARONDA

floor light; steel, black / fabric, anthracite, white, brown
Stehleuchte; Stahl, schwarz / Textil, anthrazit, weiss, braun
lampadaire; acier, noir / tissu, anthracite, blanc, marron

L 275, B 35, H 1520, Base: Ø 230



E14 3x 40W



9 002759 949952

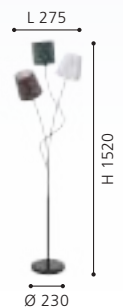

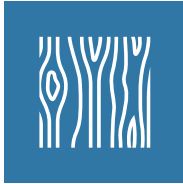

LIGHTING FAMILIES / WOOD LUMINAIRES

LEUCHTENFAMILIEN / HOLZLEUCHTEN
FAMILLES DE LUMINAIRES / LUMINAIRES À BOIS



EN **SIMPLE CLASSINESS**

The wood luminaires with their unusual designs are perfectly trendy and bring cosiness to every home. Our range of wood luminaires offers a great selection of various shapes, sizes and colours. It contains anything from suspended to table luminaires.

DE **SCHLICHTE ELEGANZ**

Die Holzleuchten mit ihrem außergewöhnlichen Design sind voll im Trend und sorgen für Gemütlichkeit in jedem Zuhause. Unser Sortiment an Holzleuchten bietet eine große Auswahl an verschiedenen Formen, Größen sowie Farben und reicht von der Hänge- bis hin zur Tischleuchte.

FR **ÉLÉGANCE SIMPLE**

Les luminaires en bois avec leur design extraordinaire sont très tendance et assurent un confort dans chaque maison. Notre gamme de luminaires en bois offre un grand choix de formes, de tailles et de couleurs différentes et s'étend des luminaires en suspension jusqu'aux luminaires de table.





OVERVIEW

LIGHTING FAMILIES / WOOD LUMINAIRES
LEUCHTENFAMILIEN / HOLZLEUCHTEN
FAMILLES DE LUMINAIRES / LUMINAIRES À BOIS



This product is available in different colors and shapes. / Dieser Artikel ist in unterschiedlichen Farben und Formen verfügbar. /
Cet article est disponible en différentes couleurs et formes.

WOOD MATERIALS

HOLZ MATERIALIEN / MATÉRIAUX EN BOIS

LAMELLA SHADES / LAMELLENSCHIRME / OMBRES À LAMELLES



wood, white
Holz, weiß
bois, blanc



wood, brown
Holz, braun
bois, marron



wood, maple
Holz, ahorn
bois, érable



wood, maple
Holz, ahorn
bois, érable



wood, brown
Holz, braun
bois, marron



wood, black
Holz, schwarz
bois, noir



wood, grey
Holz, grau
bois, gris



wood, nut
Holz, nuss
bois, noix

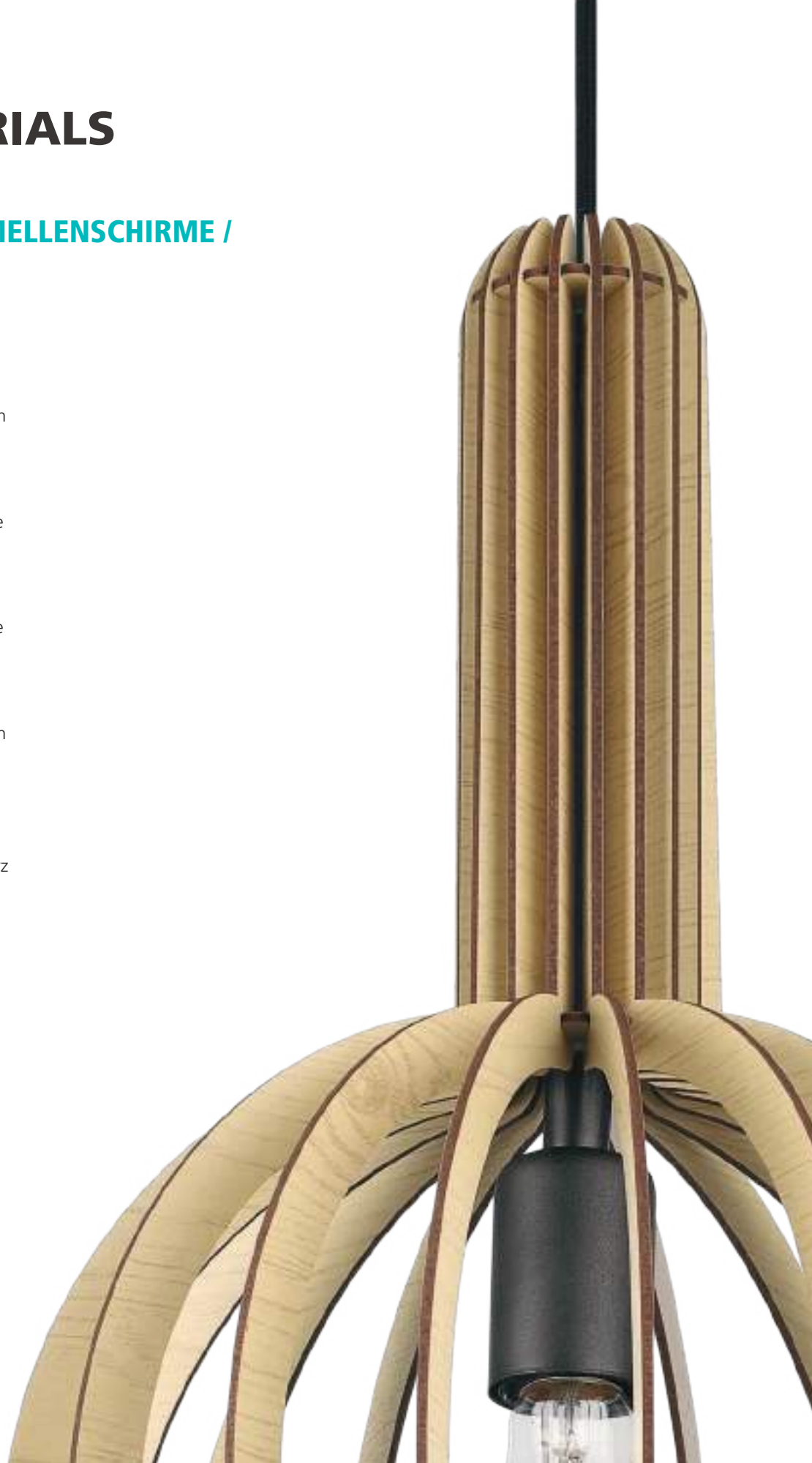

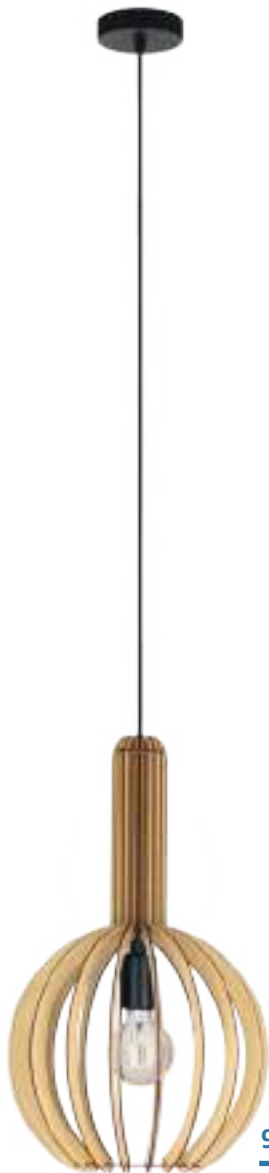

900151



900152



900153

900151 VELASCO

pendant light; steel, black / wood, maple
 Hängeleuchte; Stahl, schwarz / Holz, ahorn
 luminaire en suspension; acier, noir / bois, érable

H 1100, Ø 310

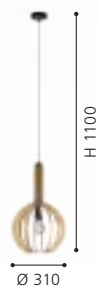

900152 VELASCO

pendant light; steel, black / wood, maple
 Hängeleuchte; Stahl, schwarz / Holz, ahorn
 luminaire en suspension; acier, noir / bois, érable

H 1100, Ø 380



900153 VELASCO

pendant light; steel, black / wood, black
 Hängeleuchte; Stahl, schwarz / Holz, schwarz
 luminaire en suspension; acier, noir / bois, noir

H 1100, Ø 310

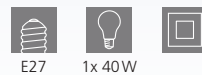



900154

900154 VELASCO

pendant light; steel, black / wood, black
Hängeleuchte; Stahl, schwarz / Holz, schwarz
luminaire en suspension; acier, noir / bois, noir

H 1100, Ø 380



E27



1x 40W



9 008606 224074

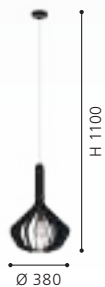



900503



900502

900503 BAJAZZARA

pendant light; steel, black / wood, grey
 Hängeleuchte; Stahl, schwarz / Holz, grau
 luminaire en suspension; acier, noir / bois, gris

L 890, B 190, H 1100



900502 BAJAZZARA

pendant light; steel, black / wood, grey
 Hängeleuchte; Stahl, schwarz / Holz, grau
 luminaire en suspension; acier, noir / bois, gris

H 1100, Ø 260





900505



900504

900505 BAJAZZARA

pendant light; steel, black / wood, black
 Hängeleuchte; Stahl, schwarz / Holz, schwarz
 luminaire en suspension; acier, noir / bois, noir

L 890, B 190, H 1100

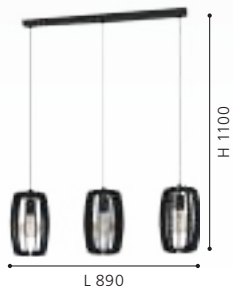

900504 BAJAZZARA

pendant light; steel, black / wood, black
 Hängeleuchte; Stahl, schwarz / Holz, schwarz
 luminaire en suspension; acier, noir / bois, noir

H 1100, Ø 260

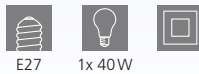



900739



SEGOVIA

Due to the arrangement of the superimposed rings, glare from the light sources is prevented.

Aufgrund der Anordnung der übereinander liegenden Ringe wird das Blenden durch die Leuchtmittel verhindert.

Grâce à la disposition des anneaux superposés, l'éblouissement par les lampes est évité.

900739 SEGOVIA

spot; steel, black / wood, black
Spot; Stahl, schwarz / Holz, schwarz
spot; acier, noir / bois, noir

L 130, H 195, A 175



E27



1x 40W

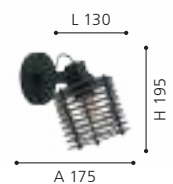



900741



900742



900738



900739 | 900741 | 900742



900738

900741 SEGOVIA

spot; steel, black / wood, black
Spot; Stahl, schwarz / Holz, schwarz
spot; acier, noir / bois, noir

L 335, H 185, A 175



E27 2x 40W



9 008606 267156



L 335

H 185

900742 SEGOVIA

spot; steel, black / wood, black
Spot; Stahl, schwarz / Holz, schwarz
spot; acier, noir / bois, noir

L 575, H 185, A 175



E27 3x 40W



9 008606 267163



L 575

H 185

900738 SEGOVIA

pendant light; steel, black / wood, black
Hängeleuchte; Stahl, schwarz / Holz, schwarz
luminaire en suspension; acier, noir / bois, noir

L 880, B 180, H 1100



E27 3x 40W



9 008606 267132

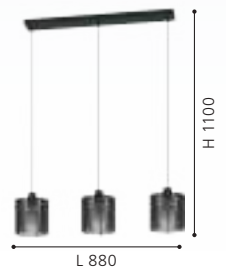

L 880

H 1100



900831

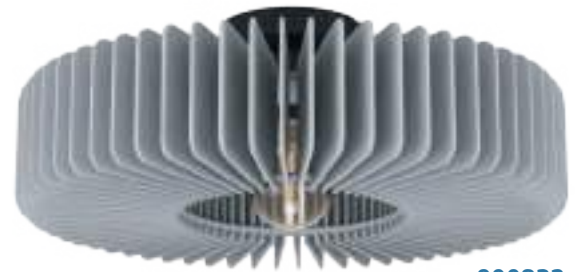

900832



900831 PALOMBAIA

ceiling light; steel, black / wood, black
Deckenleuchte; Stahl, schwarz / Holz, schwarz
plafonnier; acier, noir / bois, noir

H 175, Ø 500



E27



1x 40W



9 008606 274024



900832 PALOMBAIA

ceiling light; steel, black / wood, grey
Deckenleuchte; Stahl, schwarz / Holz, grau
plafonnier; acier, noir / bois, gris

H 175, Ø 500



E27



1x 40W



9 008606 274031



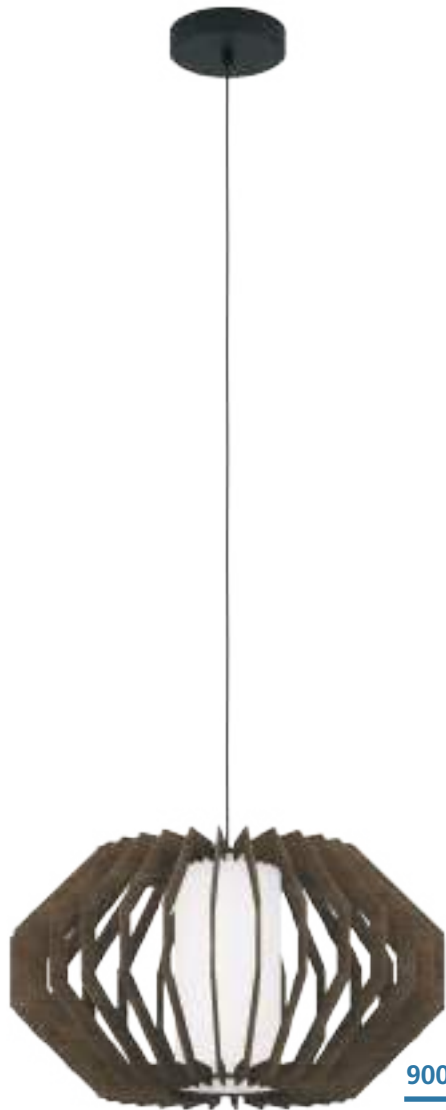

900386



900385

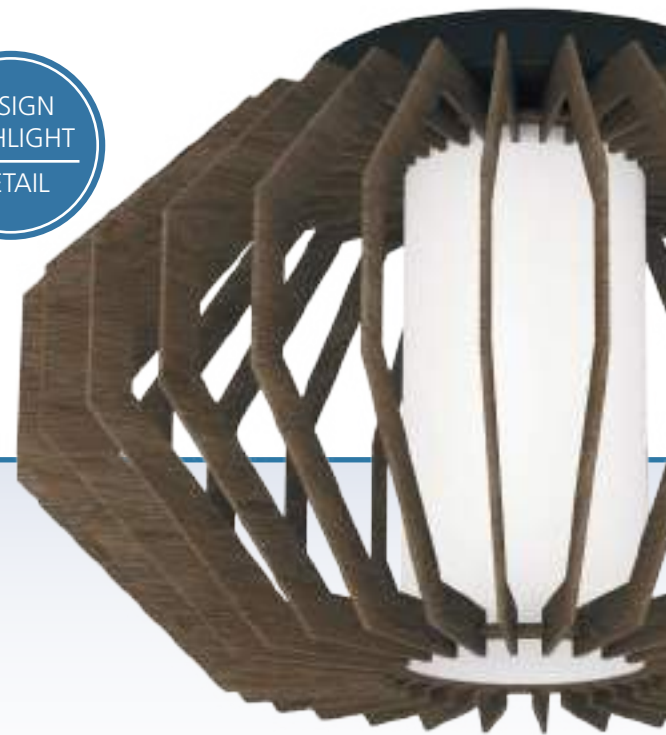

900386 RUSTICARIA

pendant light; steel, black / wood, glass, brown, white
Hängeleuchte; Stahl, schwarz / Holz, Glas, braun, weiss
luminaire en suspension; acier, noir / bois, verre, marron, blanc

H 1100, Ø 450



E27 1x 40W



900385 RUSTICARIA

ceiling light; steel, black / wood, glass, brown, white
Deckenleuchte; Stahl, schwarz / Holz, Glas, braun, weiss
plafonnier; acier, noir / bois, verre, marron, blanc

H 275, Ø 450



E27 1x 40W

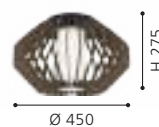



900904

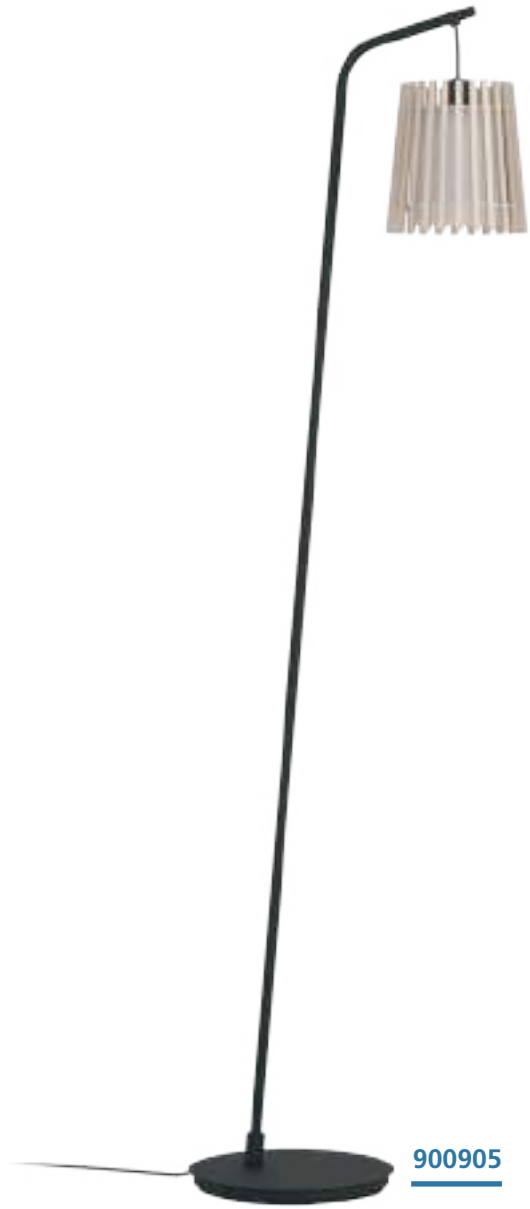

900905

900904 FATTORIA

table light; steel, black / wood, fabric, brown, white
 Tischleuchte; Stahl, schwarz / Holz, Textil, braun, weiss
 luminaire de table; acier, noir / bois, tissu, marron, blanc

H 450, Ø 200, Base: Ø 180

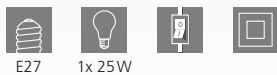

900905 FATTORIA

floor light; steel, black / wood, fabric, brown, white
 Stehleuchte; Stahl, schwarz / Holz, Textil, braun, weiss
 lampadaire; acier, noir / bois, tissu, marron, blanc

L 495, B 200, H 1700, Base: Ø 300

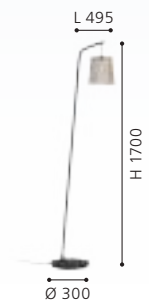
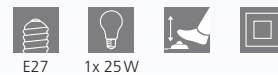

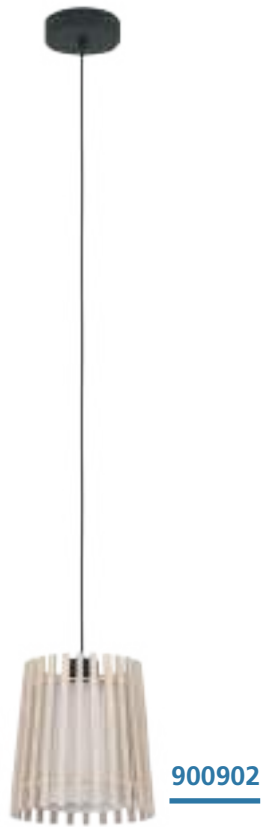

900902



900901



900901



900903



900905 | 900902



900903 | 900904

900902 FATTORIA

pendant light; steel, black / wood, fabric, brown, white
Hängeleuchte; Stahl, schwarz / Holz, Textil, braun, weiss
luminaire en suspension; acier, noir / bois, tissu, marron, blanc

H 1100, Ø 200



E27 1x 25W



9 008606 274727



900903 FATTORIA

pendant light; steel, black / wood, fabric, brown, white
Hängeleuchte; Stahl, schwarz / Holz, Textil, braun, weiss
luminaire en suspension; acier, noir / bois, tissu, marron, blanc

L 900, B 200, H 1100



E27 3x 25W



9 008606 274734



900901 FATTORIA

ceiling light; steel, black / wood, fabric, brown, white
Deckenleuchte; Stahl, schwarz / Holz, Textil, braun, weiss
plafonnier; acier, noir / bois, tissu, marron, blanc

H 240, Ø 380

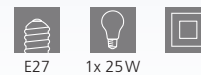

E27 1x 25W



9 008606 274710

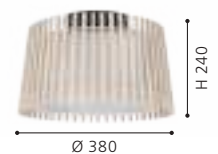



900847



95597



95602

900847 MATTANZA

pendant light; steel, black / wood, grey
Hängeleuchte; Stahl, schwarz / Holz, grau
luminaire en suspension; acier, noir / bois, gris

H 2465, Ø 495



95597 STELLATO 1

ceiling light; steel, satin nickel / wood, glass, maple, white
Deckenleuchte; Stahl, nickel-matt / Holz, Glas, ahorn, weiss
plafonnier; acier, nickel mat / bois, verre, érable, blanc

H 275, Ø 400

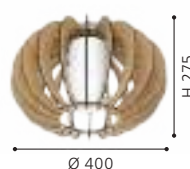

95602 STELLATO 1

wall light; steel, white / wood, glass, maple, white
Wandleuchte; Stahl, weiss / Holz, Glas, ahorn, weiss
Applique; acier, blanc / bois, verre, érable, blanc

L 285, H 250, A 140

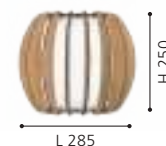



EGLO
RECOMMENDS
110033

STELLATO 1
STELLATO 2

95598 STELLATO 1

pendant light; steel, satin nickel / wood, glass, maple, white
Hängeleuchte; Stahl, nickel-matt / Holz, Glas, ahorn, weiss
luminaire en suspension; acier, nickel mat / bois, verre, érable, blanc

H 1300, Ø 400

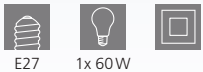

95591 STELLATO 3

pendant light; steel, satin nickel / wood, glass, brown, white
Hängeleuchte; Stahl, nickel-matt / Holz, Glas, braun, weiss
luminaire en suspension; acier, nickel mat / bois, verre, marron, blanc

H 1300, Ø 400

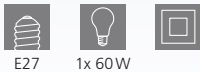

95606 STELLATO 2

pendant light; steel, white / wood, glass, white
Hängeleuchte; Stahl, weiss / Holz, Glas, weiss
luminaire en suspension; acier, blanc / bois, verre, blanc

H 1300, Ø 400

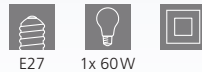



96211



96257

96211 TINDORI

pendant light; steel, satin nickel / wood, glass, white
 Hängeleuchte; Stahl, nickel-matt / Holz, Glas, weiss
 luminaire en suspension; acier, nickel mat / bois, verre, blanc

H 1500, Ø 500



E27



1x 60W



9 002759 962111



96257 TINDORI

pendant light; steel, satin nickel / wood, white
 Hängeleuchte; Stahl, nickel-matt / Holz, weiss
 luminaire en suspension; acier, nickel mat / bois, blanc

H 1300, Ø 380



E27



1x 60W



9 002759 962579





96258



96214



96211 | 96214

96258 TINDORI

pendant light; steel, satin nickel / wood, maple
Hängeleuchte; Stahl, nickel-matt / Holz, ahorn
luminaire en suspension; acier, nickel mat / bois, érable

H 1300, Ø 380

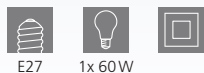

E27 1x 60W



9 002759 962586



96214 TINDORI

pendant light; steel, satin nickel / wood, glass, maple, white
Hängeleuchte; Stahl, nickel-matt / Holz, Glas, ahorn, weiss
luminaire en suspension; acier, nickel mat / bois, verre, érable, blanc

H 1500, Ø 500



E27 1x 60W



9 002759 962142



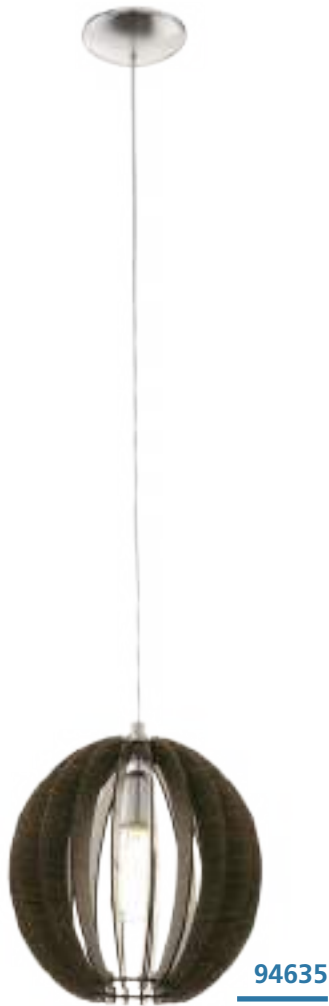

94635



94636



95261

94635 COSSANO

pendant light; steel, satin nickel / wood, brown
 Hängeleuchte; Stahl, nickel-matt / Holz, braun
 luminaire en suspension; acier, nickel mat / bois, marron

H 1300, Ø 300



E27 1x 60W



9 002759 946357



94636 COSSANO

pendant light; steel, satin nickel / wood, brown
 Hängeleuchte; Stahl, nickel-matt / Holz, braun
 luminaire en suspension; acier, nickel mat / bois, marron

H 1500, Ø 500

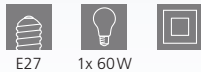

E27 1x 60W



9 002759 946364



95261 COSSANO 2

pendant light; steel, satin nickel / wood, dark brown
 Hängeleuchte; Stahl, nickel-matt / Holz, dunkelbraun
 luminaire en suspension; acier, nickel mat / bois, marron foncé

H 1500, Ø 500



E27 1x 60W



9 002759 952617



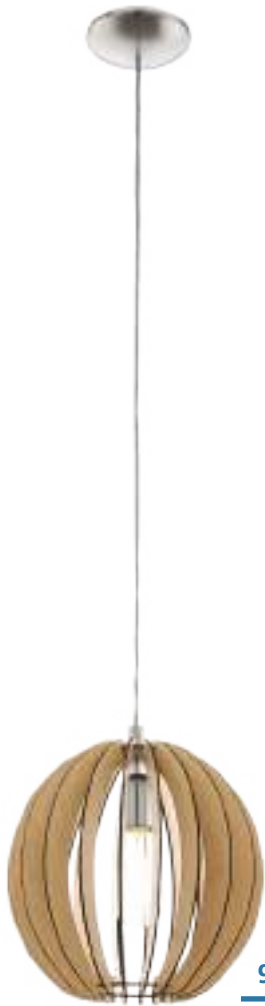

94764



94765

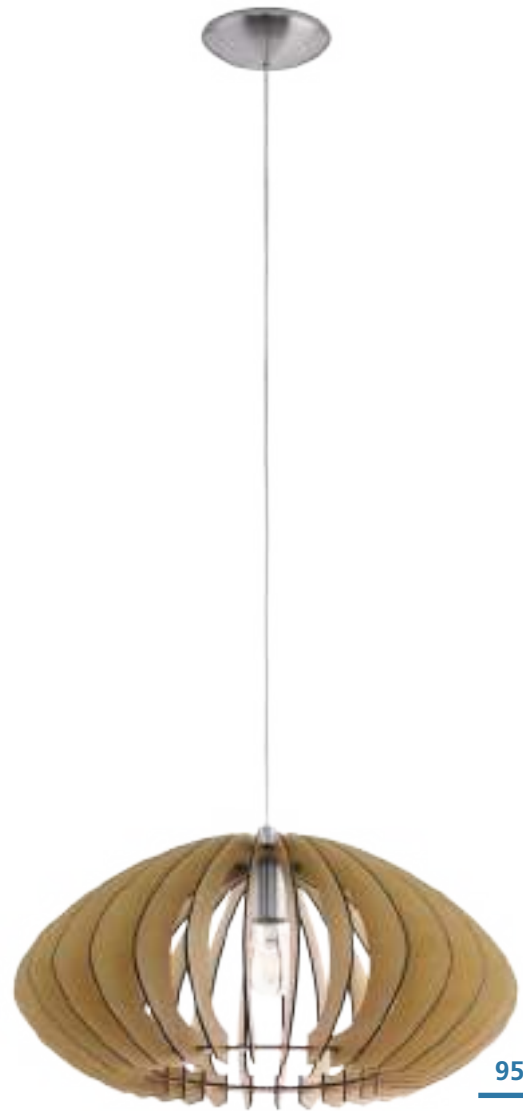

95257

94764 COSSANO

pendant light; steel, satin nickel / wood, maple
Hängeleuchte; Stahl, nickel-matt / Holz, ahorn
luminaire en suspension; acier, nickel mat / bois, érable

H 1300, Ø 300

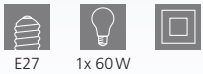

E27 1x 60W



9 002759 947644



94765 COSSANO

pendant light; steel, satin nickel / wood, maple
Hängeleuchte; Stahl, nickel-matt / Holz, ahorn
luminaire en suspension; acier, nickel mat / bois, érable

H 1500, Ø 500

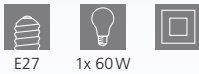

E27 1x 60W



9 002759 947651



95257 COSSANO 2

pendant light; steel, satin nickel / wood, maple
Hängeleuchte; Stahl, nickel-matt / Holz, ahorn
luminaire en suspension; acier, nickel mat / bois, érable

H 1500, Ø 500



E27 1x 60W



9 002759 952570





96194



96195



96193

96194 SENDERO

pendant light; steel, satin nickel / wood, maple
Hängeleuchte; Stahl, nickel-matt / Holz, ahorn
luminaire en suspension; acier, nickel mat / bois, érable

L 775, B 250, H 1300



E27



2x 60W



9 002759 961947



L 775

H 1300

96193 SENDERO

pendant light; steel, satin nickel / wood, maple
Hängeleuchte; Stahl, nickel-matt / Holz, ahorn
luminaire en suspension; acier, nickel mat / bois, érable

H 1300, Ø 450



E27



1x 60W



9 002759 961930



Ø 450

H 1300

96195 SENDERO

wall light; steel, white / wood, maple
Wandleuchte; Stahl, weiss / Holz, ahorn
applique; acier, blanc / bois, érable

L 240, H 220, A 120



E27



1x 60W



9 002759 961954



A 120

H 220



96199



96201

96199 SENDERO

pendant light; steel, satin nickel / wood, brown
 Hängeleuchte; Stahl, nickel-matt / Holz, braun
 luminaire en suspension; acier, nickel mat / bois, marron

H 1300, Ø 450



E27 1x 60W



96201 SENDERO

pendant light; steel, satin nickel / wood, brown
 Hängeleuchte; Stahl, nickel-matt / Holz, braun
 luminaire en suspension; acier, nickel mat / bois, marron

L 775, B 250, H 1300

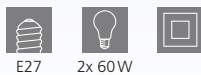

E27 2x 60W





LIGHTING FAMILIES / ESSENTIAL LUMINAIRES

LEUCHTENFAMILIEN / STANDARD LEUCHTEN
FAMILLES DE LUMINAIRES / LUMINAIRES ESSENTIEL

EN FAMILY MEETING

This range combines ceiling, wall, suspended, floor and table luminaires. Give your rooms a consistent and stylish all-round illumination.

DE FAMILIENTREFFEN

Dieses Sortiment vereint sowohl Decken-, Wand- und Hängeleuchten als auch Tisch- und Stehleuchten. Verleihen Sie Ihren Räumlichkeiten eine einheitliche und stilvolle Rundumbeleuchtung.

FR RENCONTRE FAMILIALE

Cette gamme réunit aussi bien des plafonniers, des éclairages muraux, des éclairages suspendus que des lampes de table et des lampadaires. Donnez à vos pièces un éclairage d'ensemble unifié et riche en style.































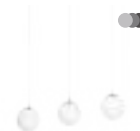















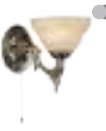













OVERVIEW

LIGHTING FAMILIES / ESSENTIAL LUMINAIRS
LEUCHTENFAMILIEN / STANDARD LEUCHTEN
FAMILLES DE LUMINAIRES / LUMINAIRES ESSENTIEL

 TURALDO 232	 LIBERTAD 234, 236	 LIBERTAD 1 235	 CAMACHO 238-239	 BOYAL 240-243	 PANAGRIA 244-245	 CANTERRAS 246-247	 ABREOSA 248
 ALMUDAINA 250-251	 CASIBARE 252-253	 CREMELLA 254-255	 ROMAZZINA 256-259	 VENEZUELA 260-261	 ESCANDIDOS 262-263	 LURONE 264-265	 ESCANDELL 266-267
 NARICES 1 268	 NARICES 268-269	 BARBOTTO 270-273	 ERSEKA 274-275	 MANZANARES 276-277	 RONDO 278-280	 RONDO 3 280	 OPTICA 282-284
 GOROSIBA 1 286	 GOROSIBA 286-287	 PINTO TEXTIL 1 288	 PINTO TEXTIL 289	 PINTO NERO 290	 PINTO GOLD 292-293	 PINTO 294-295	 TROY 3 296-297
 RIVATO 298	 BAYMAN 299	 VINOVO 300	 MURCIA 300-301	 SAVOY 302-303	 MARBELLA 304-305	 ERVIDEL 306-307	 CLAVELLINA 308-309
 ISIDRO 310-311	 CARANACOA 312-313	 VALLEROSA 314-315	 CODRIALES 316-317	 GIANELLA 318-319	 SIBERIA 320-321	 LEJIAS 322-323	 LASANA 1 324, 329
 LASANA 2 324-325	 LASANA 3 326-327	 LASANA 328	 TARANDELL 329	 RONCADE 1 330	 SELVINA 1 330	 RONCADE 331, 334	 SELVINA 331-332, 335



This product is available in different colors and shapes. / Dieser Artikel ist in unterschiedlichen Farben und Formen verfügbar. / Cet article est disponible en différentes couleurs et formes.



VALMORA
332-333



NEVADO
333



PALOZZA 1
334



PALOZZA
335





DESIGN
HIGHLIGHT
DETAIL



99077



99079

99077 TURALDO

ceiling light; wood, brown
Deckenleuchte; Holz, braun
plafonnier; bois, marron

H 80, Ø 70

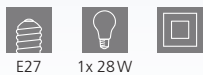

E27 1x 28W



9 002759 990770

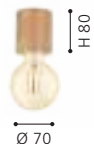

99079 TURALDO

table light; wood, brown
Tischleuchte; Holz, braun
luminaire de table; bois, marron

H 100, Ø 85



E27 1x 28W



9 002759 990794

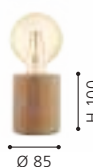

99078 TURALDO

pendant light; wood, steel, brown, black
Hängeleuchte; Holz, Stahl, braun, schwarz
luminaire en suspension; bois, acier, marron, noir

H 1100, Ø 105



E27 1x 28W



9 002759 990787

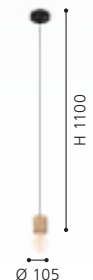



99078

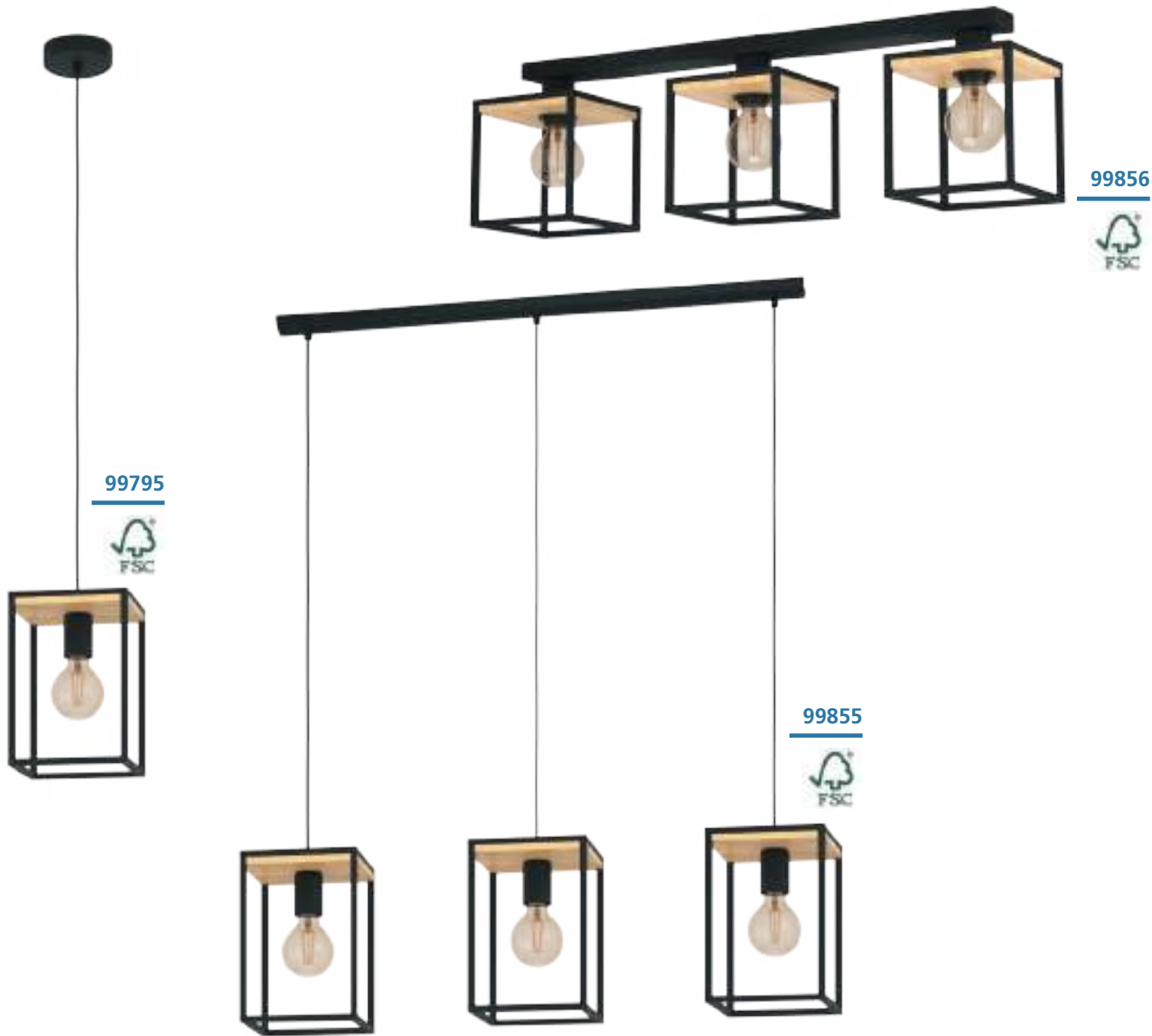

99795 LIBERTAD

pendant light; steel, wood, black, brown
 Hängeleuchte; Stahl, Holz, schwarz, braun
 luminaire en suspension; acier, bois, noir, marron

L 180, B 180, H 1100



99855 LIBERTAD

pendant light; steel, wood, black, brown
 Hängeleuchte; Stahl, Holz, schwarz, braun
 luminaire en suspension; acier, bois, noir, marron

L 880, B 180, H 1100



99856 LIBERTAD

ceiling light; steel, wood, black, brown
 Deckenleuchte; Stahl, Holz, schwarz, braun
 plafonnier; acier, bois, noir, marron

L 860, B 180, H 240

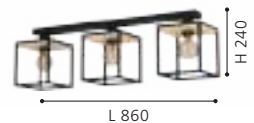



900349



900349 LIBERTAD 1

pendant light; steel, wood, black, brown
 Hängeleuchte; Stahl, Holz, schwarz, braun
 luminaire en suspension; acier, bois, noir, marron

L 760, B 140, H 1100



E27



3x 40W



9 008606 243501

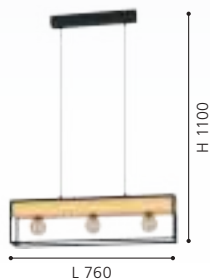

900349

The flower pots are included in these luminaires.

Bei diesen Leuchten sind die Blumentöpfe inkludiert.

Les pots de fleurs sont inclus dans ces luminaires.





99796



99798



99796 LIBERTAD

wall light; steel, wood, black, brown
Wandleuchte; Stahl, Holz, schwarz, braun
Applique; acier, bois, noir, marron

L 140, H 240, A 165



99798 LIBERTAD

floor light; steel, wood, black, brown
Stehleuchte; Stahl, Holz, schwarz, braun
lampadaire; acier, bois, noir, marron

L 180, B 180, H 1285

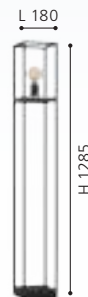

99797 LIBERTAD

table light; steel, wood, black, brown
Tischleuchte; Stahl, Holz, schwarz, braun
luminaire de table; acier, bois, noir, marron

L 140, B 140, H 350

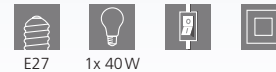



99797





99293 CAMACHO

pendant light; steel, wood, black, brown / plastic, white
 Hängeleuchte; Stahl, Holz, schwarz, braun / Kunststoff, weiss
 luminaire en suspension; acier, bois, noir, marron / plastique, blanc

L 1100, B 60, H 1100



25,5W 3100lm



9 002759 992934

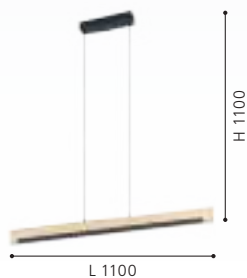

99292 CAMACHO

ceiling light; steel, wood, black, brown / plastic, white
 Deckenleuchte; Stahl, Holz, schwarz, braun / Kunststoff, weiss
 plafonnier; acier, bois, noir, marron / plastique, blanc

L 940, B 80, H 115



2x 10W 2600lm



9 002759 992927

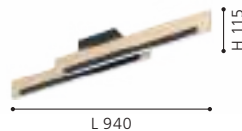

99294 CAMACHO

wall light; steel, wood, black, brown / plastic, white
 Wandleuchte; Stahl, Holz, schwarz, braun / Kunststoff, weiss
 Applique; acier, bois, noir, marron / plastique, blanc

L 440, H 105, A 75



1x 9,6W 1050lm



9 002759 992941



TOUCH
ME



99296



99295



99295, 99296

These luminaires can be switched on and off by touching the specially designed "Touch Me" part of the fixture.

Diese Leuchten können ein- und ausgeschaltet werden, indem man sie an den dafür vorgesehenen „Touch Me“ Bereichen berührt.

Ces luminaires peuvent être éteints et allumés simplement en touchant la partie spécialement conçue pour «Touch Me» du luminaire.

99296 CAMACHO

floor light; steel, wood, black, brown / plastic, white
Stehleuchte; Stahl, Holz, schwarz, braun / Kunststoff, weiss
lampadaire; acier, bois, noir, marron / plastique, blanc

L 75, B 20, H 1260, Base: B 250, T 200



19,5 W



2400 lm



L 75



B 250



9 002759 992965

99295 CAMACHO

table light; steel, wood, black, brown / plastic, white
Tischleuchte; Stahl, Holz, schwarz, braun / Kunststoff, weiss
luminaire de table; acier, bois, noir, marron / plastique, blanc

L 75, B 20, H 405, Base: B 150, T 130



1x 6,5 W



800 lm



L 75



B 150



9 002759 992958



99624 BOYAL

pendant light; steel, wood, black, brown rustic / plastic, white
 Hängeleuchte; Stahl, Holz, schwarz, braun rustikal / Kunststoff, weiss
 luminaire en suspension; acier, bois, noir, marron rustique / plastique, blanc

L 1010, B 400, H 1100

LED warm WHITE LED warm WHITE

2x 12,5W 3600lm 1x 15,5W 2250lm



9 002759 996246

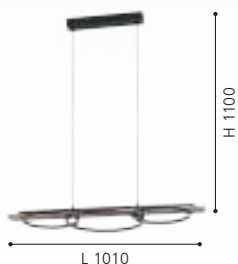

99413 BOYAL

ceiling light; steel, wood, black, brown rustic / plastic, white
 Deckenleuchte; Stahl, Holz, schwarz, braun rustikal / Kunststoff, weiss
 plafonnier; acier, bois, noir, marron rustique / plastique, blanc

L 1010, B 400, H 95

LED warm WHITE LED warm WHITE

2x 12W 3400lm 1x 12W 1700lm



9 002759 994136



99408 BOYAL

ceiling light; steel, wood, black, brown rustic / plastic, white
 Deckenleuchte; Stahl, Holz, schwarz, braun rustikal / Kunststoff, weiss
 plafonnier; acier, bois, noir, marron rustique / plastique, blanc

L 780, B 400, H 90

LED warm WHITE LED warm WHITE

1x 12W 1700lm 1x 12W 1700lm



9 002759 994082





99353



99457



900892



99353 BOYAL

wall light; steel, wood, black, brown rustic / plastic, white
 Wandleuchte; Stahl, Holz, schwarz, braun rustikal / Kunststoff, weiss
 Applique; acier, bois, noir, marron rustique / plastique, blanc

L 300, H 560, A 75



1x 12W 1700lm



9 002759 993535



99457 BOYAL

table light; steel, wood, black, brown rustic / plastic, white
 Tischleuchte; Stahl, Holz, schwarz, braun rustikal / Kunststoff, weiss
 luminaire de table; acier, bois, noir, marron rustique / plastique, blanc

L 300, B 150, H 425, Base: B 110, T 150



1x 12W 1700lm



9 002759 994570



900892 BOYAL

floor light; steel, wood, black, brown rustic / plastic, white
 Stehleuchte; Stahl, Holz, schwarz, braun rustikal / Kunststoff, weiss
 lampadaire; acier, bois, noir, marron rustique / plastique, blanc

L 300, H 1500, Base: B 250, T 200



2x 12W 3400lm



9 008606 274574





99625 BOYAL

pendant light; steel, wood, black, brown / plastic, white
 Hängeleuchte; Stahl, Holz, schwarz, braun / Kunststoff, weiss
 luminaire en suspension; acier, bois, noir, marron / plastique, blanc

L 1010, B 400, H 1100

LED warm WHITE LED warm WHITE

2x 12,5W 3600lm 1x 15,5W 2250lm



9 002759 996253

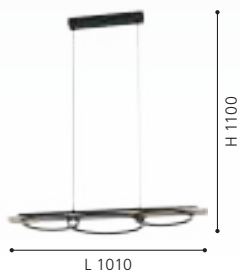

99468 BOYAL

ceiling light; steel, wood, black, brown / plastic, white
 Deckenleuchte; Stahl, Holz, schwarz, braun / Kunststoff, weiss
 plafonnier; acier, bois, noir, marron / plastique, blanc

L 1010, B 400, H 95

LED warm WHITE LED warm WHITE

2x 12W 3400lm 1x 12W 1700lm



9 002759 994686

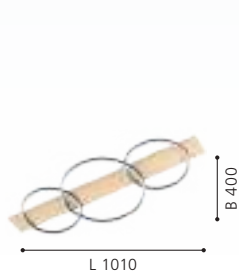

99467 BOYAL

ceiling light; steel, wood, black, brown / plastic, white
 Deckenleuchte; Stahl, Holz, schwarz, braun / Kunststoff, weiss
 plafonnier; acier, bois, noir, marron / plastique, blanc

L 780, B 400, H 90

LED warm WHITE LED warm WHITE

1x 12W 1700lm 1x 12W 1700lm



9 002759 994679





99469

LED



99466

LED

99469 BOYAL

table light; steel, wood, black, brown / plastic, white
Tischleuchte; Stahl, Holz, schwarz, braun / Kunststoff, weiss
luminaire de table; acier, bois, noir, marron / plastique, blanc

L 300, B 150, H 425, Base: B 110, T 150



1x 12W 1700lm



9 002759 994693



99466 BOYAL

wall light; steel, wood, black, brown / plastic, white
Wandleuchte; Stahl, Holz, schwarz, braun / Kunststoff, weiss
Applique; acier, bois, noir, marron / plastique, blanc

L 300, H 560, A 75



1x 12W 1700lm



9 002759 994662

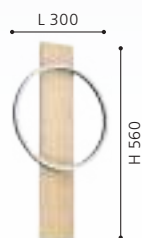



900489



900488



900491



900489 PANAGRIA

pendant light; aluminium, steel, wood, black, brown / plastic, white

Hängeleuchte; Alu, Stahl, Holz, schwarz, braun / Kunststoff, weiss

luminaire en suspension; aluminium, acier, bois, noir, marron / plastique, blanc

L 935, B 75, H 1100



2x 13W 3120lm



9 008606 244249

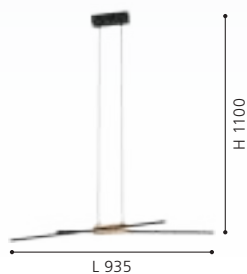

900488 PANAGRIA

ceiling light; aluminium, steel, wood, black, brown / plastic, white

Deckenleuchte; Alu, Stahl, Holz, schwarz, braun / Kunststoff, weiss

plafonnier; aluminium, acier, bois, noir, marron / plastique, blanc

L 935, B 75, H 110



2x 13W 3120lm



9 008606 244232

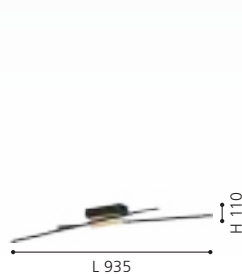

900491 PANAGRIA

wall light; aluminium, steel, wood, black, brown / plastic, white

Wandleuchte; Alu, Stahl, Holz, schwarz, braun / Kunststoff, weiss

Applique; aluminium, acier, bois, noir, marron / plastique, blanc

L 75, H 540, A 85



2x 6,3W 1510lm



9 008606 244256



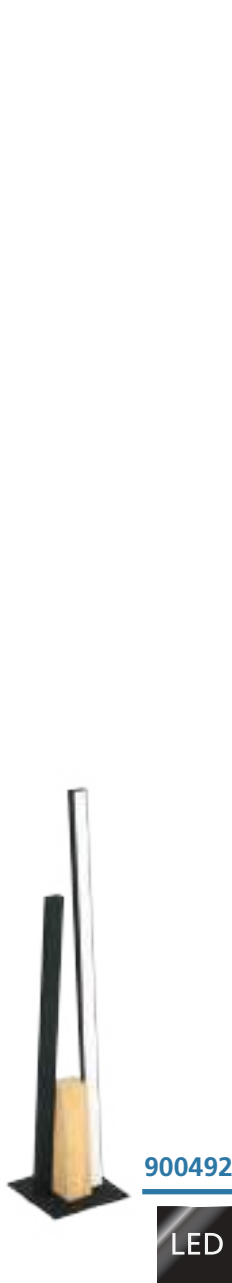

900492



900493



DESIGN
HIGHLIGHT
DETAIL



900492 PANAGRIA

table light; aluminium, steel, wood, black, brown / plastic, white
Tischleuchte; Alu, Stahl, Holz, schwarz, braun / Kunststoff, weiss
luminaire de table; aluminium, acier, bois, noir, marron /
plastique, blanc

L 75, B 45, H 455, Base: B 100, T 100



1x 6,8W 1440lm 1x 5,2W



9 008606 244263



900493 PANAGRIA

floor light; aluminium, steel, wood, black, brown / plastic, white
Stehleuchte; Alu, Stahl, Holz, schwarz, braun / Kunststoff, weiss
lampadaire; aluminium, acier, bois, noir, marron / plastique,
blanc

L 85, B 75, H 1460, Base: B 160, T 160



1x 12,8W 2880lm 1x 11,2W



9 008606 244270





99545



99544

99545 CANTERRAS

pendant light; steel, black / terrazzo, grey, white
 Hängeleuchte; Stahl, schwarz / Terrazzo, grau, weiss
 luminaire en suspension; acier, noir / terrazzo, gris, blanc

L 975, B 150, H 1100



99544 CANTERRAS

pendant light; steel, black / terrazzo, grey, white
 Hängeleuchte; Stahl, schwarz / Terrazzo, grau, weiss
 luminaire en suspension; acier, noir / terrazzo, gris, blanc

H 1100, Ø 150

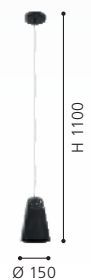



99546



99547



99546 CANTERRAS

wall light; steel, black / terrazzo, grey, white
Wandleuchte; Stahl, schwarz / Terrazzo, grau, weiss
Applique; acier, noir / terrazzo, gris, blanc

L 150, H 320, A 275



E27



1x 40W



9 002759 995461



99547 CANTERRAS

floor light; steel, black / terrazzo, grey, white
Stehleuchte; Stahl, schwarz / Terrazzo, grau, weiss
lampadaire; acier, noir / terrazzo, gris, blanc

L 430, B 150, H 1785, Base: Ø 300



E27



1x 40W



9 002759 995478





99513



99512

99513 ABREOSA

floor light; steel, black, grey
Stehleuchte; Stahl, schwarz, grau
lampadaire; acier, noir, gris

L 370, B 280, H 1510, Base: Ø 250



E27 1x 28W



9 002759 995133



99512 ABREOSA

pendant light; steel, black, grey
Hängeleuchte; Stahl, schwarz, grau
luminaire en suspension; acier, noir, gris

L 1080, B 280, H 1100



E27 3x 28W



9 002759 995126



99511 ABREOSA

pendant light; steel, black, grey
Hängeleuchte; Stahl, schwarz, grau
luminaire en suspension; acier, noir, gris

H 1100, Ø 280



E27 1x 28W



9 002759 995119

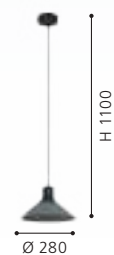



99511





900907



900907

This wall lamps have an on/off switch on the baldachin.

Diese Wandleuchten verfügen über einen ein/aus-Schalter am Baldachin.

Ces appliques disposent d'un interrupteur marche/arrêt sur le baldachin.



900909



900908



900907 ALMUDAINA

wall light; steel, black
Wandleuchte; Stahl, schwarz
Applique; acier, noir

L 110, H 200, A 200



1x 5W



480lm



900909 ALMUDAINA

floor light; steel, black
Stehleuchte; Stahl, schwarz
lampadaire; acier, noir

H 1570, Base: Ø 270



1x 5W



480lm



900908 ALMUDAINA

table light; steel, black
Tischleuchte; Stahl, schwarz
luminaire de table; acier, noir

H 495, Base: Ø 170



1x 5W



480lm



9 008606 274116



9 008606 274130



9 008606 274123



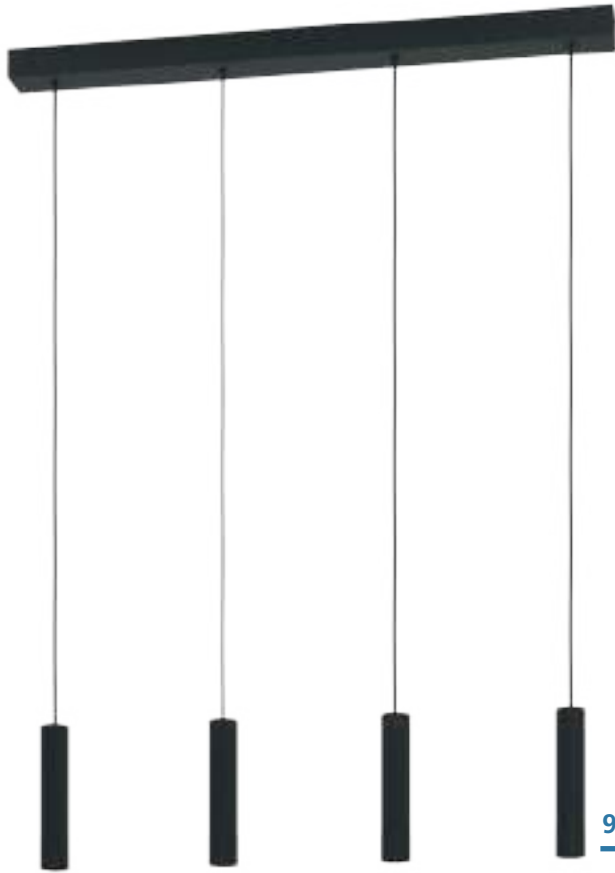

900906

LED



900926

LED

900906 ALMUDAINA

pendant light; steel, black
Hängeleuchte; Stahl, schwarz
luminaire en suspension; acier, noir

L 840, B 60, H 1100

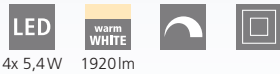

4x 5,4W 1920lm



9 008606 274109

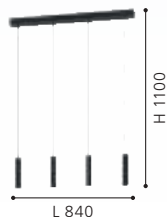

900926 ALMUDAINA

pendant light; steel, black
Hängeleuchte; Stahl, schwarz
luminaire en suspension; acier, noir

H 1100, Ø 40



1x 5W 480lm



9 008606 281817



ALMUDAINA

The heads of the wall lamp, table lights and the floor lamp of the Almudaina series can be swiveled to the right and left as well as, down and up.

Die Köpfe der Wandleuchte, Tischleuchte und der Stehleuchte der Serie Almudaina lassen sich nach rechts und links sowie, nach unten und nach oben schwenken.

Les têtes de la lampe murale, les lumières de la table et la lampe à l'ordre de la série Almudaina peuvent être pivotés à droite et à gauche ainsi que, en bas et en haut.



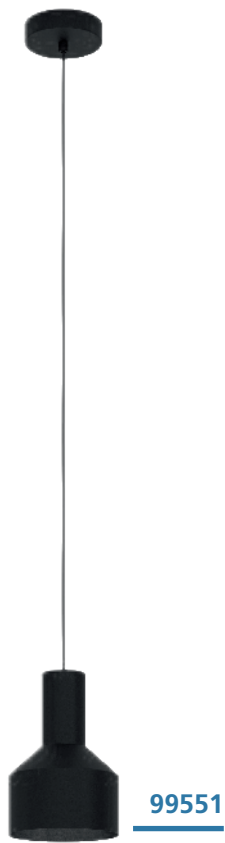

99551

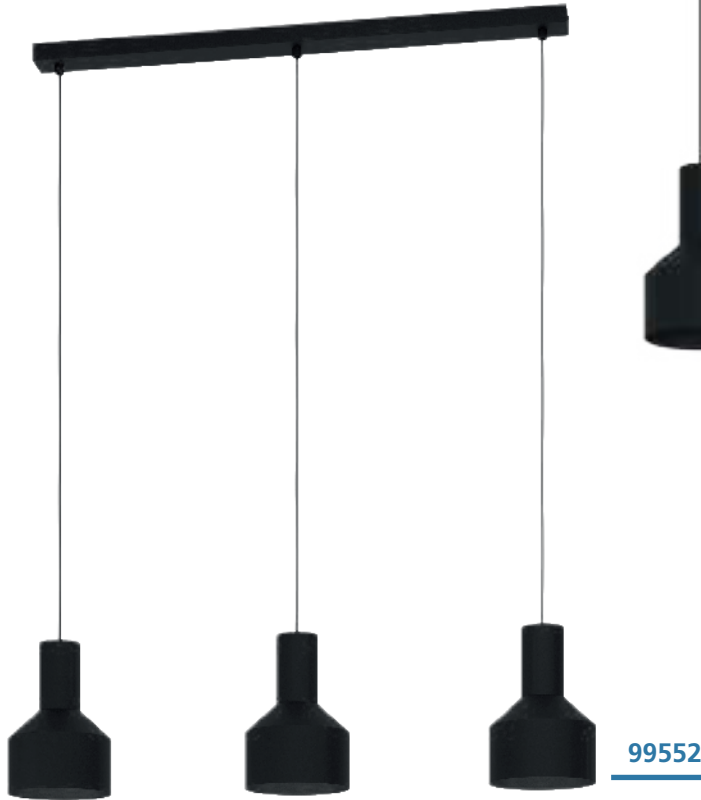

99552



99553

99551 CASIBARE

pendant light; steel, black
Hängeleuchte; Stahl, schwarz
luminaire en suspension; acier, noir

H 1100, Ø 150



E27 1x 40W



9 002759 995515



99552 CASIBARE

pendant light; steel, black
Hängeleuchte; Stahl, schwarz
luminaire en suspension; acier, noir

L 850, B 150, H 1100



E27 3x 40W



9 002759 995522

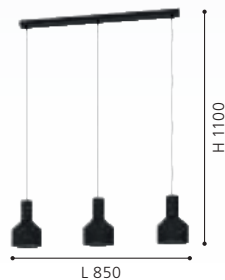

99553 CASIBARE

pendant light; steel, black
Hängeleuchte; Stahl, schwarz
luminaire en suspension; acier, noir

H 1500, Ø 710



E27 5x 40W



9 002759 995539





99554



99555

99554 CASIBARE

table light; steel, black
Tischleuchte; Stahl, schwarz
luminaire de table; acier, noir

L 160, B 120, H 490, Base: Ø 155



E27 1x 28W



9 002759 995546



99555 CASIBARE

floor light; steel, black
Stehleuchte; Stahl, schwarz
lampadaire; acier, noir

L 350, B 120, H 1605, Base: Ø 250



E27 2x 28W



9 002759 995553

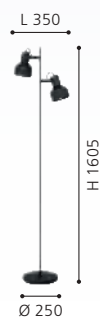



99345



900164



99346

99345 CREMELLA

pendant light; steel, black
Hängeleuchte; Stahl, schwarz
luminaire en suspension; acier, noir

H 1100, Ø 370



E27 1x 40W



9 002759 993450



900164 CREMELLA

ceiling light; steel, black
Deckenleuchte; Stahl, schwarz
plafonnier; acier, noir

H 260, Ø 370



E27 1x 60W



9 008606 234417

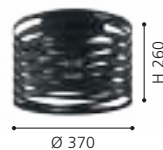

99346 CREMELLA

pendant light; steel, black
Hängeleuchte; Stahl, schwarz
luminaire en suspension; acier, noir

H 1100, Ø 180

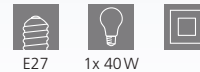

E27 1x 40W



9 002759 993467

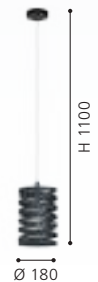



99347



99506



99507

99347 CREMELLA

pendant light; steel, black
Hängeleuchte; Stahl, schwarz
luminaire en suspension; acier, noir

L 940, B 180, H 1100



E27 3x 40W



9 002759 993474

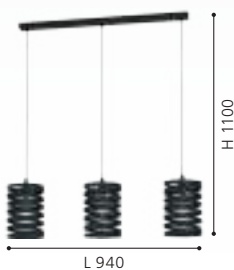

99506 CREMELLA

table light; steel, black
Tischleuchte; Stahl, schwarz
luminaire de table; acier, noir

H 290, Ø 180, Base: Ø 180



E27 1x 40W



9 002759 995065



99507 CREMELLA

floor light; steel, black
Stehleuchte; Stahl, schwarz
lampadaire; acier, noir

H 1510, Ø 370, Base: Ø 250



E27 1x 40W



9 002759 995072

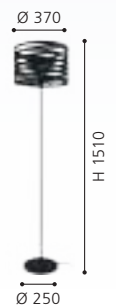



900494

900495

900494 ROMAZZINA

pendant light; steel, black
 Hängeleuchte; Stahl, schwarz
 luminaire en suspension; acier, noir

H 1100, Ø 325



900495 ROMAZZINA

pendant light; steel, black
 Hängeleuchte; Stahl, schwarz
 luminaire en suspension; acier, noir

L 900, B 200, H 1100





900686



900495 | 900519 | 900686



900494 | 900522



900519



900522

900686 ROMAZZINA

pendant light; steel, black
Hängeleuchte; Stahl, schwarz
luminaire en suspension; acier, noir

H 1100, Ø 460



900519 ROMAZZINA

table light; steel, black
Tischleuchte; Stahl, schwarz
luminaire de table; acier, noir

H 435, Ø 200, Base: Ø 225



900522 ROMAZZINA

floor light; steel, black
Stehleuchte; Stahl, schwarz
lampadaire; acier, noir

H 1405, Ø 325, Base: Ø 630

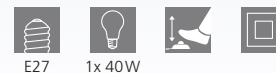



900687



900496



DESIGN
HIGHLIGHT
DETAIL

900687 ROMAZZINA

pendant light; steel, sandy
Hängeleuchte; Stahl, sandfarben
luminaire en suspension; acier, couleur sable

H 1100, Ø 460



9 008606 258574



900496 ROMAZZINA

pendant light; steel, sandy
Hängeleuchte; Stahl, sandfarben
luminaire en suspension; acier, couleur sable

H 1100, Ø 325

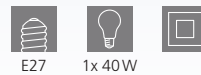

9 008606 244300





900497 | 900521 | 900687



900496 | 900523



900497 ROMAZZINA

pendant light; steel, sandy
Hängeleuchte; Stahl, sandfarben
luminaire en suspension; acier, couleur sable

L 900, B 200, H 1100



E27 3x 40W



900521 ROMAZZINA

table light; steel, sandy
Tischleuchte; Stahl, sandfarben
luminaire de table; acier, couleur sable

H 435, Ø 200, Base: Ø 225

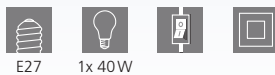

E27 1x 40W



900523 ROMAZZINA

floor light; steel, sandy
Stehleuchte; Stahl, sandfarben
lampadaire; acier, couleur sable

H 1405, Ø 325, Base: Ø 630

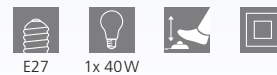

E27 1x 40W





900165



900166



900167

900165 VENEZUELA

ceiling light; steel, black, gold
Deckenleuchte; Stahl, schwarz, gold
plafonnier; acier, noir, or

H 250, Ø 385



E27 1x 40W



9 008606 242771



900166 VENEZUELA

pendant light; steel, black, gold
Hängeleuchte; Stahl, schwarz, gold
luminaire en suspension; acier, noir, or

H 1100, Ø 235



E27 1x 40W



9 008606 242788



900167 VENEZUELA

pendant light; steel, black, gold
Hängeleuchte; Stahl, schwarz, gold
luminaire en suspension; acier, noir, or

L 935, B 235, H 1100



E27 3x 40W



9 008606 242795

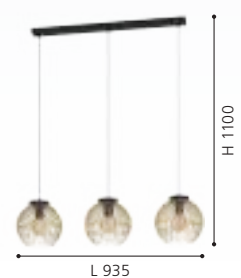



900168

900168 VENEZUELA

table light; steel, black, gold
Tischleuchte; Stahl, schwarz, gold
luminaire de table; acier, noir, or

H 225, Ø 235, Base: Ø 115



E27



1x 40W





99806



99807



99809

99806 ESCANDIDOS

pendant light; steel, black, brass / steel, black, gold
 Hängeleuchte; Stahl, schwarz, messing / Stahl, schwarz, gold
 luminaire en suspension; acier, noir, laiton / acier, noir, or

H 1100, Ø 220



E27 1x 40W



9 002759 998066

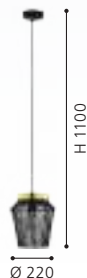

99807 ESCANDIDOS

pendant light; steel, black, brass / steel, black, gold
 Hängeleuchte; Stahl, schwarz, messing / Stahl, schwarz, gold
 luminaire en suspension; acier, noir, laiton / acier, noir, or

L 920, B 220, H 1100



E27 3x 40W



9 002759 998073



99809 ESCANDIDOS

floor light; steel, black, brass / steel, black, gold
 Stehleuchte; Stahl, schwarz, messing / Stahl, schwarz, gold
 lampadaire; acier, noir, laiton / acier, noir, or

L 310, B 220, H 1700, Base: B 300, T 200



E27 1x 40W



9 002759 998097





99808 ESCANDIDOS

table light; steel, black, brass / steel, black, gold
Tischleuchte; Stahl, schwarz, messing / Stahl, schwarz, gold
luminaire de table; acier, noir, laiton / acier, noir, or

H 260, Ø 220, Base: Ø 150



E27



1x 40W





900177



900177 LURONE

pendant light; steel, black, brass
Hängeleuchte; Stahl, schwarz, messing
luminaire en suspension; acier, noir, laiton

L 1000, B 50, H 1100



E27



4x 10W



9 008606 241132

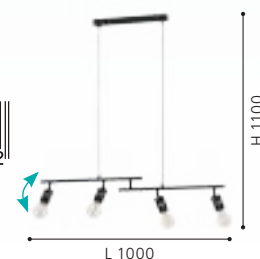



900176



900178



900179

900176 LURONE

ceiling light; steel, black, brass
Deckenleuchte; Stahl, schwarz, messing
plafonnier; acier, noir, laiton

L 1000, B 50, H 270

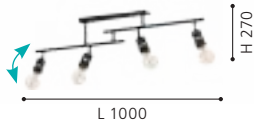

900178 LURONE

table light; steel, black, brass
Tischleuchte; Stahl, schwarz, messing
luminaire de table; acier, noir, laiton

L 205, B 50, H 500, Base: Ø 200



900179 LURONE

floor light; steel, black, brass
Stehleuchte; Stahl, schwarz, messing
lampadaire; acier, noir, laiton

L 205, B 50, H 1600, Base: Ø 250

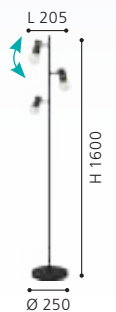



900731



900732

900731 ESCANDELL

pendant light; steel, black, brushed brass
 Hängeleuchte; Stahl, schwarz, messing-gebürstet
 luminaire en suspension; acier, noir, laiton brossé

H 1100, Ø 250

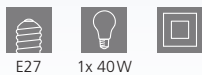

900732 ESCANDELL

pendant light; steel, black, brushed brass
 Hängeleuchte; Stahl, schwarz, messing-gebürstet
 luminaire en suspension; acier, noir, laiton brossé

L 950, B 250, H 1100

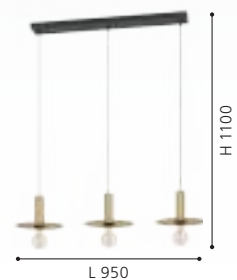



900733



EGLO
RECOMMENDS
110079
ESCANDELL



900734



900735

900733 ESCANDELL

wall light; steel, brushed brass
Wandleuchte; Stahl, messing-gebürstet
Applique; acier, laiton brossé

L 250, H 120, A 270



E27 1x 40W



9 008606 273898

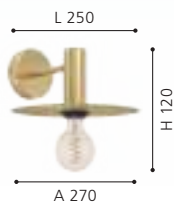

900734 ESCANDELL

table light; steel, brushed brass
Tischleuchte; Stahl, messing-gebürstet
luminaire de table; acier, laiton brossé

L 220, B 230, H 470, Base: Ø 220



E27 1x 40W



9 008606 273904

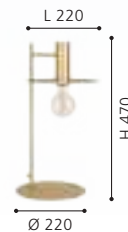

900735 ESCANDELL

floor light; steel, brushed brass
Stehleuchte; Stahl, messing-gebürstet
lampadaire; acier, laiton brossé

L 270, B 250, H 1560, Base: Ø 270

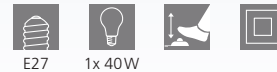

E27 1x 40W



9 008606 273911





900843



900843

These luminaires can be mounted wider or narrower according to the customer's requirements due to the mounting knobs.

Diese Leuchten können aufgrund der Befestigungsknöpfe je nach Kundenwunsch weiter oder enger montiert werden.

Grâce aux boutons de fixation, ces luminaires peuvent être montés plus ou moins loin, selon les souhaits du client.



99593

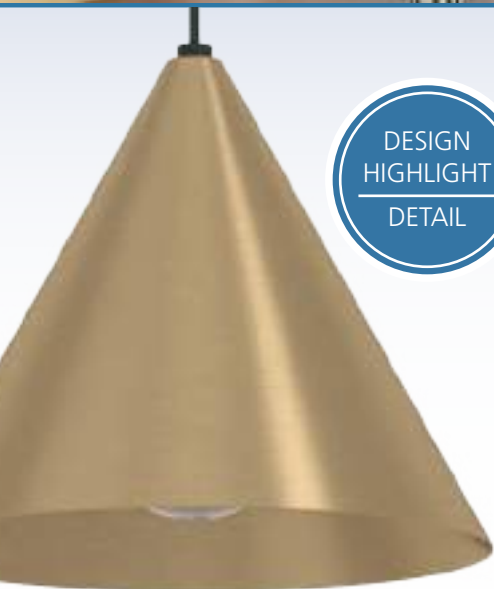

DESIGN
HIGHLIGHT
DETAIL

900843 NARICES 1

pendant light; steel, black / steel, brushed brass, gold
Hängeleuchte; Stahl, schwarz / Stahl, messing-gebürstet, gold
luminaire en suspension; acier, noir / acier, laiton brossé, or

L 1730, B 260, H 1100



E27 2x 40W



9 008606 270286



99593 NARICES

table light; steel, black / steel, brushed brass, gold
Tischleuchte; Stahl, schwarz / Stahl, messing-gebürstet, gold
luminaire de table; acier, noir / acier, laiton brossé, or

L 295, B 220, H 500, Base: Ø 220



E27 1x 40W



9 002759 995935

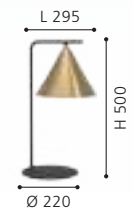



99592 NARICES

pendant light; steel, black / steel, brushed brass, gold
 Hängeleuchte; Stahl, schwarz / Stahl, messing-gebürstet, gold
 luminaire en suspension; acier, noir / acier, laiton brossé, or

L 920, B 220, H 1100

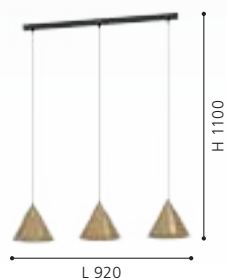

99591 NARICES

pendant light; steel, black / steel, brushed brass, gold
 Hängeleuchte; Stahl, schwarz / Stahl, messing-gebürstet, gold
 luminaire en suspension; acier, noir / acier, laiton brossé, or

H 1100, Ø 220

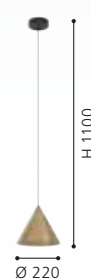
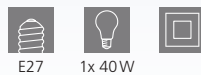

99594 NARICES

floor light; steel, black / steel, brushed brass, gold
 Stehleuchte; Stahl, schwarz / Stahl, messing-gebürstet, gold
 lampadaire; acier, noir / acier, laiton brossé, or

L 295, B 220, H 1620, Base: Ø 270

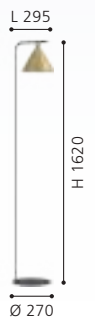



900873

LED



900872

LED

900873 BARBOTTO

pendant light; steel, black, gold
 Hängeleuchte; Stahl, schwarz, gold
 luminaire en suspension; acier, noir, or

L 925, B 60, H 1100

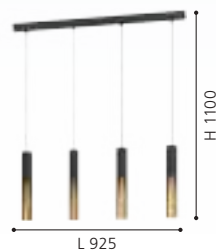
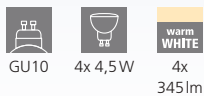

900872 BARBOTTO

pendant light; steel, black, gold
 Hängeleuchte; Stahl, schwarz, gold
 luminaire en suspension; acier, noir, or

H 1100, Ø 60

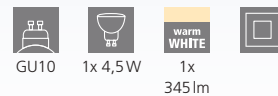



97583

LED

97584

LED

97583 BARBOTTO

table light; steel, black, gold
Tischleuchte; Stahl, schwarz, gold
luminaire de table; acier, noir, or

H 395, Ø 60, Base: Ø 100

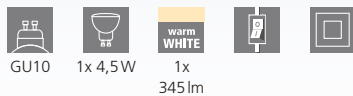

GU10 1x 4,5W 1x 345lm



9 002759 975838



97584 BARBOTTO

floor light; steel, black, gold
Stehleuchte; Stahl, schwarz, gold
lampadaire; acier, noir, or

H 1370, Ø 60, Base: Ø 185

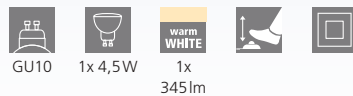

GU10 1x 4,5W 1x 345lm



9 002759 975845

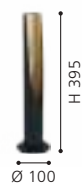



900875



900876



900875 BARBOTTO

pendant light; steel, wood, black, brown
 Hängeleuchte; Stahl, Holz, schwarz, braun
 luminaire en suspension; acier, bois, noir, marron

L 925, B 60, H 1100

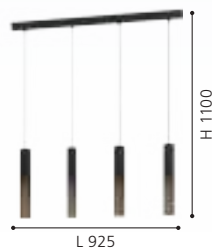
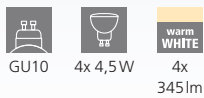

900876 BARBOTTO

table light; steel, wood, black, brown
 Tischleuchte; Stahl, Holz, schwarz, braun
 luminaire de table; acier, bois, noir, marron

H 395, Ø 60, Base: Ø 100

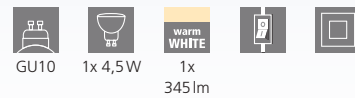



900877

LED



900874

LED

900877 BARBOTTO

floor light; steel, wood, black, brown
Stehleuchte; Stahl, Holz, schwarz, braun
lampadaire; acier, bois, noir, marron

H 1365, Ø 60, Base: Ø 185



GU10



1x 4,5W



1x
345lm



9 008606 270347



900874 BARBOTTO

pendant light; steel, wood, black, brown
Hängeleuchte; Stahl, Holz, schwarz, braun
luminaire en suspension; acier, bois, noir, marron

H 1100, Ø 60



GU10



1x 4,5W



1x
345lm



9 008606 270316

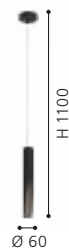



99098



99096



99097

99098 ERSEKA

pendant light; steel, brass / brilliant glass, clear
 Hängeleuchte; Stahl, messing / Brillantglas, klar
 luminaire en suspension; acier, laiton / verre brillant, transparent

H 1300, Ø 385



99097 ERSEKA

pendant light; steel, brass / brilliant glass, clear
 Hängeleuchte; Stahl, messing / Brillantglas, klar
 luminaire en suspension; acier, laiton / verre brillant, transparent

H 1450, Ø 485



99096 ERSEKA

ceiling light; steel, brass / brilliant glass, clear
 Deckenleuchte; Stahl, messing / Brillantglas, klar
 plafonnier; acier, laiton / verre brillant, transparent

H 535, Ø 485

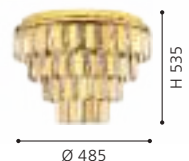



99095



99094



99093



ERSEKA

99095 ERSEKA

pendant light; steel, chrome / brilliant glass, clear
 Hängeleuchte; Stahl, chrom / Brillantglas, klar
 luminaire en suspension; acier, chrome / verre brillant, transparent

H 1300, Ø 385



E14 5x 40W



9 002759 990954



99094 ERSEKA

pendant light; steel, chrome / brilliant glass, clear
 Hängeleuchte; Stahl, chrom / Brillantglas, klar
 luminaire en suspension; acier, chrome / verre brillant, transparent

H 1450, Ø 485

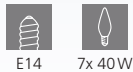

E14 7x 40W



9 002759 990947



99093 ERSEKA

ceiling light; steel, chrome / brilliant glass, clear
 Deckenleuchte; Stahl, chrom / Brillantglas, klar
 plafonnier; acier, chrome / verre brillant, transparent

H 535, Ø 485



E14 7x 40W



9 002759 990930





900305



MANZANARES

900305 MANZANARES

pendant light; steel, brushed brass, gold / matte-opal glass, white

Hängeleuchte; Stahl, messing-gebürstet, gold / Glas opal-matt, weiss

luminaire en suspension; acier, laiton brossé, or / verre opale mat, blanc

H 1100, Ø 225



E27



1x 40W



9 008606 235902

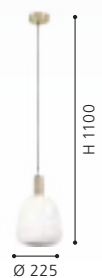



900306



900304



900307

900306 MANZANARES

pendant light; steel, brushed brass, gold / matte-opal glass, white

Hängeleuchte; Stahl, messing-gebürstet, gold / Glas opal-matt, weiss

luminaire en suspension; acier, laiton brossé, or / verre opale mat, blanc

L 970, B 145, H 1100



E27 4x 40W



9 008606 235919

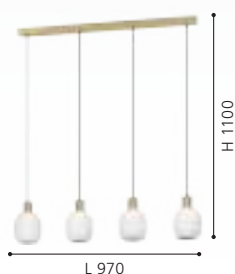

L 970

H 1100

900304 MANZANARES

ceiling light; steel, brushed brass, gold / matte-opal glass, white
Deckenleuchte; Stahl, messing-gebürstet, gold / Glas opal-matt, weiss

plafonnier; acier, laiton brossé, or / verre opale mat, blanc

H 190, Ø 450



E27 3x 40W



9 008606 235896

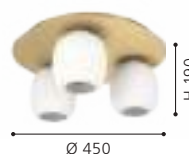

Ø 450

H 190

900307 MANZANARES

table light; steel, brushed brass, gold / matte-opal glass, white
Tischleuchte; Stahl, messing-gebürstet, gold / Glas opal-matt, weiss

luminaire de table; acier, laiton brossé, or / verre opale mat, blanc

H 180, Ø 145, Base: Ø 90

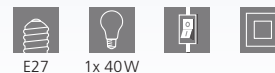

E27 1x 40W



9 008606 235926



Ø 90

H 180



85261



85262

85261 RONDO

pendant light; steel, satin nickel / matte-opal glass, white
 Hängeleuchte; Stahl, nickel-matt / Glas opal-matt, weiss
 luminaire en suspension; acier, nickel mat / verre opale mat, blanc

H 1100, Ø 200



85262 RONDO

pendant light; steel, satin nickel / matte-opal glass, white
 Hängeleuchte; Stahl, nickel-matt / Glas opal-matt, weiss
 luminaire en suspension; acier, nickel mat / verre opale mat, blanc

H 1100, Ø 250

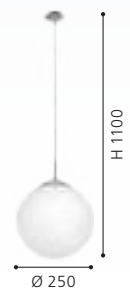



85263



91589



85264



EGLO
RECOMMENDS
110033

RONDO

85263 RONDO

pendant light; steel, satin nickel / matte-opal glass, white
Hängeleuchte; Stahl, nickel-matt / Glas opal-matt, weiss
luminaire en suspension; acier, nickel mat / verre opale mat, blanc

H 1100, Ø 300



E27 1x 60W



9 002759 852634

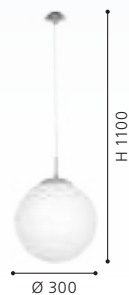

91589 RONDO

ceiling light; steel, satin nickel / matte-opal glass, white
Deckenleuchte; Stahl, nickel-matt / Glas opal-matt, weiss
plafonnier; acier, nickel mat / verre opale mat, blanc

H 315, Ø 250



E27 1x 60W



9 002759 915896

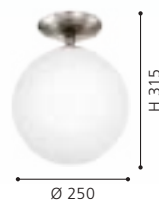

85264 RONDO

table light; plastic, white / matte-opal glass, white
Tischleuchte; Kunststoff, weiss / Glas opal-matt, weiss
luminaire de table; plastique, blanc / verre opale mat, blanc

H 200, Ø 200

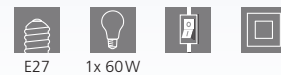

E27 1x 60W



9 002759 852641

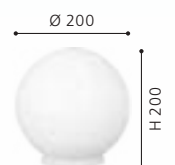



900395

900512

The flower pots are included in these luminaires.

Bei diesen Leuchten sind die Blumentöpfe inkludiert.

Les pots de fleurs sont inclus dans ces luminaires.

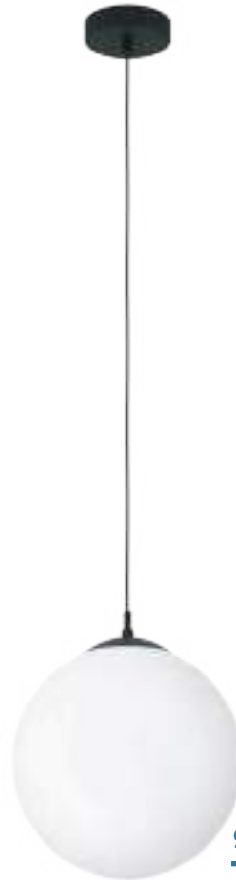

900511



900395 RONDO

pendant light; steel, satin nickel / matte-opal glass, white
 Hängeleuchte; Stahl, nickel-matt / Glas opal-matt, weiss
 luminaire en suspension; acier, nickel mat / verre opale mat, blanc

L 960, B 200, H 1100



E27

3x 40W



9 008606 239467

900511 RONDO 3

pendant light; steel, black / matte-opal glass, white
 Hängeleuchte; Stahl, schwarz / Glas opal-matt, weiss
 luminaire en suspension; acier, noir / verre opale mat, blanc

H 1100, Ø 300



E27

1x 40W



9 008606 244409

900512 RONDO 3

pendant light; steel, black / matte-opal glass, white
 Hängeleuchte; Stahl, schwarz / Glas opal-matt, weiss
 luminaire en suspension; acier, noir / verre opale mat, blanc

L 1210, B 200, H 1100



E27

3x 40W

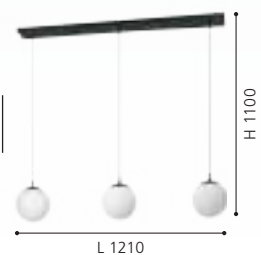

9 008606 244416



900512



86817



86817 OPTICA

floor light; steel, satin nickel / matte-opal glass, white
Stehleuchte; Stahl, nickel-matt / Glas opal-matt, weiss
lampadaire; acier, nickel mat / verre opale mat, blanc

H 1570, Ø 350



E27



2x 60W



Ø 350

H 1570





86811



86812

86811 OPTICA

wall/ceiling light; steel, satin nickel / matte-opal glass, white
Wand- / Deckenleuchte; Stahl, nickel-matt / Glas opal-matt, weiss
Applique/Plafonnier; acier, nickel mat / verre opale mat, blanc

H 160, Ø 280



E27 2x 60W

86812 OPTICA

wall/ceiling light; steel, satin nickel / matte-opal glass, white
Wand- / Deckenleuchte; Stahl, nickel-matt / Glas opal-matt, weiss
Applique/Plafonnier; acier, nickel mat / verre opale mat, blanc

H 210, Ø 350

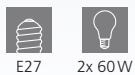

E27 2x 60W



9 002759 868116

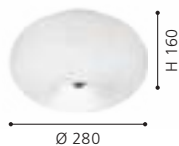

9 002759 868123



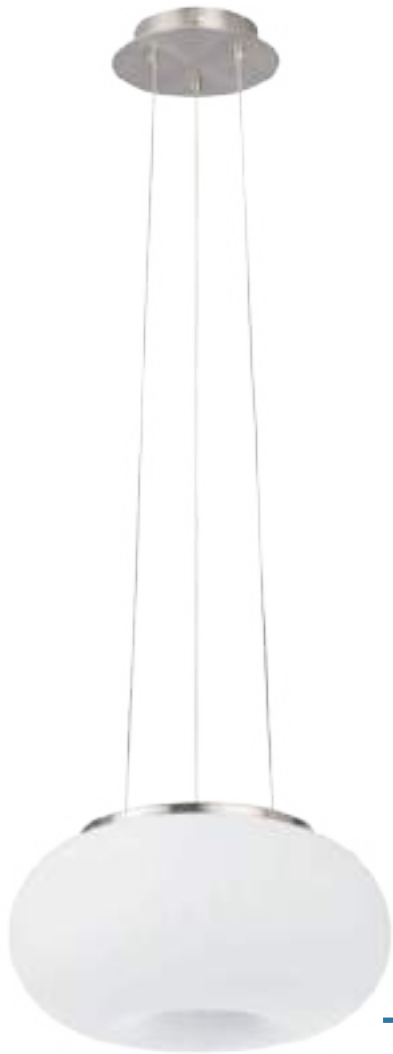

86813



86814



OPTICA

86813 OPTICA

pendant light; steel, satin nickel / matte-opal glass, white
 Hängeleuchte; Stahl, nickel-matt / Glas opal-matt, weiss
 luminaire en suspension; acier, nickel mat / verre opale mat, blanc

H 1100, Ø 280



86814 OPTICA

pendant light; steel, satin nickel / matte-opal glass, white
 Hängeleuchte; Stahl, nickel-matt / Glas opal-matt, weiss
 luminaire en suspension; acier, nickel mat / verre opale mat, blanc

H 1100, Ø 350



86815 OPTICA

pendant light; steel, satin nickel / matte-opal glass, white
 Hängeleuchte; Stahl, nickel-matt / Glas opal-matt, weiss
 luminaire en suspension; acier, nickel mat / verre opale mat, blanc

H 1100, Ø 445





86815



99631



99632



DESIGN
HIGHLIGHT
DETAIL



33984

99631 GOROSIBA 1

ceiling light; steel, black / glass vaporized, black-transparent
Deckenleuchte; Stahl, schwarz / Glas bedampft, schwarz-transparent
plafonnier; acier, noir / verre vaporisé, noir transparent

H 175, Ø 450



E27

3x 40W

99632 GOROSIBA 1

ceiling light; steel, black / glass vaporized, black-transparent
Deckenleuchte; Stahl, schwarz / Glas bedampft, schwarz-transparent
plafonnier; acier, noir / verre vaporisé, noir transparent

L 380, B 380, H 170



E27

4x 40W

33984 GOROSIBA

table light; steel, black / glass vaporized, black-transparent
Tischleuchte; Stahl, schwarz / Glas bedampft, schwarz-transparent
luminaire de table; acier, noir / verre vaporisé, noir transparent

H 220, Ø 150, Base: Ø 100



E27

1x 60W



9 002759 996314



9 002759 996321



9 002759 339845





98752 GOROSIBA

pendant light; steel, black / glass vaporized, black-transparent
 Hängeleuchte; Stahl, schwarz / Glas bedampft, schwarz-transparent
 luminaire en suspension; acier, noir / verre vaporisé, noir transparent

H 1100, Ø 150

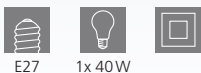

98753 GOROSIBA

pendant light; steel, black / glass vaporized, black-transparent
 Hängeleuchte; Stahl, schwarz / Glas bedampft, schwarz-transparent
 luminaire en suspension; acier, noir / verre vaporisé, noir transparent

L 850, B 150, H 1100



98754 GOROSIBA

pendant light; steel, black / glass vaporized, black-transparent
 Hängeleuchte; Stahl, schwarz / Glas bedampft, schwarz-transparent
 luminaire en suspension; acier, noir / verre vaporisé, noir transparent

H 1300, Ø 410





900341



900342



900341 PINTO TEXTIL 1

pendant light; steel, black / glass, fabric, clear, black
 Hängeleuchte; Stahl, schwarz / Glas, Textil, klar, schwarz
 luminaire en suspension; acier, noir / verre, tissu, transparent, noir

H 1100, Ø 120



E27 1x 10W



9 008606 235681



900342 PINTO TEXTIL 1

pendant light; steel, black / glass, fabric, clear, black
 Hängeleuchte; Stahl, schwarz / Glas, Textil, klar, schwarz
 luminaire en suspension; acier, noir / verre, tissu, transparent, noir

L 820, B 120, H 1100



E27 3x 10W



9 008606 235698

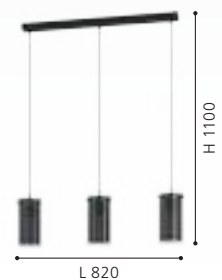



99286



99287



99286 | 99287



99288



99288

99286 PINTO TEXTIL

pendant light; steel, satin nickel / glass, fabric, clear, grey
Hängeleuchte; Stahl, nickel-matt / Glas, Textil, klar, grau
luminaire en suspension; acier, nickel mat / verre, tissu, transparent, gris

L 820, B 120, H 1100



E27 3x 16W



9 002759 992866

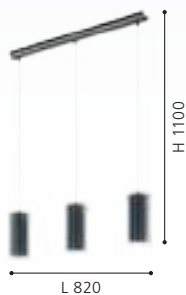

99287 PINTO TEXTIL

pendant light; steel, satin nickel / glass, fabric, clear, grey
Hängeleuchte; Stahl, nickel-matt / Glas, Textil, klar, grau
luminaire en suspension; acier, nickel mat / verre, tissu, transparent, gris

L 945, B 120, H 1100



E27 4x 16W



9 002759 992873



99288 PINTO TEXTIL

wall light; steel, satin nickel / glass, fabric, clear, grey
Wandleuchte; Stahl, nickel-matt / Glas, Textil, klar, grau
Applique; acier, nickel mat / verre, tissu, transparent, gris

L 120, H 445, A 180



E27 1x 16W



9 002759 992880





90304



90304 PINTO NERO

pendant light; steel, satin nickel / smoked glass, matte-opal glass, black-transparent, white
 Hängeleuchte; Stahl, nickel-matt / Rauchglas, Glas opal-matt, schwarz-transparent, weiss
 luminaire en suspension; acier, nickel mat / verre fumé, verre opale mat, noir transparent, blanc
 H 1100, Ø 110



90305 PINTO NERO

pendant light; steel, satin nickel / smoked glass, matte-opal glass, black-transparent, white
 Hängeleuchte; Stahl, nickel-matt / Rauchglas, Glas opal-matt, schwarz-transparent, weiss
 luminaire en suspension; acier, nickel mat / verre fumé, verre opale mat, noir transparent, blanc
 L 725, H 1100

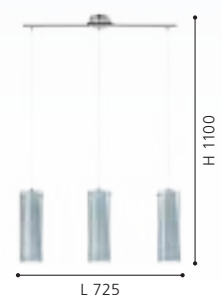

90305





97653



97651

97839

97653 PINTO GOLD

pendant light; steel, black / glass, clear, gold
 Hängeleuchte; Stahl, schwarz / Glas, klar, gold
 luminaire en suspension; acier, noir / verre, transparent, or

L 905, B 360, H 1100



E27

4x 40W

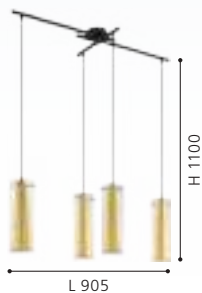

9 002759 976538

97651 PINTO GOLD

pendant light; steel, black / glass, clear, gold
 Hängeleuchte; Stahl, schwarz / Glas, klar, gold
 luminaire en suspension; acier, noir / verre, transparent, or

H 1100, Ø 110



E27

1x 40W



9 002759 976514

97839 PINTO GOLD

wall light; steel, black / glass, clear, gold
 Wandleuchte; Stahl, schwarz / Glas, klar, gold
 Applique; acier, noir / verre, transparent, or

L 110, H 270, A 150



E27

1x 40W



9 002759 978396



97652



97655



PINTO GOLD



97652 PINTO GOLD

pendant light; steel, black / glass, clear, gold
 Hängeleuchte; Stahl, schwarz / Glas, klar, gold
 luminaire en suspension; acier, noir / verre, transparent, or

L 725, B 110, H 1100



9 002759 976521

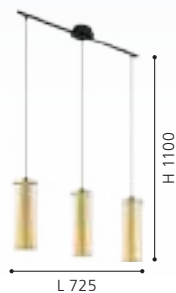

97655 PINTO GOLD

floor light; steel, black, gold / glass, clear, gold
 Stehleuchte; Stahl, schwarz, gold / Glas, klar, gold
 lampadaire; acier, noir, or / verre, transparent, or

H 1470, Ø 110, Base: Ø 230

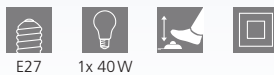

9 002759 976552



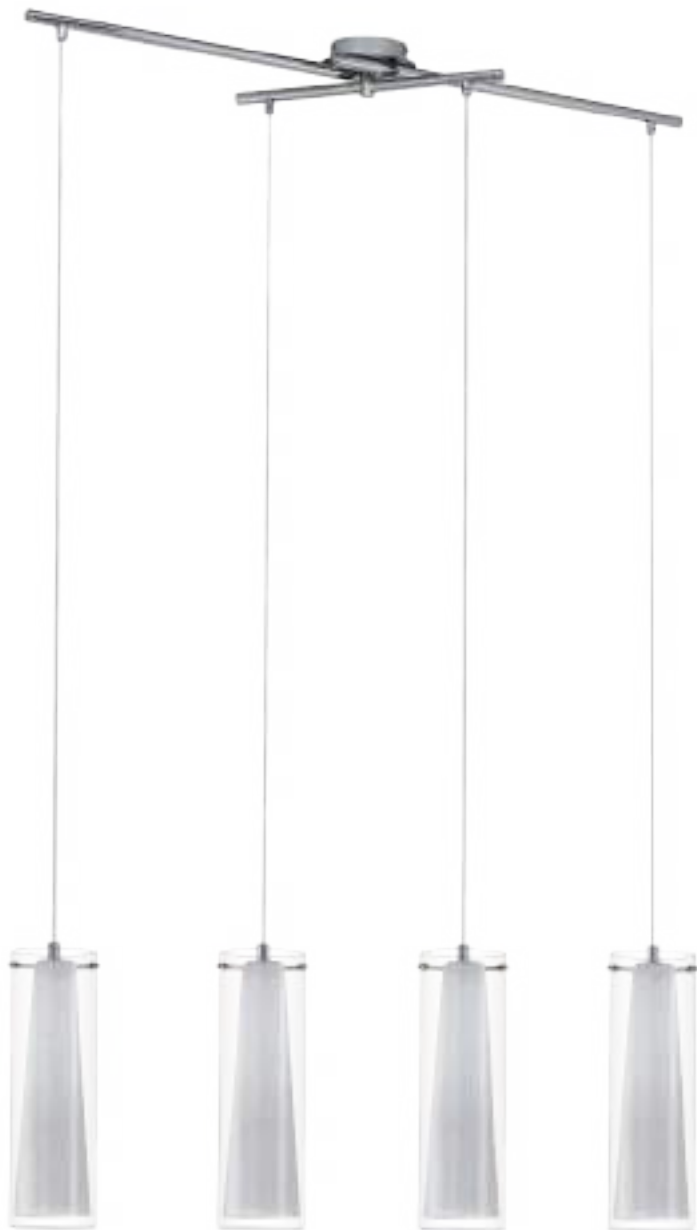

89834



89832 | 89833 | 89834 |
89835 | 89836



89832



89835

89834 PINTO

pendant light; steel, chrome / glass, matte-opal glass, clear, white
Hängeleuchte; Stahl, chrom / Glas, Glas opal-matt, klar, weiss
luminaire en suspension; acier, chrome / verre, verre opale mat, transparent, blanc

L 905, B 360, H 1100



E27 4x 40W



9 002759 898342

89835 PINTO

table light; steel, chrome / glass, matte-opal glass, clear, white
Tischleuchte; Stahl, chrom / Glas, Glas opal-matt, klar, weiss
luminaire de table; acier, chrome / verre, verre opale mat, transparent, blanc

H 500, Ø 110, Base: Ø 155



E27 1x 40W



9 002759 898359

89832 PINTO

pendant light; steel, chrome / glass, matte-opal glass, clear, white
Hängeleuchte; Stahl, chrom / Glas, Glas opal-matt, klar, weiss
luminaire en suspension; acier, chrome / verre, verre opale mat, transparent, blanc

H 1100, Ø 110



E27 1x 40W



9 002759 898328



93003



89833



89836

93003 PINTO

pendant light; steel, chrome / glass, matte-opal glass, clear, white

Hängeleuchte; Stahl, chrom / Glas, Glas opal-matt, klar, weiss
luminaire en suspension; acier, chrome / verre, verre opale mat, transparent, blanc

H 1500, Ø 500



E27 5x 40W



9 002759 930035



89833 PINTO

pendant light; steel, chrome / glass, matte-opal glass, clear, white

Hängeleuchte; Stahl, chrom / Glas, Glas opal-matt, klar, weiss
luminaire en suspension; acier, chrome / verre, verre opale mat, transparent, blanc

L 725, H 1100



E27 3x 40W



9 002759 898335



89836 PINTO

floor light; steel, chrome / glass, matte-opal glass, clear, white

Stehleuchte; Stahl, chrom / Glas, Glas opal-matt, klar, weiss
lampadaire; acier, chrome / verre, verre opale mat, transparent, blanc

H 1470, Ø 110, Base: Ø 230



E27 1x 40W



9 002759 898366

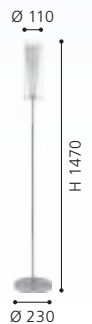



85978



85977

85978 TROY 3

pendant light; steel, satin nickel / satin glass, white painted
 Hängeleuchte; Stahl, nickel-matt / Glas satiniert, weiss lackiert
 luminaire en suspension; acier, nickel mat / verre satiné, blanc laqué

L 720, B 105, H 1100



E27



3x 40W



9 002759 859787



85977 TROY 3

pendant light; steel, satin nickel / satin glass, white painted
 Hängeleuchte; Stahl, nickel-matt / Glas satiniert, weiss lackiert
 luminaire en suspension; acier, nickel mat / verre satiné, blanc laqué

H 1100, Ø 110



E27



1x 40W



9 002759 859770



85979 TROY 3

wall light; steel, satin nickel / satin glass, white
 Wandleuchte; Stahl, nickel-matt / Glas satiniert, weiss
 Applique; acier, nickel mat / verre satiné, blanc laqué

L 180, H 250, A 75



E14



1x 60W



9 002759 859794





85979



85979



85981



85977 | 85978 | 85981 |
85982

85981 TROY 3

table light; steel, satin nickel / satin glass, white painted
Tischleuchte; Stahl, nickel-matt / Glas satiniert, weiss lackiert
luminaire de table; acier, nickel mat / verre satiné, blanc laqué

H 460, Ø 105, Base: Ø 120



E27 1x 40W



9 002759 859817



85982 TROY 3

floor light; steel, satin nickel / satin glass, white painted
Stehleuchte; Stahl, nickel-matt / Glas satiniert, weiss lackiert
lampadaire; acier, nickel mat / verre satiné, blanc laqué

H 1530, Ø 105, Base: Ø 200



E27 1x 40W



9 002759 859824



85982



92741



92742



92743



92742

92741 RIVATO

pendant light; steel, chrome / glass with decoration, white, chrome
 Hängeleuchte; Stahl, chrom / Glas mit Dekor, weiss, chrom
 luminaire en suspension; acier, chrome / verre avec décor, blanc, chrome

L 705, B 90, H 1100

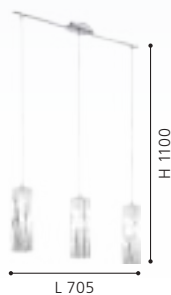

92742 RIVATO

wall light; steel, white, chrome / glass with decoration, white, chrome
 Wandleuchte; Stahl, weiss, chrom / Glas mit Dekor, weiss, chrom
 Applique; acier, blanc, chrome / verre avec décor, blanc, chrome

L 180, H 250, A 80



92743 RIVATO

table light; glass, plastic, white, chrome
 Tischleuchte; Glas, Kunststoff, weiss, chrom
 luminaire de table; verre, plastique, blanc, chrome

H 260, Ø 90

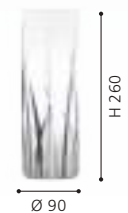



92563



92741 | 92743
91971 | 92563



91971

92563 BAYMAN

pendant light; steel, chrome / glass, white, chrome
Hängeleuchte; Stahl, chrom / Glas, weiss, chrom
luminaire en suspension; acier, chrome / verre, blanc, chrome

L 720, B 105, H 1100

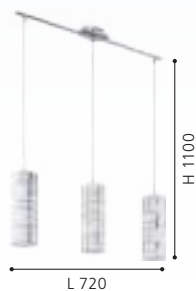
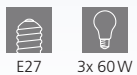

91971 BAYMAN

table light; glass, plastic, white, chrome
Tischleuchte; Glas, Kunststoff, weiss, chrom
luminaire de table; verre, plastique, blanc, chrome

H 270, Ø 105

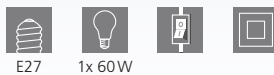



91433



91004

91433 VINOVO

pendant light; steel, dark brown / alabaster glass, white
 Hängeleuchte; Stahl, dunkelbraun / Glas alabaster, weiss
 luminaire en suspension; acier, marron foncé / verre albâtre, blanc

L 770, B 250, H 1100



E27



2x 60W



9 002759 914332



91004 MURCIA

pendant light; steel, black / alabaster glass, white
 Hängeleuchte; Stahl, schwarz / Glas alabaster, weiss
 luminaire en suspension; acier, noir / verre albâtre, blanc

L 680, H 1100



E27



2x 60W



9 002759 910044

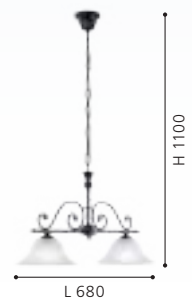



91002



91006



MURCIA, VINOVO

These luminaires come with high quality processed alabaster glass.

Diese Leuchten sind mit hochwertigem Alabasterglas ausgestattet.

Ces luminaires viennent avec un abat-jour en verre d'albâtre haut de gamme.

91002 MURCIA

pendant light; steel, black / alabaster glass, white
Hängeleuchte; Stahl, schwarz / Glas alabaster, weiss
luminaire en suspension; acier, noir / verre albâtre, blanc

H 1100, Ø 380

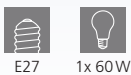

9 002759 910020

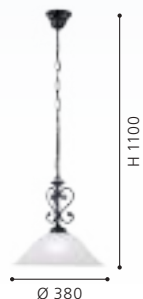

91006 MURCIA

wall light; steel, black / alabaster glass, white
Wandleuchte; Stahl, schwarz / Glas alabaster, weiss
Applique; acier, noir / verre albâtre, blanc

L 165, H 190, A 230



9 002759 910068





82748



82749



DESIGN
HIGHLIGHT
DETAIL

82748 SAVOY

pendant light; cast metal, bronzed / satin glass, white
Hängeleuchte; Metallguss, brüniert / Glas satiniert, weiss
luminaire en suspension; fonte métallique, brun / verre satiné, blanc

H 1100, Ø 740

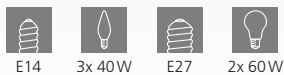

9 002759 827489



82749 SAVOY

pendant light; cast metal, bronzed / satin glass, white
Hängeleuchte; Metallguss, brüniert / Glas satiniert, weiss
luminaire en suspension; fonte métallique, brun / verre satiné, blanc

H 1100, Ø 740



9 002759 827496





82751



82752



82747



82751 SAVOY

wall light; cast metal, bronzed / satin glass, white
Wandleuchte; Metallguss, brüniert / Glas satiniert, weiss
Applique; fonte métallique, brun / verre satiné, blanc

L 180, H 160, A 240



E14 1x 40W



9 002759 827519



82752 SAVOY

wall light; cast metal, bronzed / satin glass, white
Wandleuchte; Metallguss, brüniert / Glas satiniert, weiss
Applique; fonte métallique, brun / verre satiné, blanc

L 410, H 160, A 210



E14 2x 40W



9 002759 827526

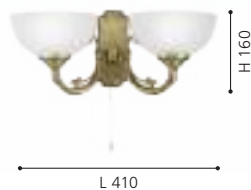

82747 SAVOY

pendant light; cast metal, bronzed / satin glass, white
Hängeleuchte; Metallguss, brüniert / Glas satiniert, weiss
luminaire en suspension; fonte métallique, brun / verre satiné, blanc

H 1100, Ø 310



E27 2x 60W



9 002759 827472

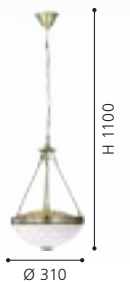



85856



85857



85859

85856 MARBELLA

ceiling light; cast metal, bronzed / alabaster glass, champagne
Deckenleuchte; Metallguss, brüniert / Glas alabaster, champagner
plafonnier; fonte métallique, brun / verre albâtre, champagne

H 410, Ø 370



E14 3x 60W



9 002759 858568

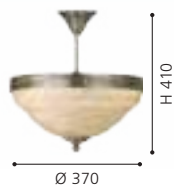

85857 MARBELLA

pendant light; cast metal, bronzed / alabaster glass, champagne
Hängeleuchte; Metallguss, brüniert / Glas alabaster, champagner
luminaire en suspension; fonte métallique, brun / verre albâtre, champagne

H 1100, Ø 740

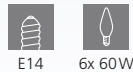

E14 6x 60W



9 002759 858575



85859 MARBELLA

wall light; cast metal, bronzed / alabaster glass, champagne
Wandleuchte; Metallguss, brüniert / Glas alabaster, champagner
applique; fonte métallique, brun / verre albâtre, champagne

L 170, H 200, A 230



E14 1x 40W



9 002759 858599





85858

85858 MARBELLA

pendant light; cast metal, bronzed / alabaster glass, champagne
 Hängeleuchte; Metallguss, brüniert / Glas alabaster, champagner
 luminaire en suspension; fonte métallique, brun / verre albâtre, champagne

H 1100, Ø 740



MARBELLA

These luminaires come with high quality processed alabaster glass.

Diese Leuchten sind mit hochwertigem Alabasterglas ausgestattet.

Ces luminaires viennent avec un abat-jour en verre d'albâtre haut de gamme.



98874



98875



98876



98876 ERVIDEL

pendant light; steel, black / plastic, satin finish
Hängeleuchte; Stahl, schwarz / Kunststoff, satiniert
luminaire en suspension; acier, noir / plastique, satiné

L 930, B 60, H 1100



6x 4,5W 2880lm



9 002759 988760

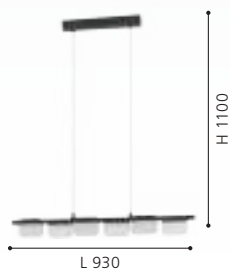

98874 ERVIDEL

ceiling light; steel, black / plastic, satin finish
Deckenleuchte; Stahl, schwarz / Kunststoff, satiniert
plafonnier; acier, noir / plastique, satiné

L 625, B 60, H 160



4x 4,5W 1920lm



9 002759 988746



98875 ERVIDEL

ceiling light; steel, black / plastic, satin finish
Deckenleuchte; Stahl, schwarz / Kunststoff, satiniert
plafonnier; acier, noir / plastique, satiné

L 930, B 60, H 160



6x 4,5W 2880lm



9 002759 988753





98878

LED



98877

LED

98878 ERVIDEL

table light; steel, black / plastic, satin finish
Tischleuchte; Stahl, schwarz / Kunststoff, satiniert
luminaire de table; acier, noir / plastique, satiné

L 155, B 60, H 500, Base: B 180, T 180



2x 4,5W 960lm



9 002759 988784



98877 ERVIDEL

wall light; steel, black / plastic, satin finish
Wandleuchte; Stahl, schwarz / Kunststoff, satiniert
Applique; acier, noir / plastique, satiné

L 320, H 90, A 80



2x 4,5W 960lm



9 002759 988777





900351



900352



900351 CLAVELLINA

ceiling light; steel, black / plastic, white
Deckenleuchte; Stahl, schwarz / Kunststoff, weiss
plafonnier; acier, noir / plastique, blanc

L 890, B 465, H 185



4x 6,8W 3200lm



9 008606 241088



900352 CLAVELLINA

pendant light; steel, black / plastic, white
Hängeleuchte; Stahl, schwarz / Kunststoff, weiss
luminaire en suspension; acier, noir / plastique, blanc

L 1200, B 400, H 1100



6x 7W 4800lm



9 008606 241095



900353 CLAVELLINA

table light; steel, black / plastic, white
Tischleuchte; Stahl, schwarz / Kunststoff, weiss
luminaire de table; acier, noir / plastique, blanc

L 550, H 450, Base: Ø 180



1x 6,8W 800lm



9 008606 241101

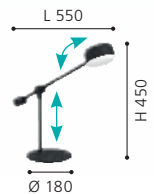



900353



900354 CLAVELLINA

floor light; steel, black / plastic, white
 Stehleuchte; Stahl, schwarz / Kunststoff, weiss
 lampadaire; acier, noir / plastique, blanc

L 1215, H 1605, Base: Ø 300

LED

24W

warm
 WHITE

2210lm

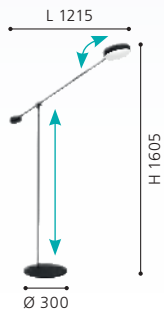

9 008606 243518



900354





99562

LED



DESIGN
HIGHLIGHT
DETAIL

99562 ISIDRO

pendant light; aluminium, steel, black / plastic, satin finish
Hängeleuchte; Alu, Stahl, schwarz / Kunststoff, satiniert
luminaire en suspension; aluminium, acier, noir / plastique, satiné

L 795, B 60, H 1100

LED
27W

warm
WHITE
3850lm



9 002759 995621





99561



99563



99564



99561 ISIDRO

ceiling light; aluminium, steel, black / plastic, satin finish
Deckenleuchte; Alu, Stahl, schwarz / Kunststoff, satiniert
plafonnier; aluminium, acier, noir / plastique, satiné

L 860, B 80, H 110



2x 11 W 2700lm



9 002759 995614



99563 ISIDRO

wall light; aluminium, steel, black / plastic, satin finish
Wandleuchte; Alu, Stahl, schwarz / Kunststoff, satiniert
Applique; aluminium, acier, noir / plastique, satiné

L 395, H 80, A 70



9 W 1050lm



9 002759 995638



99564 ISIDRO

table light; aluminium, steel, black / plastic, satin finish
Tischleuchte; Alu, Stahl, schwarz / Kunststoff, satiniert
luminaire de table; aluminium, acier, noir / plastique, satiné

L 70, B 15, H 410, Base: B 150, T 130



9 W 1050lm



9 002759 995645





900563

LED



CARANACOA

These luminaires have swiveling light rings.
 Diese Leuchten verfügen über schwenkbare Leuchtringe.
 Ces luminaires ont des anneaux lumineux pivotants.

900563 CARANACOA

pendant light; steel, black / plastic, white
 Hängeleuchte; Stahl, schwarz / Kunststoff, weiss
 luminaire en suspension; acier, noir / plastique, blanc

L 1170, B 230, H 1100

LED

5x 7 W

warm
 WHITE

7000lm

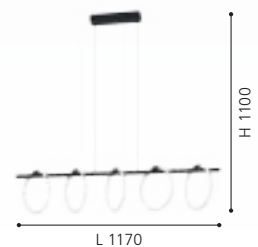



900562

LED



900564

LED



900565

LED

900562 CARANACOA

pendant light; steel, black / plastic, white
Hängeleuchte; Stahl, schwarz / Kunststoff, weiss
luminaire en suspension; acier, noir / plastique, blanc

L 780, B 230, H 1100



3x 9W 3600lm



9 008606 244645



900564 CARANACOA

wall light; steel, black / plastic, white
Wandleuchte; Stahl, schwarz / Kunststoff, weiss
Applique; acier, noir / plastique, blanc

L 260, H 260, A 45



11,5W 1500lm



9 008606 244669



900565 CARANACOA

table light; steel, black / plastic, white
Tischleuchte; Stahl, schwarz / Kunststoff, weiss
luminaire de table; acier, noir / plastique, blanc

L 260, B 50, H 260, Base: Ø 100



11,5W 1500lm



9 008606 244676





900917

LED



900916

LED

900917 VALLEROSA

pendant light; aluminium, steel, brushed brass / plastic, white
 Hängeleuchte; Alu, Stahl, messing-gebürstet / Kunststoff, weiss
 luminaire en suspension; aluminium, acier, laiton brossé /
 plastique, blanc

H 1100, Ø 580

LED

25,2 W

warm
WHITE

3000 lm



9 008606 277827





900918

LED



900919

LED



900916 VALLEROSA

ceiling light; aluminium, steel, brushed brass / plastic, white
Deckenleuchte; Alu, Stahl, messing-gebürstet / Kunststoff, weiss
plafonnier; aluminium, acier, laiton brossé / plastique, blanc

L 580, B 335, H 75



25,2W 3000lm



9 008606 277810



900918 VALLEROSA

table light; aluminium, steel, brushed brass / plastic, white
Tischleuchte; Alu, Stahl, messing-gebürstet / Kunststoff, weiss
luminaire de table; aluminium, acier, laiton brossé / plastique, blanc

L 220, H 425, Base: Ø 130



10,8W 1300lm



9 008606 277834



900919 VALLEROSA

floor light; aluminium, steel, brushed brass / plastic, white
Stehleuchte; Alu, Stahl, messing-gebürstet / Kunststoff, weiss
lampadaire; aluminium, acier, laiton brossé / plastique, blanc

L 290, H 1285, Base: Ø 200



25,2W 3400lm



9 008606 277841





99358



900631



900632



99358 CODRIALES

pendant light; steel, black / plastic, white
 Hängeleuchte; Stahl, schwarz / Kunststoff, weiss
 luminaire en suspension; acier, noir / plastique, blanc

L 780, B 300, H 1100



27W 4000lm



9 002759 993580



900631 CODRIALES

ceiling light; aluminium, black / plastic, white
 Deckenleuchte; Alu, schwarz / Kunststoff, weiss
 plafonnier; aluminium, noir / plastique, blanc

L 790, B 300, H 116



27W 4000lm



9 008606 241040



900632 CODRIALES

wall light; aluminium, black / plastic, white
 Wandleuchte; Alu, schwarz / Kunststoff, weiss
 Applique; aluminium, noir / plastique, blanc

L 180, H 320, A 65



10,8W 1400lm



9 008606 241057





900633



900633 CODRIALES

table light; aluminium, black / plastic, white

Tischleuchte; Alu, schwarz / Kunststoff, weiss

luminaire de table; aluminium, noir / plastique, blanc

L 205, B 80, H 380



10,8W



1500lm



9 008606 241064

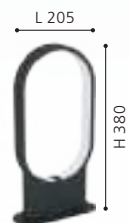



900948

LED



900951

LED

900948 GIANELLA

pendant light; aluminium, steel, black / plastic, white
 Hängeleuchte; Alu, Stahl, schwarz / Kunststoff, weiss
 luminaire en suspension; aluminium, acier, noir / plastique, blanc

L 1150, B 375, H 1100

LED warm WHITE

36W 3960lm



9 008606 275014

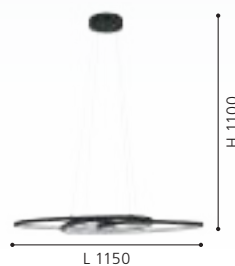

900951 GIANELLA

table light; aluminium, steel, black / plastic, white
 Tischleuchte; Alu, Stahl, schwarz / Kunststoff, weiss
 luminaire de table; aluminium, acier, noir / plastique, blanc

L 220, B 130, H 400, Base: Ø 130

LED warm WHITE

12W 1100lm



9 008606 275038

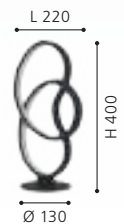



900947



900949



901015



900947 GIANELLA

ceiling light; aluminium, steel, black / plastic, white
Deckenleuchte; Alu, Stahl, schwarz / Kunststoff, weiss
plafonnier; aluminium, acier, noir / plastique, blanc

L 880, B 335, H 210



36W 3960lm



9 008606 275007



900949 GIANELLA

wall light; aluminium, steel, black / plastic, white
Wandleuchte; Alu, Stahl, schwarz / Kunststoff, weiss
Applique; aluminium, acier, noir / plastique, blanc

L 365, B 240, A 100



12W 1100lm



9 008606 275021



901015 GIANELLA

floor light; aluminium, steel, black / plastic, white
Stehleuchte; Alu, Stahl, schwarz / Kunststoff, weiss
lampadaire; aluminium, acier, noir / plastique, blanc

L 250, B 300, H 1025, Base: Ø 250



40W 3700lm



9 008606 291489

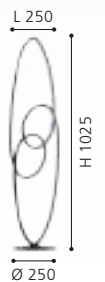



900465



900466



900465 SIBERIA

ceiling light; steel, black / plastic, white
 Deckenleuchte; Stahl, schwarz / Kunststoff, weiss
 plafonnier; acier, noir / plastique, blanc

L 780, B 160, H 235



9 008606 244041

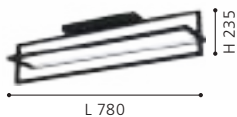

900466 SIBERIA

pendant light; steel, black / plastic, white
 Hängeleuchte; Stahl, schwarz / Kunststoff, weiss
 luminaire en suspension; acier, noir / plastique, blanc

L 780, B 160, H 1100



9 008606 244058

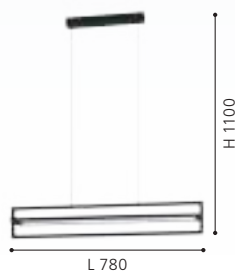

900467 SIBERIA

wall light; steel, black / plastic, white
 Wandleuchte; Stahl, schwarz / Kunststoff, weiss
 Applique; acier, noir / plastique, blanc

L 160, H 300, A 190



9 008606 244065





900467



incl./inkl./inclus



900468



incl./inkl./inclus



900469



incl./inkl./inclus

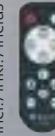

900468 SIBERIA

table light; steel, black / plastic, white
Tischleuchte; Stahl, schwarz / Kunststoff, weiss
luminaire de table; acier, noir / plastique, blanc

L 160, B 160, H 430, Base: B 160, T 160



15,5W 2200lm



9 008606 244072



900469 SIBERIA

floor light; steel, black / plastic, white
Stehleuchte; Stahl, schwarz / Kunststoff, weiss
lampadaire; acier, noir / plastique, blanc

L 200, B 160, H 1330, Base: B 200, T 160



34W 4600lm



9 008606 244089

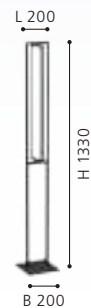



99799

LED



99801

LED



99802

LED

99799 LEJIAS

ceiling light; steel, black / plastic, transparent
 Deckenleuchte; Stahl, schwarz / Kunststoff, transparent
 plafonnier; acier, noir / plastique, transparent

L 450, B 450, H 75



21W

3050lm

99801 LEJIAS

ceiling light; steel, black / plastic, transparent
 Deckenleuchte; Stahl, schwarz / Kunststoff, transparent
 plafonnier; acier, noir / plastique, transparent

L 780, B 80



21,5W

2600lm

99802 LEJIAS

pendant light; steel, black / plastic, transparent
 Hängeleuchte; Stahl, schwarz / Kunststoff, transparent
 luminaire en suspension; acier, noir / plastique, transparent

L 780, B 80, H 1750



21,5W

2600lm



9 002759 997991



9 002759 998011



9 002759 998028





99803



99804



99805



99803 LEJIAS

wall light; steel, black / plastic, transparent
Wandleuchte; Stahl, schwarz / Kunststoff, transparent
Applique; acier, noir / plastique, transparent

L 90, H 285



8W 1050lm



9 002759 998035



99804 LEJIAS

table light; steel, black / plastic, transparent
Tischleuchte; Stahl, schwarz / Kunststoff, transparent
luminaire de table; acier, noir / plastique, transparent

H 330, Base: B 140, T 140



8W 900lm



9 002759 998042



99805 LEJIAS

floor light; steel, black / plastic, transparent
Stehleuchte; Stahl, schwarz / Kunststoff, transparent
lampadaire; acier, noir / plastique, transparent

H 1230, Base: B 230, T 230



16W 2050lm



9 002759 998059



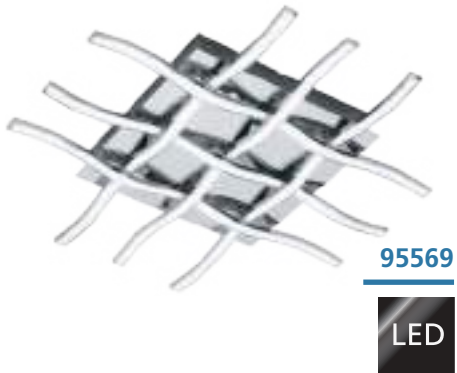

95569

LED



96104

LED



96102

LED

95569 LASANA 1

wall/ceiling light; steel, chrome / plastic, white
Wand- / Deckenleuchte; Stahl, chrom / Kunststoff, weiss
Applique/Plafonnier; acier, chrome / plastique, blanc

L 500, B 500, H 65

LED

warm
WHITE



6x 6W 4860lm



9 002759 955694

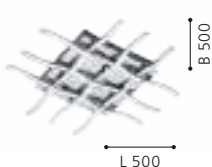

L 500

96104 LASANA 2

pendant light; steel, aluminium, chrome / plastic, white
Hängeleuchte; Stahl, Alu, chrom / Kunststoff, weiss
luminaire en suspension; acier, aluminium, chrome / plastique, blanc

L 1200, B 80, H 1200

LED

warm
WHITE



2x 13W 3400lm



9 002759 961046

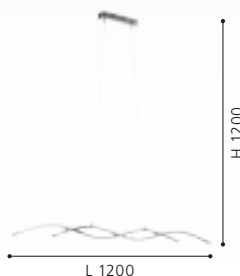

L 1200

96102 LASANA 2

pendant light; steel, aluminium, chrome / plastic, white
Hängeleuchte; Stahl, Alu, chrom / Kunststoff, weiss
luminaire en suspension; acier, aluminium, chrome / plastique, blanc

L 1000, B 80, H 1200

LED

warm
WHITE



35W 5300lm



9 002759 961022

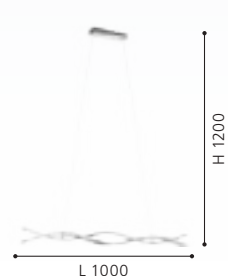

L 1000

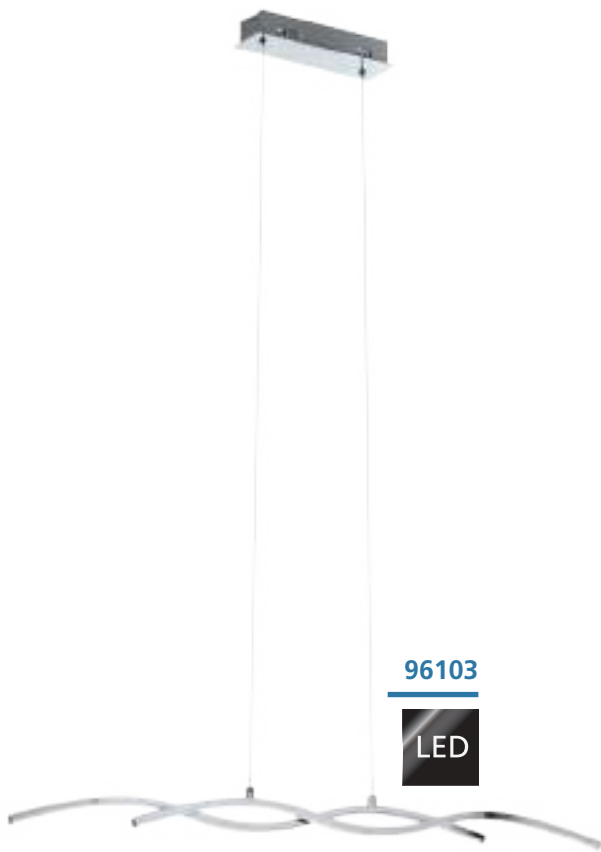

96103



96105



96106



96103 LASANA 2

pendant light; steel, aluminium, chrome / plastic, white
 Hängeleuchte; Stahl, Alu, chrom / Kunststoff, weiss
 luminaire en suspension; acier, aluminium, chrome / plastique, blanc

L 870, B 80, H 1200



19W 2600lm



9 002759 961039

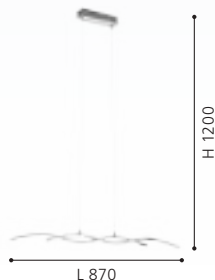

96105 LASANA 2

table light; steel, aluminium, chrome / plastic, white
 Tischleuchte; Stahl, Alu, chrom / Kunststoff, weiss
 luminaire de table; acier, aluminium, chrome / plastique, blanc

L 160, B 100, H 460



2x 5,5W 1440lm



9 002759 961053



96106 LASANA 2

floor light; steel, aluminium, chrome / plastic, white
 Stehleuchte; Stahl, Alu, chrom / Kunststoff, weiss
 lampadaire; acier, aluminium, chrome / plastique, blanc

L 250, B 130, H 1420



36W 4700lm



9 002759 961060



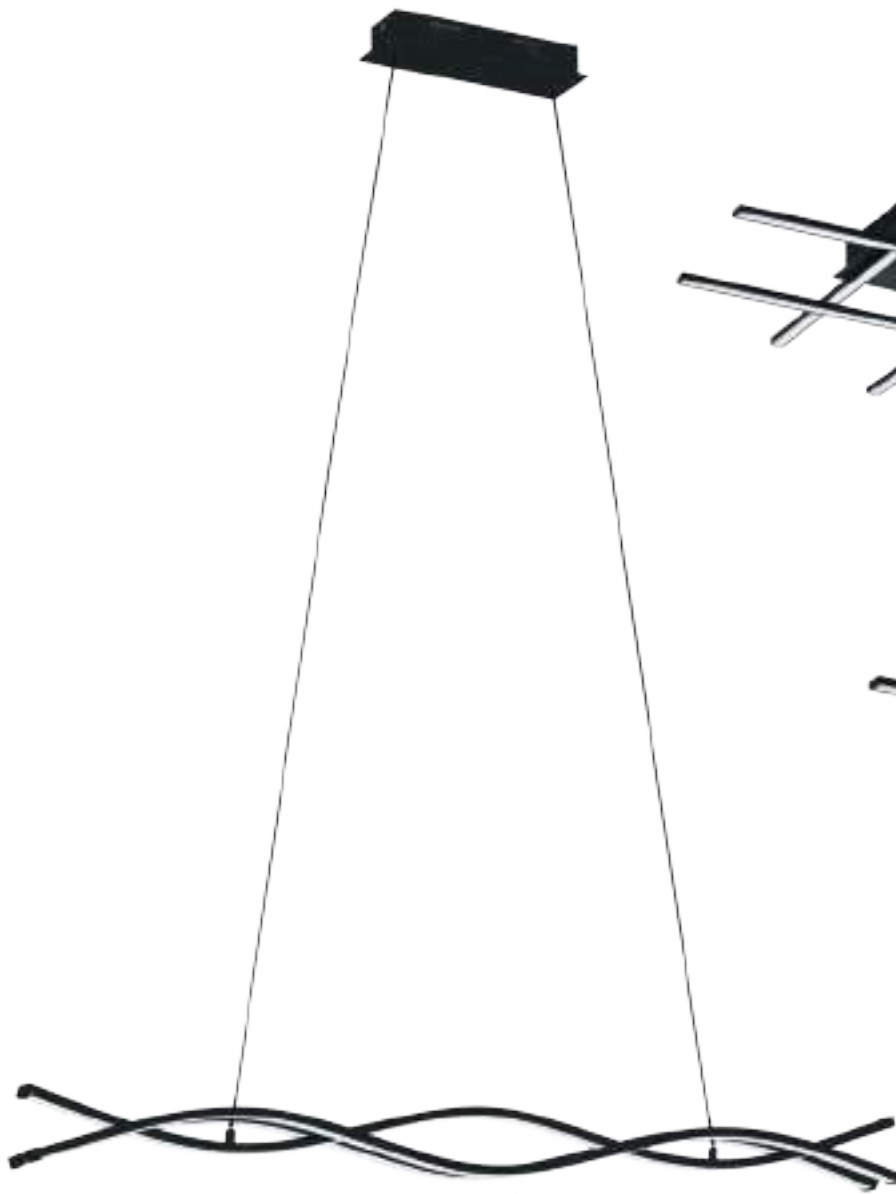

99317



99316



99315



99317 LASANA 3

pendant light; steel, aluminium, black / plastic, white
 Hängeleuchte; Stahl, Alu, schwarz / Kunststoff, weiss
 luminaire en suspension; acier, aluminium, noir / plastique, blanc

L 985, B 80, H 1200



33W 4500lm



9 002759 993177

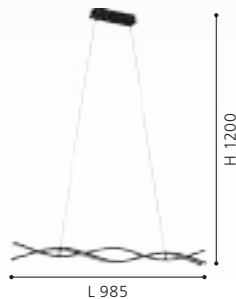

99316 LASANA 3

wall/ceiling light; steel, aluminium, black / plastic, white
 Wand- / Deckenleuchte; Stahl, Alu, schwarz / Kunststoff, weiss
 Applique/Plafonnier; acier, aluminium, noir / plastique, blanc

L 500, B 500, H 95



4x 5,3W 2800lm



9 002759 993160



99315 LASANA 3

wall/ceiling light; steel, aluminium, black / plastic, white
 Wand- / Deckenleuchte; Stahl, Alu, schwarz / Kunststoff, weiss
 Applique/Plafonnier; acier, aluminium, noir / plastique, blanc

L 500, B 145, H 90



3x 3,5W 1500lm



9 002759 993153





99319

LED



99318

LED

99319 LASANA 3

floor light; steel, aluminium, black / plastic, white
 Stehleuchte; Stahl, Alu, schwarz / Kunststoff, weiss
 lampadaire; acier, aluminium, noir / plastique, blanc

L 250, B 130, H 1420, Base: B 230, T 150



36W 4700lm



9 002759 993191



99318 LASANA 3

table light; steel, aluminium, black / plastic, white
 Tischleuchte; Stahl, Alu, schwarz / Kunststoff, weiss
 luminaire de table; acier, aluminium, noir / plastique, blanc

L 160, B 100, H 460, Base: B 180, T 100



11,5W 1280lm



9 002759 993184





95147

LED



32048

LED

95147 LASANA

pendant light; aluminium, steel, chrome / plastic, white
 Hängeleuchte; Alu, Stahl, chrom / Kunststoff, weiss
 luminaire en suspension; aluminium, acier, chrome / plastique, blanc

L 900, H 1100

LED

30W

warm
WHITE

3500lm



9 002759 951474

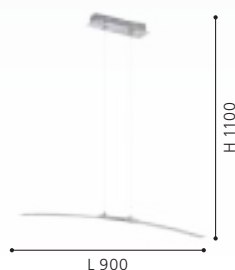

32048 LASANA

pendant light; aluminium, steel, chrome / plastic, white
 Hängeleuchte; Alu, Stahl, chrom / Kunststoff, weiss
 luminaire en suspension; aluminium, acier, chrome / plastique, blanc

L 900, H 1000

LED

15W

warm
WHITE

1800lm



9 002759 320485

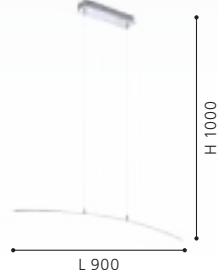



95568

LED



95567

LED



96866

LED

95568 LASANA 1

wall/ceiling light; steel, chrome / plastic, white
Wand- / Deckenleuchte; Stahl, chrom / Kunststoff, weiss
Applique/Plafonnier; acier, chrome / plastique, blanc

L 500, B 500, H 95



4x 5,3W 2800lm



9 002759 955687

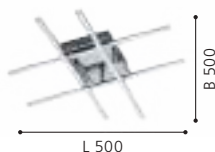

95567 LASANA 1

wall/ceiling light; steel, chrome / plastic, white
Wand- / Deckenleuchte; Stahl, chrom / Kunststoff, weiss
Applique/Plafonnier; acier, chrome / plastique, blanc

L 500, B 160, H 95



3x 3,5W 1500lm



9 002759 955670

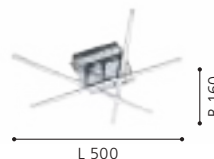

96866 TARANDELL

pendant light; aluminium, steel, chrome / plastic, satin finish
Hängeleuchte; Alu, Stahl, chrom / Kunststoff, satiniert
luminaire en suspension; aluminium, acier, chrome / plastique, satiné

L 1180, B 60, H 930 - 1620



2x 12,5W 3300lm



9 002759 968663

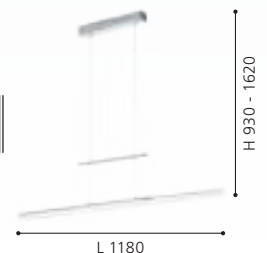



99322

LED



99321

LED



99323

LED

99322 RONCADE 1

wall/ceiling light; steel, aluminium, black / plastic, white
Wand- / Deckenleuchte; Stahl, Alu, schwarz / Kunststoff, weiss
Applique/Plafonnier; acier, aluminium, noir / plastique, blanc

L 1160, B 180, H 115



36W 4600lm

99321 RONCADE 1

wall/ceiling light; steel, aluminium, black / plastic, white
Wand- / Deckenleuchte; Stahl, Alu, schwarz / Kunststoff, weiss
Applique/Plafonnier; acier, aluminium, noir / plastique, blanc

L 650, B 130, H 45



21W 2800lm

99323 SELVINA 1

ceiling light; steel, aluminium, black / plastic, white
Deckenleuchte; Stahl, Alu, schwarz / Kunststoff, weiss
plafonnier; acier, aluminium, noir / plastique, blanc

L 690, B 300, H 115



19W 2700lm



9 002759 993221

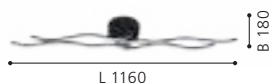

9 002759 993214



9 002759 993238





31996



31995



96329



31996 RONCADE

wall/ceiling light; aluminium, steel, chrome / plastic, white
Wand- / Deckenleuchte; Alu, Stahl, chrom / Kunststoff, weiss
Applique/Plafonnier; aluminium, acier, chrome / plastique, blanc

L 1085, B 160, H 125

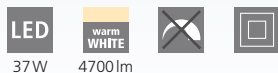

37W 4700lm



9 002759 319960



31995 RONCADE

wall/ceiling light; aluminium, steel, chrome / plastic, white
Wand- / Deckenleuchte; Alu, Stahl, chrom / Kunststoff, weiss
Applique/Plafonnier; aluminium, acier, chrome / plastique, blanc

L 650, B 130, H 45



21W 2800lm



9 002759 319953



96329 SELVINA

ceiling light; aluminium, chrome / plastic, white
Deckenleuchte; Alu, chrom / Kunststoff, weiss
plafonnier; aluminium, chrome / plastique, blanc

L 690, B 300, H 115



19W 2700lm



9 002759 963293





96308

LED

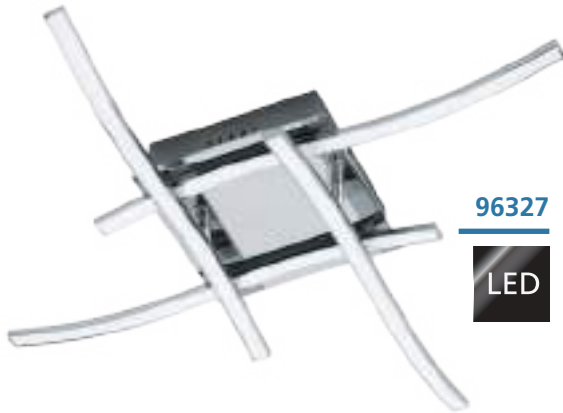

96327

LED



96326

LED

96308 SELVINA

ceiling light; aluminium, chrome / plastic, white
Deckenleuchte; Alu, chrom / Kunststoff, weiss
plafonnier; aluminium, chrome / plastique, blanc

L 745, B 175, H 85

LED

warm
WHITE
2900lm



9 002759 963088



96327 VALMORA

ceiling light; aluminium, chrome / plastic, white
Deckenleuchte; Alu, chrom / Kunststoff, weiss
plafonnier; aluminium, chrome / plastique, blanc

L 560, B 560, H 105

LED

warm
WHITE
2450lm



9 002759 963279

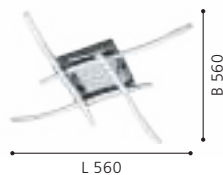

96326 VALMORA

ceiling light; aluminium, chrome / plastic, white
Deckenleuchte; Alu, chrom / Kunststoff, weiss
plafonnier; aluminium, chrome / plastique, blanc

L 590, B 125, H 90

LED

warm
WHITE
1700lm



9 002759 963262





96332

LED



96305

LED

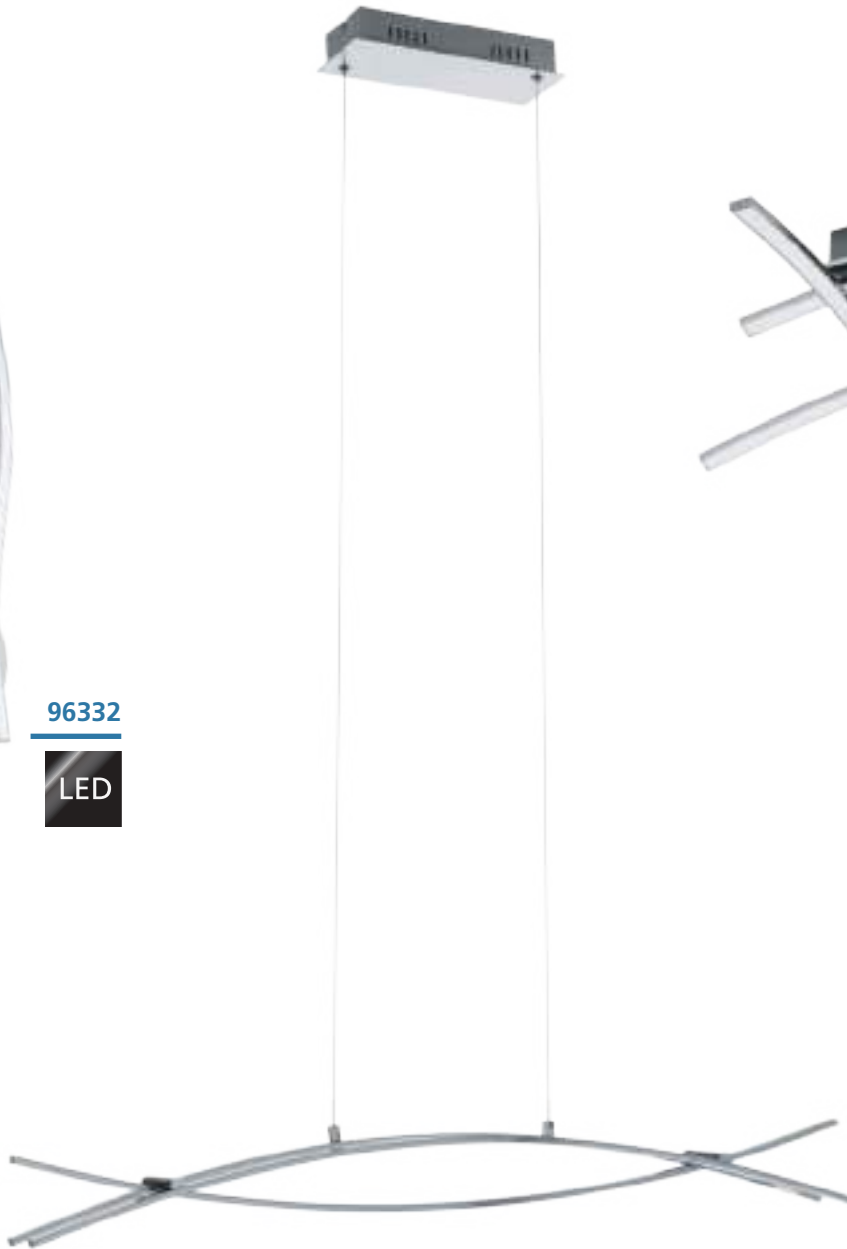

96331

LED

96332 VALMORA

wall light; aluminium, chrome / plastic, white
Wandleuchte; Alu, chrom / Kunststoff, weiss
Applique; aluminium, chrome / plastique, blanc

L 115, H 450, A 90



9W 1250lm



9 002759 963323



96331 NEVADO

pendant light; aluminium, chrome / plastic, white
Hängeleuchte; Alu, chrom / Kunststoff, weiss
luminaire en suspension; aluminium, chrome / plastique, blanc

L 900, B 80, H 1100



23,6W 3400lm



9 002759 963316

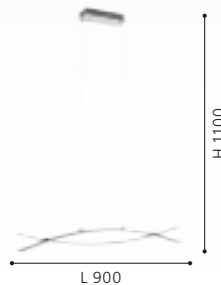

96305 NEVADO

ceiling light; aluminium, chrome / plastic, white
Deckenleuchte; Alu, chrom / Kunststoff, weiss
plafonnier; aluminium, chrome / plastique, blanc

L 500, B 500, H 115



18W 2450lm



9 002759 963057

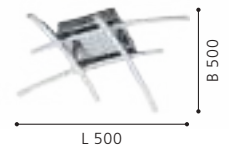



31997

LED



98889

LED



99559

LED

31997 RONCADE

table light; aluminium, steel, chrome / plastic, white
Tischleuchte; Alu, Stahl, chrom / Kunststoff, weiss
luminaire de table; aluminium, acier, chrome / plastique, blanc

L 195, B 150, H 335

LED

warm
WHITE



8,8W

866lm

98889 PALOZZA 1

wall light; aluminium, satin nickel / plastic, white
Wandleuchte; Alu, nickel-matt / Kunststoff, weiss
Applique; aluminium, nickel mat / plastique, blanc

L 170, H 425, A 60

LED

warm
WHITE



10W

1300lm

99559 PALOZZA 1

table light; aluminium, satin nickel / plastic, white
Tischleuchte; Alu, nickel-matt / Kunststoff, weiss
luminaire de table; aluminium, nickel mat / plastique, blanc

L 150, B 110, H 420

LED

warm
WHITE



11W

1400lm



9 002759 319977

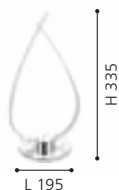

L 195

H 335



9 002759 988890



L 170

H 425



9 002759 995591



L 150

H 420



96306

LED



97361

LED

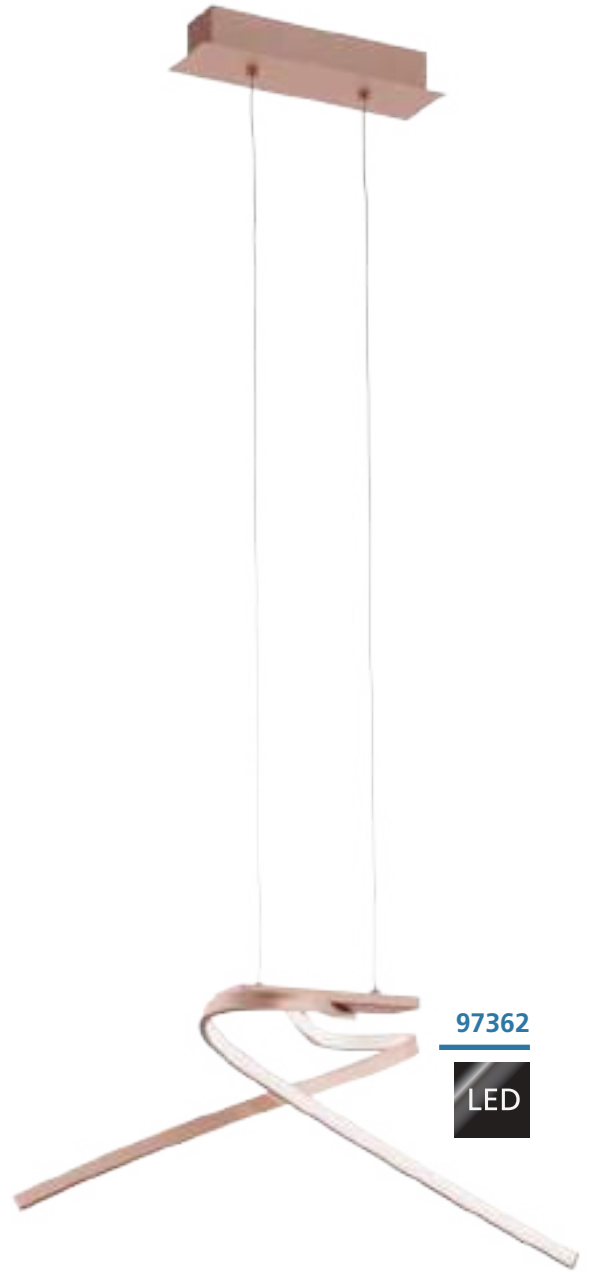

97362

LED

96306 SELVINA

ceiling light; aluminium, chrome / plastic, white
Deckenleuchte; Alu, chrom / Kunststoff, weiss
plafonnier; aluminium, chrome / plastique, blanc

L 460, B 390, H 380



28W 3600lm



9 002759 963064

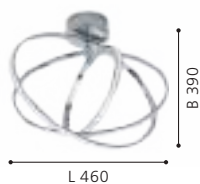

97361 PALOZZA

ceiling light; aluminium, rose gold / plastic, white
Deckenleuchte; Alu, roségold / Kunststoff, weiss
plafonnier; aluminium, rose or / plastique, blanc

L 705, B 315, H 125



19W 2700lm



9 002759 973612

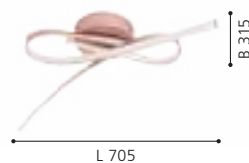

97362 PALOZZA

pendant light; aluminium, rose gold / plastic, white
Hängeleuchte; Alu, roségold / Kunststoff, weiss
luminaire en suspension; aluminium, rose or / plastique, blanc

L 705, B 315, H 1100



19W 2600lm



9 002759 973629

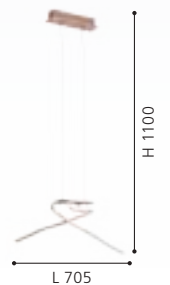



LIGHTING FAMILIES / GLASS CHANDELIERS

LEUCHTENFAMILIEN / GLASLUSTER
FAMILLES DE LUMINAIRES / LUSTRES EN VERRE



EN SPARKLING

Extravagant lighting – our glass chandeliers will give you light in a new diversity while ensuring an extraordinary ambience. Our chandeliers are true jewels on your ceiling and spread their elegance in your entire living area.

DE FUNKELN

Beleuchtung der Extravaganz – Mit unseren Glaslustern erleben Sie Licht in neuer Vielfalt und sorgen für ein außergewöhnliches Ambiente. Unsere Kronleuchter werden zum wahren Schmuckstück und bringen Eleganz in all Ihre Wohnbereiche.

FR DU SCINTILLEMENT

Un éclairage riche en extravagance – Avec nos lustres en verre, vous faites l'expérience de la lumière dans une nouvelle multiplicité et vous assurez une ambiance extraordinaire. Nos plafonniers lustres en deviennent de vrais bijoux et prêtent de l'élégance à tous vos espaces d'habitat.





OVERVIEW

LIGHTING FAMILIES / GLAS CHANDELIERS
LEUCHTENFAMILIEN / GLASLUSTER
FAMILLES DE LUMINAIRES / LUSTRES EN VERRE



BASILANO 1
340-341



BASILANO
342-343



CARPENTIO
344



This product is available in different colors and shapes. / Dieser Artikel ist in unterschiedlichen Farben und Formen verfügbar. /
Cet article est disponible en différentes couleurs et formes.





39103



39101

39103 BASILANO 1

pendant light; steel, chrome / glass, clear
 Hängeleuchte; Stahl, chrom / Glas, klar
 luminaire en suspension; acier, chrome / verre, transparent

H 1500, Ø 1000



E14 18x 40W



9 002759 391034

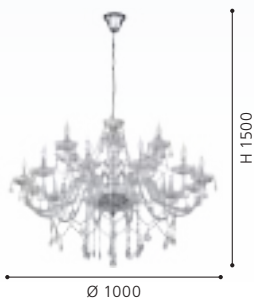

39101 BASILANO 1

pendant light; steel, chrome / glass, clear
 Hängeleuchte; Stahl, chrom / Glas, klar
 luminaire en suspension; acier, chrome / verre, transparent

H 1300, Ø 820



E14 8x 40W



9 002759 391010



39099 BASILANO 1

pendant light; steel, chrome / glass, clear
 Hängeleuchte; Stahl, chrom / Glas, klar
 luminaire en suspension; acier, chrome / verre, transparent

H 1300, Ø 720



E14 6x 40W



9 002759 390990

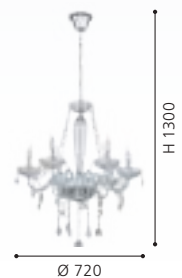



39099



39102

39102 BASILANO 1

pendant light; steel, chrome / glass, clear

Hängeleuchte; Stahl, chrom / Glas, klar

luminaire en suspension; acier, chrome / verre, transparent

H 1500, Ø 1000



E14



12x 40W



9 002759 391027



H 1500

Ø 1000



39095



39092

39095 BASILANO

pendant light; steel, chrome / glass, cognac
 Hängeleuchte; Stahl, chrom / Glas, cognac
 luminaire en suspension; acier, chrome / verre, cognac

H 1500, Ø 1000



E14 18x 40W



9 002759 390952



39092 BASILANO

pendant light; steel, chrome / glass, cognac
 Hängeleuchte; Stahl, chrom / Glas, cognac
 luminaire en suspension; acier, chrome / verre, cognac

H 1300, Ø 720



E14 6x 40W



9 002759 390921





39093



39094

39093 BASILANO

pendant light; steel, chrome / glass, cognac
 Hängeleuchte; Stahl, chrom / Glas, cognac
 luminaire en suspension; acier, chrome / verre, cognac

H 1300, Ø 820



9 002759 390938



39094 BASILANO

pendant light; steel, chrome / glass, cognac
 Hängeleuchte; Stahl, chrom / Glas, cognac
 luminaire en suspension; acier, chrome / verre, cognac

H 1500, Ø 1000



9 002759 390945





39113

39113 CARPENTO

pendant light; steel, chrome / glass, white
 Hängeleuchte; Stahl, chrom / Glas, weiss
 luminaire en suspension; acier, chrome / verre, blanc

H 1200, Ø 590



E14 5x 40W



9 002759 391133



39114 CARPENTO

pendant light; steel, chrome / glass, white
 Hängeleuchte; Stahl, chrom / Glas, weiss
 luminaire en suspension; acier, chrome / verre, blanc

H 1300, Ø 700



E14 8x 40W



9 002759 391140



39114





HANGING & PENDANT LUMINAIRES

HÄNGE- & PENDELLEUCHTEN
LUMINAIRES SUSPENSIONS



EN **SUSPENDED LIGHTING**

Our wide variety of suspended and pendant luminaires contain classical as well as extravagant designs and supply any furnishing style. Set beautiful accents with your favourites and give your home a special atmosphere.

DE **BELEUCHTUNG ZUM ABHÄNGEN**

Unser breitgefächertes Hänge- und Pendelleuchten-Sortiment beinhaltet sowohl klassische als auch extravagante Designs und bedient jeden Einrichtungsstil. Setzen Sie mit Ihren Favoriten schöne Akzente und verleihen Sie Ihrem Zuhause eine besondere Atmosphäre.

FR **ÉCLAIRAGES SUSPENDUS**

Notre large gamme d'éclairages suspendus et pendulaires comprend aussi bien des designs classiques qu'extravagants et est adaptée à tout style d'ameublement. Mettez avec vos favoris de beaux accents et donnez une atmosphère particulière à votre intérieur.





OVERVIEW

HANGING & PENDANT LUMINAIRES
HÄNGE- & PENDELLEUCHTEN
LUMINAIRES SUSPENSIONS

 OIELLA 350-351	 AGUILARES 353	 LEBALIO 353	 MARYVILLA 354	 ALOBRASE 355, 358-361	 BATISTA 355	 CAPRAROLA 356	 COMINIO 357
 CADAQUES 361	 CADAQUES 1 361	 ARISCANI 362-363	 MURMILLO 364	 FARSALA 365	 MANTUNALLE 1 367	 BELESER 367	 MANTUNALLE 368
 SELVINO 370-371	 ALBARACCIN 372-373	 LAGUNITAS 374	 CERASELLA 375	 ROCAMAR 376,378	 ROCAMAR 1 377-378	 CORETTO 377	 LONCINO 1 379
 ALEANDRO 1 380	 ROMAGNESE 380	 VALLASPRA 381	 BATISTA 3 381	 BOLSANO 382	 CLEMENTE 383	 CARDITO 1 384-385	 VARRAZO 385
 LUBERIO 386	 MONTEFIO 1 386-387	 MIOGLIA 1 388	 CONESSA 388-389	 CARTAMA 391	 MONTEFINO 392	 CORTENOVA 394	 POZUETA 1 397
 POZUETA 399	 BOCADELLA 400	 MEZZANA 400	 GRADOLI 402	 GRADOLI 1 403	 MANIZALES 403	 CUMIOLE 404	 MONTEBALDO 405
 BITACHITO 405	 CORTADERAS 406	 RONDO 3 407	 PINETINA 407	 NARICES 407	 SARONA 408	 LOBATIA 409	 SILVARES 410



This product is available in different colors and shapes. / Dieser Artikel ist in unterschiedlichen Farben und Formen verfügbar. / Cet article est disponible en différentes couleurs et formes.





99614 OIELLA

pendant light; steel, black, brass / glass vaporized, black-brown-transparent

Hängeleuchte; Stahl, schwarz, messing / Glas bedampft, schwarz-braun-transparent

luminaire en suspension; acier, noir, laiton / verre vaporisé, noir marron transparent

H 1100, Ø 190



E27

1x 40W



9 002759 996147



99615 OIELLA

pendant light; steel, black, brass / glass vaporized, black-brown-transparent

Hängeleuchte; Stahl, schwarz, messing / Glas bedampft, schwarz-braun-transparent

luminaire en suspension; acier, noir, laiton / verre vaporisé, noir marron transparent

L 950, B 190, H 1100



E27

3x 40W



9 002759 996154



99616 OIELLA

pendant light; steel, black, brass / glass vaporized, black-grey-transparent

Hängeleuchte; Stahl, schwarz, messing / Glas bedampft, schwarz-grau-transparent

luminaire en suspension; acier, noir, laiton / verre vaporisé, noir gris transparent

H 1100, Ø 190



E27

1x 40W



9 002759 996161

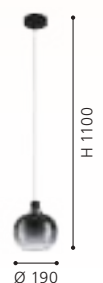



99617

99617 OILELLA

pendant light; steel, black, brass / glass vaporized, black-grey-transparent

Hängeleuchte; Stahl, schwarz, messing / Glas bedampft, schwarz-grau-transparent

luminaire en suspension; acier, noir, laiton / verre vaporisé, noir gris transparent

L 950, B 190, H 1100



E27



3x 40W



9 002759 996178

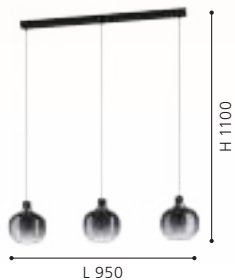

DESIGN
HIGHLIGHT
DETAIL



900196



900195



99314



99314

900196 AGUILARES

pendant light; steel, black / glass vaporized, black-grey-transparent

Hängeleuchte; Stahl, schwarz / Glas bedampft, schwarz-grau-transparent

luminaire en suspension; acier, noir / verre vaporisé, noir gris transparent

H 1100, Ø 430



E27 3x 40W



9 008606 235568

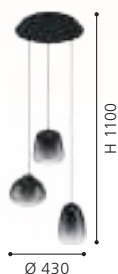

Ø 430

900195 AGUILARES

pendant light; steel, black / glass vaporized, black-grey-transparent

Hängeleuchte; Stahl, schwarz / Glas bedampft, schwarz-grau-transparent

luminaire en suspension; acier, noir / verre vaporisé, noir transparent

L 840, B 195, H 1045



E27 3x 40W



9 008606 235551



L 840

99314 LEBALIO

pendant light; steel, bronzed / glass vaporized, black-transparent

Hängeleuchte; Stahl, brüniert / Glas bedampft, schwarz-transparent

luminaire en suspension; acier, brun / verre vaporisé, noir transparent

L 1125, B 195, H 1100



E27 3x 40W



9 002759 993146

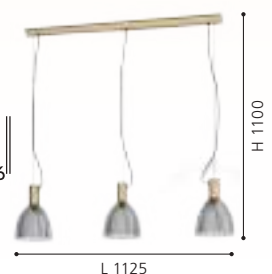

L 1125



900549 MARYVILLA

pendant light; steel, black, bronzed / glass vaporized, clear, gold
 Hängeleuchte; Stahl, schwarz, brüniert / Glas bedampft, klar, gold
 luminaire en suspension; acier, noir, brun / verre vaporisé, transparent, or

H 1100, Ø 170



900551 MARYVILLA

pendant light; steel, black, bronzed / glass vaporized, clear, gold
 Hängeleuchte; Stahl, schwarz, brüniert / Glas bedampft, klar, gold
 luminaire en suspension; acier, noir, brun / verre vaporisé, transparent, or

L 870, B 170, H 1100

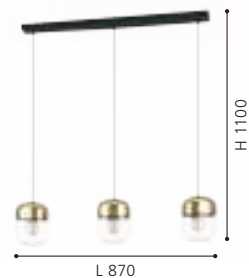



900506



900507



900508



900506 | 900507 | 900508

900506 ALOBRASE

pendant light; steel, black, brushed brass / satin glass, grey matt
Hängeleuchte; Stahl, schwarz, messing-gebürstet / Glas satiniert, grau matt
luminaire en suspension; acier, noir, laiton brossé / verre satiné, gris mat

H 1100, Ø 200



E27 1x 40W



9 008606 244362



900507 BATISTA

pendant light; steel, black, brushed brass / satin glass, grey matt
Hängeleuchte; Stahl, schwarz, messing-gebürstet / Glas satiniert, grau matt
luminaire en suspension; acier, noir, laiton brossé / verre satiné, gris mat

H 1100, Ø 120



E27 1x 40W



9 008606 244379

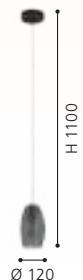

900508 BATISTA

pendant light; steel, black, brushed brass / satin glass, grey matt
Hängeleuchte; Stahl, schwarz, messing-gebürstet / Glas satiniert, grau matt
luminaire en suspension; acier, noir, laiton brossé / verre satiné, gris mat

L 945, B 120, H 1100



E27 4x 40W



9 008606 244386

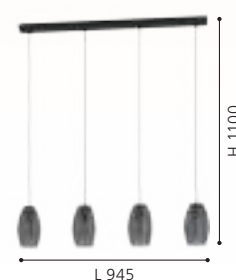



900813

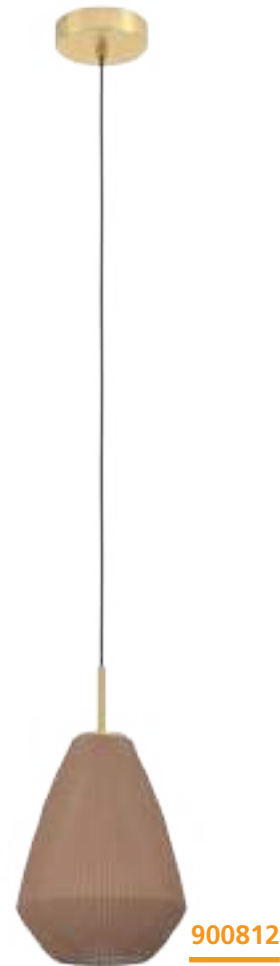

900812

CAPRAROLA, COMINIO

The shade colours of these luminaires look very different when switched on and off.

Die Schirmfarben dieser Leuchten sehen im ein- und ausgeschalteten Zustand sehr unterschiedlich aus.

Les couleurs de la teinte de ces luminaires sont très différentes lorsqu'ils sont allumés et éteints.



900813 CAPRAROLA

pendant light; steel, brushed brass / satin glass, sandy

Hängeleuchte; Stahl, messing-gebürstet / Glas satiniert, sandfarben

luminaire en suspension; acier, laiton brossé / verre satiné, couleur sable

L 900, B 200, H 1100



E27



3x 40W



9 008606 274338



900812 CAPRAROLA

pendant light; steel, brushed brass / satin glass, sandy

Hängeleuchte; Stahl, messing-gebürstet / Glas satiniert, sandfarben

luminaire en suspension; acier, laiton brossé / verre satiné, couleur sable

H 1100, Ø 200



E27



1x 40W



9 008606 274321





900893



900894

900893 COMINIO

pendant light; steel, taupe / etched glass, sandy
Hängeleuchte; Stahl, taupe / Glas geätzt, sandfarben
luminaire en suspension; acier, taupe / verre gravé, couleur sable

H 1100, Ø 185



E27 1x 40W



9 008606 274581



900894 COMINIO

pendant light; steel, taupe / etched glass, sandy
Hängeleuchte; Stahl, taupe / Glas geätzt, sandfarben
luminaire en suspension; acier, taupe / verre gravé, couleur sable

L 885, B 185, H 1100



E27 3x 40W



9 008606 274598

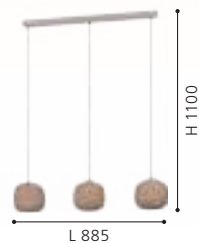



98614



98616



ALOBRASE

98614 ALOBRASE

pendant light; steel, chrome / glass vaporized, black-transparent
 Hängeleuchte; Stahl, chrom / Glas bedampft, schwarz-transparent
 luminaire en suspension; acier, chrome / verre vaporisé, noir transparent

H 1100, Ø 300



98616 ALOBRASE

pendant light; steel, chrome / glass vaporized, black-transparent
 Hängeleuchte; Stahl, chrom / Glas bedampft, schwarz-transparent
 luminaire en suspension; acier, chrome / verre vaporisé, noir transparent

L 1080, B 150, H 1100

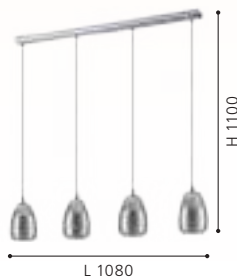

98615 ALOBRASE

pendant light; steel, chrome / glass vaporized, black-transparent
 Hängeleuchte; Stahl, chrom / Glas bedampft, schwarz-transparent
 luminaire en suspension; acier, chrome / verre vaporisé, noir transparent

H 1100, Ø 200

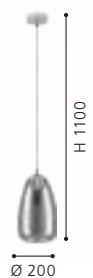



98615

98617 ALOBRASE

pendant light; steel, chrome / glass vaporized, black-transparent
Hängeleuchte; Stahl, chrom / Glas bedampft, schwarz-transparent
luminaire en suspension; acier, chrome / verre vaporisé, noir transparent

H 1500, Ø 540



E27



5x 40W



9 002759 986179

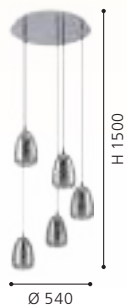

98617



98647



98649

98647 ALOBRASE

pendant light; steel, brushed brass / glass vaporized, amber
 Hängeleuchte; Stahl, messing-gebürstet / Glas bedampft, amber
 luminaire en suspension; acier, laiton brossé / verre vaporisé, ambre

H 1100, Ø 300



98649 ALOBRASE

pendant light; steel, brushed brass / glass vaporized, amber
 Hängeleuchte; Stahl, messing-gebürstet / Glas bedampft, amber
 luminaire en suspension; acier, laiton brossé / verre vaporisé, ambre

L 1080, B 150, H 1100

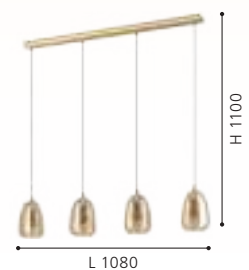



98648



98582



98585

98648 ALOBRASE

pendant light; steel, brushed brass / glass vaporized, amber
Hängeleuchte; Stahl, messing-gebürstet / Glas bedampft, amber
luminaire en suspension; acier, laiton brossé / verre vaporisé, ambre

H 1100, Ø 200



98582 CADAQUES

pendant light; steel, black / smoked glass, black-transparent
Hängeleuchte; Stahl, schwarz / Rauchglas, schwarz-transparent
luminaire en suspension; acier, noir / verre fumé, noir transparent

H 1100, Ø 180



98585 CADAQUES 1

pendant light; steel, black / smoked glass, black-transparent
Hängeleuchte; Stahl, schwarz / Rauchglas, schwarz-transparent
luminaire en suspension; acier, noir / verre fumé, noir transparent

H 1100, Ø 160





ARISCANI



98651

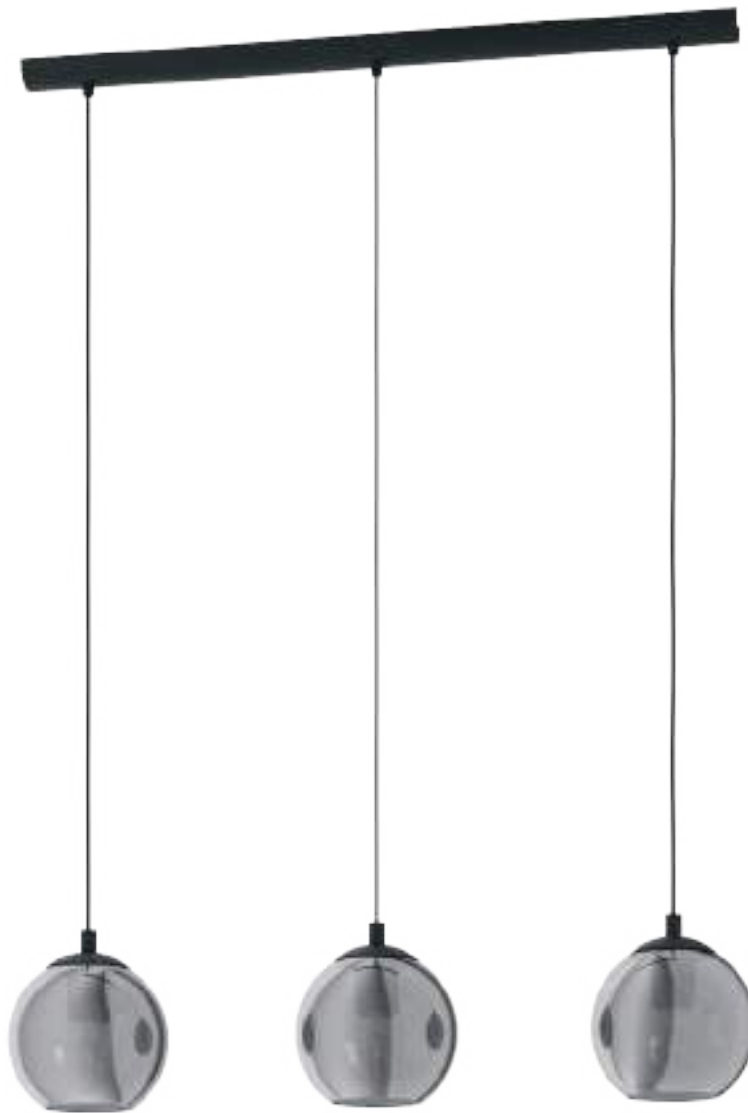

98652

98651 ARISCANI

pendant light; steel, black / glass vaporized, black-transparent
Hängeleuchte; Stahl, schwarz / Glas bedampft, schwarz-transparent

luminaire en suspension; acier, noir / verre vaporisé, noir transparent

H 1100, Ø 200



E27 1x 40W



9 002759 986513



98652 ARISCANI

pendant light; steel, black / glass vaporized, black-transparent
Hängeleuchte; Stahl, schwarz / Glas bedampft, schwarz-transparent

luminaire en suspension; acier, noir / verre vaporisé, noir transparent

L 765, B 165, H 1100



E27 3x 40W



9 002759 986520

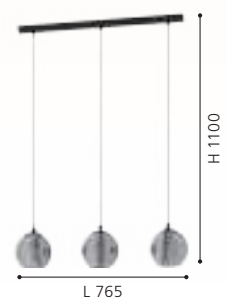



98653



98654

98653 ARISCANI

pendant light; steel, black / glass vaporized, black-transparent
 Hängeleuchte; Stahl, schwarz / Glas bedampft, schwarz-transparent
 luminaire en suspension; acier, noir / verre vaporisé, noir transparent

H 1100, Ø 425



E27 3x 40W



9 002759 986537



98654 ARISCANI

pendant light; steel, black / glass vaporized, black-transparent
 Hängeleuchte; Stahl, schwarz / Glas bedampft, schwarz-transparent
 luminaire en suspension; acier, noir / verre vaporisé, noir transparent

H 1700, Ø 655



E27 10x 40W



9 002759 986544





96774



96773



MURMILLO

96774 MURMILLO

pendant light; steel, chrome / smoked glass, black-transparent
 Hängeleuchte; Stahl, chrom / Rauchglas, schwarz-transparent
 luminaire en suspension; acier, chrome / verre fumé, noir transparent

L 770, B 170, H 1500



E27



3x 28W



9 002759 967741



96773 MURMILLO

pendant light; steel, chrome / smoked glass, black-transparent
 Hängeleuchte; Stahl, chrom / Rauchglas, schwarz-transparent
 luminaire en suspension; acier, chrome / verre fumé, noir transparent

H 1500, Ø 170



E27



1x 28W



9 002759 967734





96343

LED

96344

LED

96345

LED

96343 FARSALA

pendant light; steel, satin nickel / smoked glass, granules, black-transparent, clear

Hängeleuchte; Stahl, nickel-matt / Rauchglas, Granille, schwarz-transparent, klar

luminaire en suspension; acier, nickel mat / verre fumé, granité, noir transparent, transparent

H 1100, Ø 125



G9



1x 3W



1x warm WHITE

320lm



9 002759 963439



96344 FARSALA

pendant light; steel, satin nickel / smoked glass, granules, black-transparent, clear

Hängeleuchte; Stahl, nickel-matt / Rauchglas, Granille, schwarz-transparent, klar

luminaire en suspension; acier, nickel mat / verre fumé, granité, noir transparent, transparent

L 975, B 100, H 1100



G9



4x 3W



4x warm WHITE

320lm

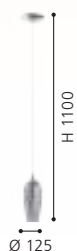

Ø 125



9 002759 963446

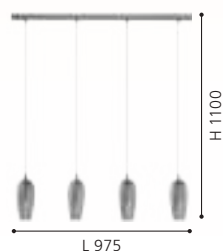

L 975

96345 FARSALA

pendant light; steel, satin nickel / smoked glass, granules, black-transparent, clear

Hängeleuchte; Stahl, nickel-matt / Rauchglas, Granille, schwarz-transparent, klar

luminaire en suspension; acier, nickel mat / verre fumé, granité, noir transparent, transparent

H 1500, Ø 350



G9



5x 3W



5x warm WHITE

320lm



9 002759 963453



Ø 350



99371



98384 | 99371



98384

99371 MANTUNALLE 1

pendant light; steel, black / glass vaporized, black-transparent
 Hängeleuchte; Stahl, schwarz / Glas bedampft, schwarz-transparent
 luminaire en suspension; acier, noir / verre vaporisé, noir transparent

H 1100, Ø 200



98384 BELESER

pendant light; steel, black / glass vaporized, black-transparent
 Hängeleuchte; Stahl, schwarz / Glas bedampft, schwarz-transparent
 luminaire en suspension; acier, noir / verre vaporisé, noir transparent

L 905, B 205, H 1100



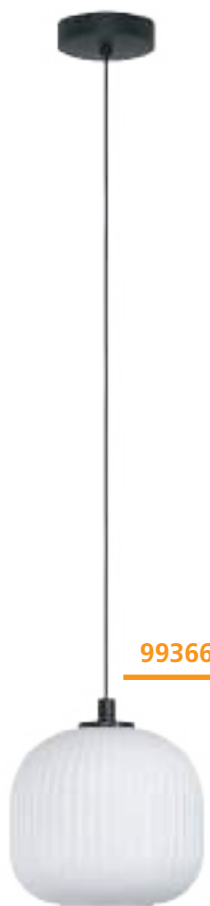

99366



99368



99366



99367 | 99368

99366 MANTUNALLE

pendant light; steel, black / glass, white
 Hängeleuchte; Stahl, schwarz / Glas, weiss
 luminaire en suspension; acier, noir / verre, blanc

H 1100, Ø 200



E27 1x 40W



9 002759 993665



99368 MANTUNALLE

pendant light; steel, black / glass, white
 Hängeleuchte; Stahl, schwarz / Glas, weiss
 luminaire en suspension; acier, noir / verre, blanc

H 1100, Ø 620



E27 3x 40W



9 002759 993689



99367 MANTUNALLE

pendant light; steel, black / glass, white
 Hängeleuchte; Stahl, schwarz / Glas, weiss
 luminaire en suspension; acier, noir / verre, blanc

L 1200, B 200, H 1100



E27 3x 40W



9 002759 993672



99367





98696



98697



98694



98694 | 98695

98696 SELVINO

pendant light; steel, satin nickel / glass vaporized, gold-coloured, brown

Hängeleuchte; Stahl, nickel-matt / Glas bedampft, goldfarben
luminaire en suspension; acier, nickel mat / verre vaporisé, couleur or

H 1100, Ø 100



9 002759 986964



98697 SELVINO

pendant light; steel, satin nickel / glass vaporized, gold-coloured, brown

Hängeleuchte; Stahl, nickel-matt / Glas bedampft, goldfarben
luminaire en suspension; acier, nickel mat / verre vaporisé, couleur or

L 710, B 100, H 1100



9 002759 986971

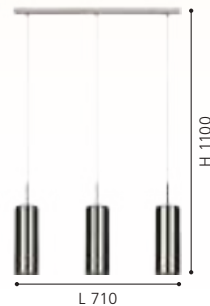

98694 SELVINO

pendant light; steel, satin nickel / glass vaporized, black-transparent

Hängeleuchte; Stahl, nickel-matt / Glas bedampft, schwarz-transparent
luminaire en suspension; acier, nickel mat / verre vaporisé, noir transparent

H 1100, Ø 100



9 002759 986940





98696 | 98697 | 98698 |
98699

98695 SELVINO

pendant light; steel, satin nickel / glass vaporized, black-transparent

Hängeleuchte; Stahl, nickel-matt / Glas bedampft, schwarz-transparent

luminaire en suspension; acier, nickel mat / verre vaporisé, noir transparent

L 710, B 100, H 1100



E27 3x 15W



9 002759 986957

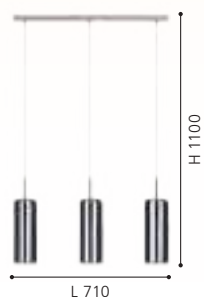

98698 SELVINO

pendant light; steel, satin nickel / glass vaporized, copper-coloured

Hängeleuchte; Stahl, nickel-matt / Glas bedampft, kupferfarben

luminaire en suspension; acier, nickel mat / verre vaporisé, cuivré

H 1100, Ø 100



E27 1x 15W



9 002759 986988

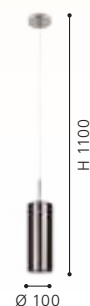

98699 SELVINO

pendant light; steel, satin nickel / glass vaporized, copper-coloured

Hängeleuchte; Stahl, nickel-matt / Glas bedampft, kupferfarben

luminaire en suspension; acier, nickel mat / verre vaporisé, cuivré

L 710, B 100, H 1100



E27 3x 15W



9 002759 986995



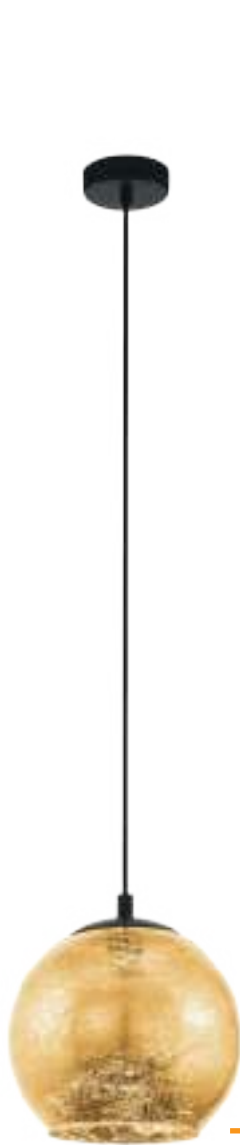

98523



98524



98526

98523 ALBARACCIN

pendant light; steel, black / glass, gold-coloured, brown
Hängeleuchte; Stahl, schwarz / Glas, goldfarben
luminaire en suspension; acier, noir / verre, couleur or

H 1100, Ø 270



E27



1x 40W



9 002759 985233

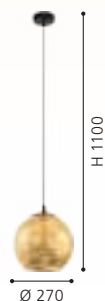

98524 ALBARACCIN

pendant light; steel, black / glass, gold-coloured, brown
Hängeleuchte; Stahl, schwarz / Glas, goldfarben
luminaire en suspension; acier, noir / verre, couleur or

H 1100, Ø 190



E27



1x 40W



9 002759 985240



98526 ALBARACCIN

pendant light; steel, black / glass, gold-coloured, brown
Hängeleuchte; Stahl, schwarz / Glas, goldfarben
luminaire en suspension; acier, noir / verre, couleur or

H 1500, Ø 585



E27



5x 40W



9 002759 985264





98525

98525 ALBARACCIN

pendant light; steel, black / glass, gold-coloured, brown
Hängeleuchte; Stahl, schwarz / Glas, goldfarben
luminaire en suspension; acier, noir / verre, couleur or

L 780, B 190, H 1100



E27



3x 40W



9 002759 985257





99654

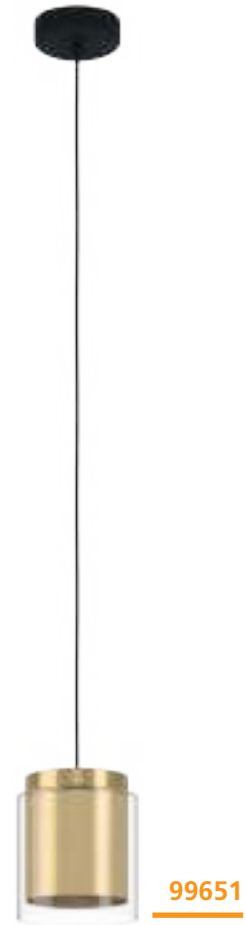

99651

99654 LAGUNITAS

pendant light; steel, black, brass, gold / glass, clear
 Hängeleuchte; Stahl, schwarz, messing, gold / Glas, klar
 luminaire en suspension; acier, noir, laiton, or / verre, transparent

L 910, B 150, H 1100



E27



3x 40W



9 002759 996543



99651 LAGUNITAS

pendant light; steel, black, brass, gold / glass, clear
 Hängeleuchte; Stahl, schwarz, messing, gold / Glas, klar
 luminaire en suspension; acier, noir, laiton, or / verre, transparent

H 1100, Ø 150



E27



1x 40W



9 002759 996512





99628

LED



99629

LED



99628 CERASELLA

pendant light; steel, brushed brass / glass, clear
Hängeleuchte; Stahl, messing-gebürstet / Glas, klar
luminaire en suspension; acier, laiton brossé / verre, transparent

H 1100, Ø 200



GU10



1x 4,5W



1x

345lm



9 002759 996284



INCL.



Ø 200

99629 CERASELLA

pendant light; steel, brushed brass / glass, clear
Hängeleuchte; Stahl, messing-gebürstet / Glas, klar
luminaire en suspension; acier, laiton brossé / verre, transparent

L 900, B 200, H 1100



GU10



3x 4,5W



3x

345lm



9 002759 996291



INCL.



L 900

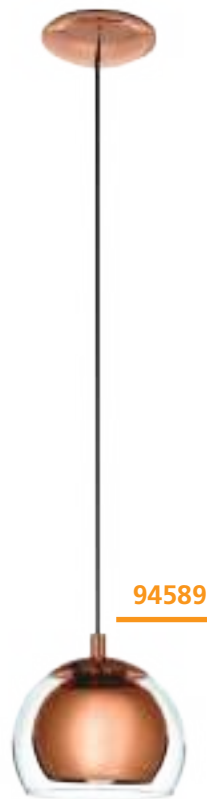

94589

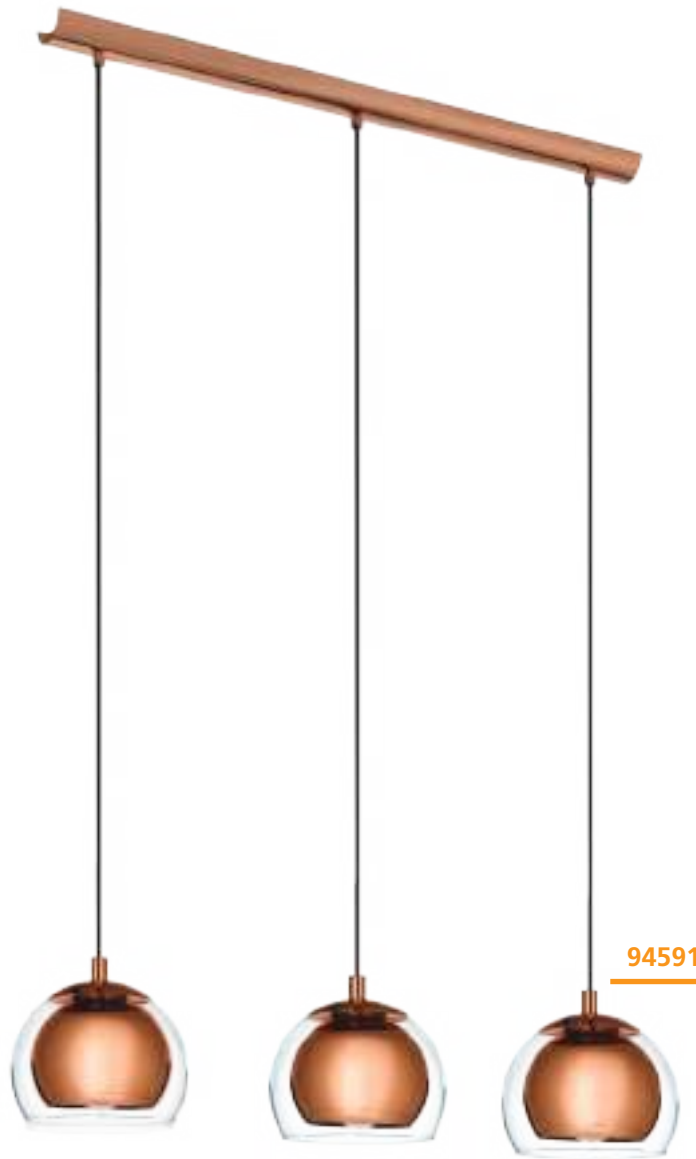

94591

DESIGN
HIGHLIGHT
DETAIL

94589 ROCAMAR

pendant light; steel, copper / glass, clear
Hängeleuchte; Stahl, kupfer / Glas, klar
luminaire en suspension; acier, cuivre / verre, transparent

H 1100, Ø 190



9 002759 945893



94591 ROCAMAR

pendant light; steel, copper / glass, clear
Hängeleuchte; Stahl, kupfer / Glas, klar
luminaire en suspension; acier, cuivre / verre, transparent

L 780, B 190, H 1100



9 002759 945916

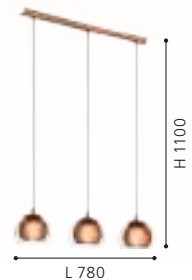



98595



93836

98595 ROCAMAR 1

pendant light; steel, copper / glass, clear
 Hängeleuchte; Stahl, kupfer / Glas, klar
 luminaire en suspension; acier, cuivre / verre, transparent

H 1500, Ø 585



E27 5x 28W



9 002759 985950

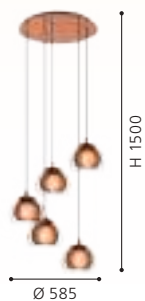

93836 CORETTO

pendant light; steel, brushed copper
 Hängeleuchte; Stahl, kupfer-gebürstet
 luminaire en suspension; acier, cuivre brossé

H 1100, Ø 170

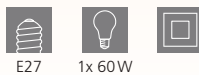

E27 1x 60W



9 002759 938369



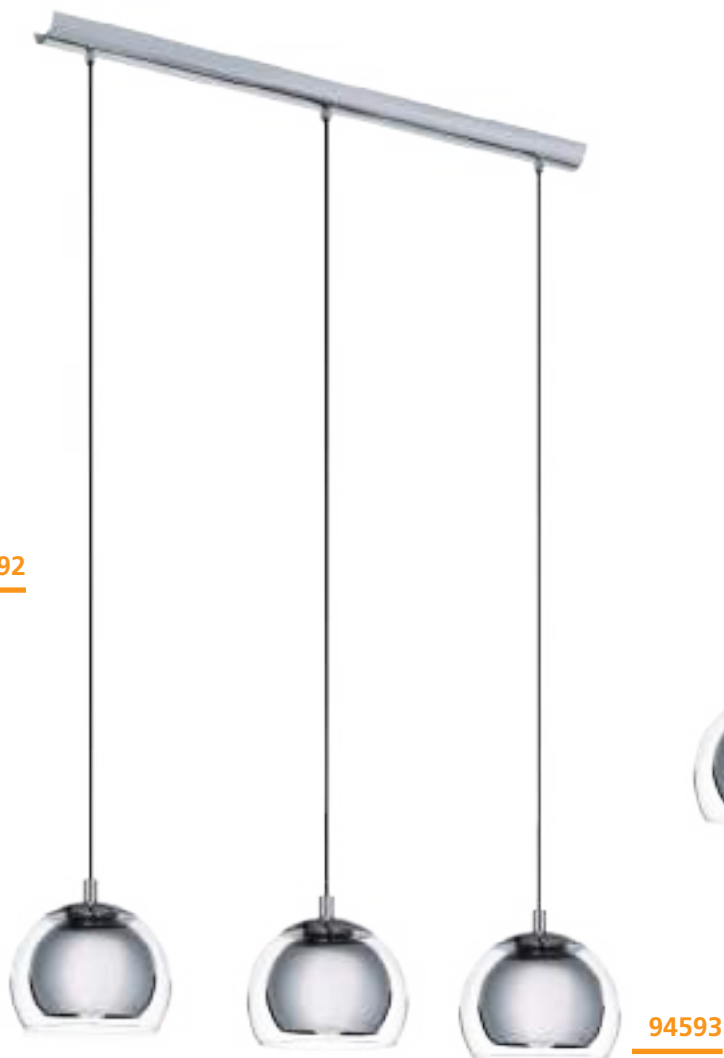
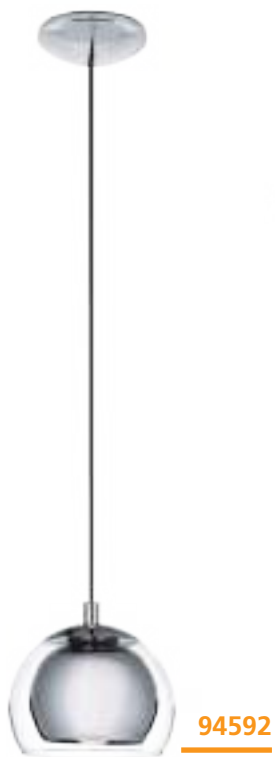

94592 ROCAMAR

pendant light; steel, chrome / glass, clear
 Hängeleuchte; Stahl, chrom / Glas, klar
 luminaire en suspension; acier, chrome / verre, transparent

H 1100, Ø 190



9 002759 945923



94593 ROCAMAR

pendant light; steel, chrome / glass, clear
 Hängeleuchte; Stahl, chrom / Glas, klar
 luminaire en suspension; acier, chrome / verre, transparent

L 780, B 190, H 1100



9 002759 945930



98596 ROCAMAR 1

pendant light; steel, chrome / glass, clear
 Hängeleuchte; Stahl, chrom / Glas, klar
 luminaire en suspension; acier, chrome / verre, transparent

H 1500, Ø 585



9 002759 985967

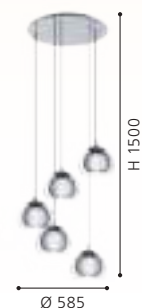



94378



94377

DESIGN
HIGHLIGHT
DETAIL



LONCINO 1

94378 LONCINO 1

pendant light; steel, chrome / glass, satin glass, clear, white
Hängeleuchte; Stahl, chrom / Glas, Glas satiniert, klar, weiss
luminaire en suspension; acier, chrome / verre, verre satiné,
transparent, blanc

L 745, B 150, H 1100



E27



3x 60W



9 002759 943783



94377 LONCINO 1

pendant light; steel, chrome / glass, satin glass, clear, white
Hängeleuchte; Stahl, chrom / Glas, Glas satiniert, klar, weiss
luminaire en suspension; acier, chrome / verre, verre satiné,
transparent, blanc

L 150, B 150, H 1100



E27



1x 60W



9 002759 943776





96528

LED

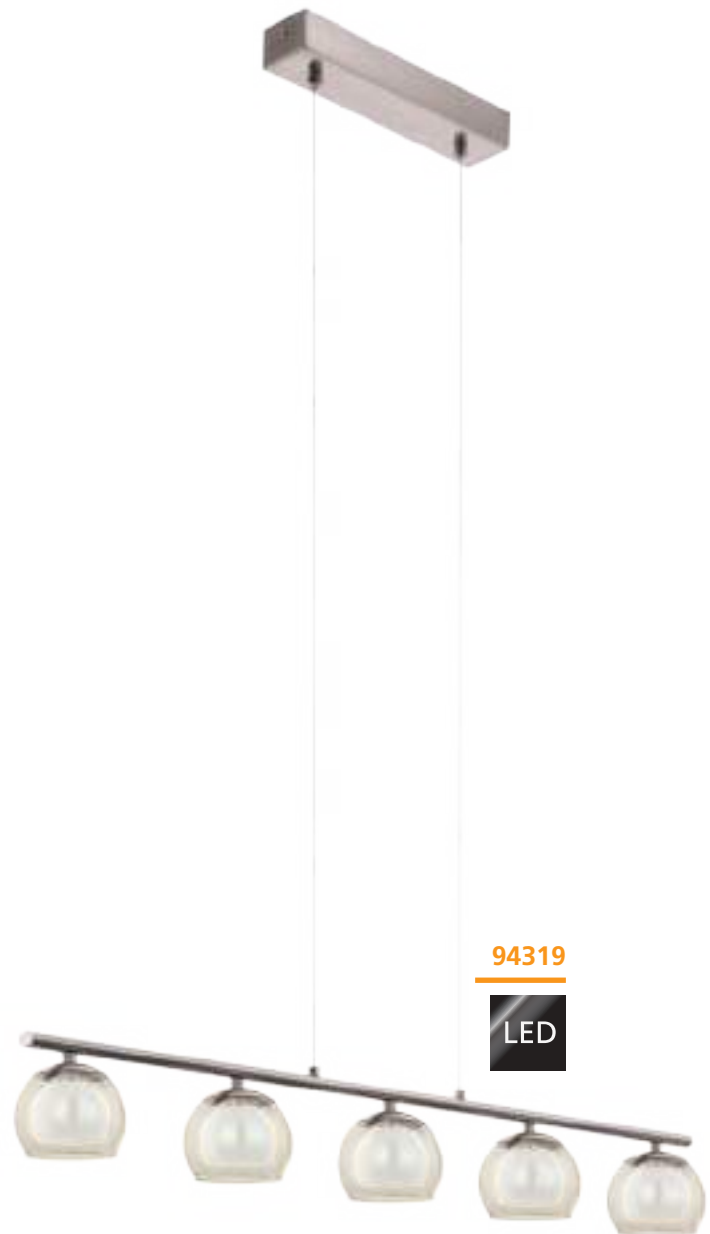

94319

LED

96528 ALEANDRO 1

pendant light; steel, chrome / matte-opal glass, white
 Hängeleuchte; Stahl, chrom / Glas opal-matt, weiss
 luminaire en suspension; acier, chrome / verre opale mat, blanc

L 800, B 120, H 860 - 1550



4x 4,5W 2000lm



9 002759 965280

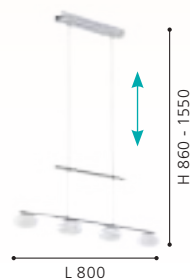

94319 ROMAGNESE

pendant light; steel, satin nickel / glass, satin glass, amber, white
 Hängeleuchte; Stahl, nickel-matt / Glas, Glas satiniert, ambre, weiss
 luminaire en suspension; acier, nickel mat / verre, verre satiné, ambre, blanc

L 900, B 105, H 1100



5x 3,3W 1700lm



9 002759 943196





97793 VALLASPRA

pendant light; steel, champagne / matte-opal glass, white
 Hängeleuchte; Stahl, champagner / Glas opal-matt, weiss
 luminaire en suspension; acier, champagne / verre opale mat, blanc

L 910, B 165, H 1100

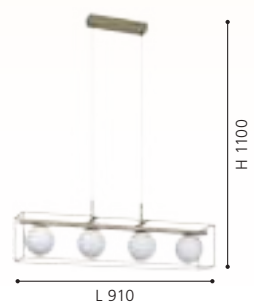
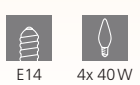

97587 BATISTA 3

pendant light; steel, satin nickel / glass wiping technique, white
 Hängeleuchte; Stahl, nickel-matt / Glas Wischtechnik, weiss
 luminaire en suspension; acier, nickel mat / technique de verre essuyé, blanc

L 1020, B 120, H 1100

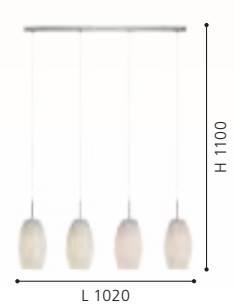



92762



92761

92762 BOLSANO

pendant light; steel, chrome / satin glass, glass, white, clear
 Hängeleuchte; Stahl, chrom / Glas satiniert, Glas, weiss, klar
 luminaire en suspension; acier, chrome / verre satiné, verre, blanc, transparent

H 1300, Ø 505



E27 3x 60W



9 002759 927622



92761 BOLSANO

pendant light; steel, chrome / satin glass, glass, white, clear
 Hängeleuchte; Stahl, chrom / Glas satiniert, Glas, weiss, klar
 luminaire en suspension; acier, chrome / verre satiné, verre, blanc, transparent

H 1300, Ø 200



E27 1x 60W



9 002759 927615





EGLO
RECOMMENDS
110003
CLEMENTE

95286



95287

95286 CLEMENTE

pendant light; steel, chrome / brilliant glass, clear
Hängeleuchte; Stahl, chrom / Brillantglas, klar
luminaire en suspension; acier, chrome / verre brillant, transparent

H 1100, Ø 350



9 002759 952860



95287 CLEMENTE

pendant light; steel, chrome / brilliant glass, clear
Hängeleuchte; Stahl, chrom / Brillantglas, klar
luminaire en suspension; acier, chrome / verre brillant, transparent

H 1100, Ø 540



9 002759 952877





93625

LED

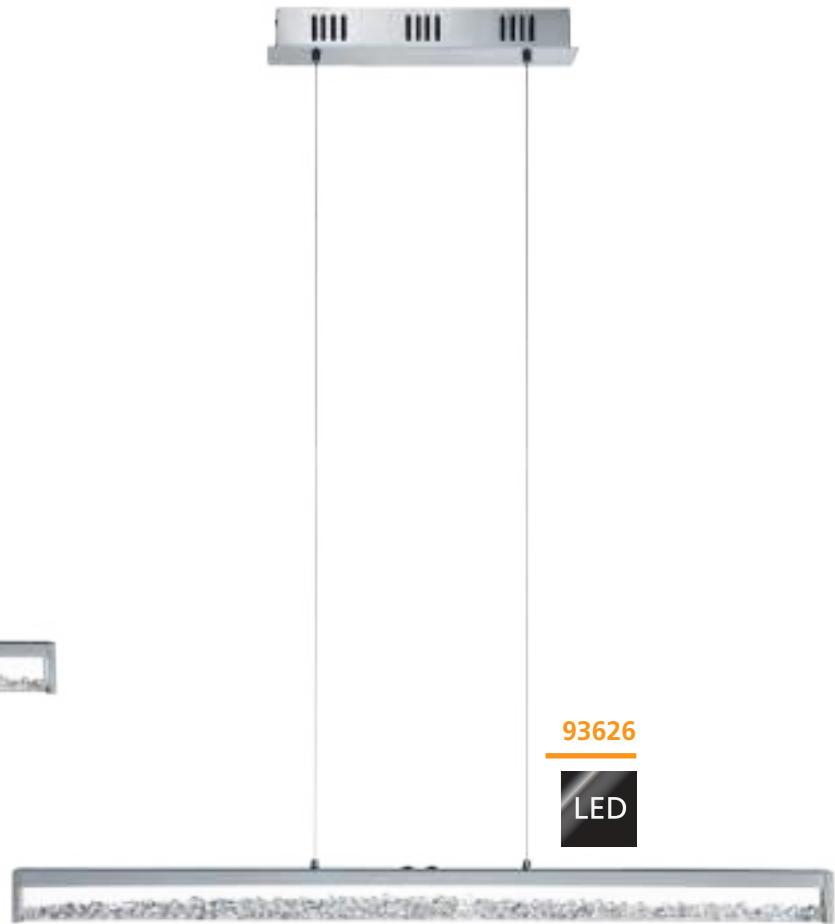

93626

LED



TOUCH ME



see the tunable white video
 unser Tunable White Video
 notre video de blanc réglable

CARDITO 1



Warm White 2700K Neutral White Cold White 5000K

These luminaires can be switched on and off by touching the specially designed "Touch Me" part of the fixture. Features via touch-dimmer:

- > light colour adjustable between 2700K - 5000K
- > dimmable 10% - 100%

Diese Leuchten können ein und ausgeschaltet werden, indem man sie an den dafür vorgesehenen „Touch Me“ Bereichen berührt. Per Touch-Dimmer verfügen diese Leuchten über folgende Funktionen:

- > Lichtfarbe einstellbar im Bereich 2700K bis 5000K
- > dimmbar 10% bis 100%

Ces luminaires peuvent être éteints et allumés simplement en touchant la partie spécialement conçue pour «Touch Me» du luminaire. Fonctions du gradateur «touch»:

- > couleur lumineuse réglable de 2700K - 5000K
- > réglable en luminosité 10% - 100%

93625 CARDITO 1

pendant light; aluminium, steel, chrome / glass, brilliant glass, clear

Hängeleuchte; Alu, Stahl, chrom / Glas, Brillantglas, klar

luminaire en suspension; aluminium, acier, chrome / verre, verre brillant, transparent

L 700, B 80, H 750 - 1300



4x 6W



2280lm



9 002759 936259

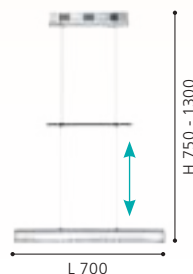

93626 CARDITO 1

pendant light; aluminium, steel, chrome / glass, brilliant glass, clear

Hängeleuchte; Alu, Stahl, chrom / Glas, Brillantglas, klar

luminaire en suspension; aluminium, acier, chrome / verre, verre brillant, transparent

L 1000, B 80, H 1100



6x 6W



3420lm



9 002759 936266

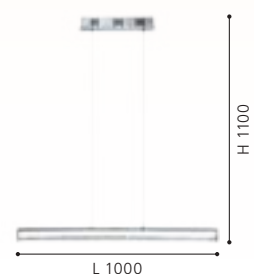

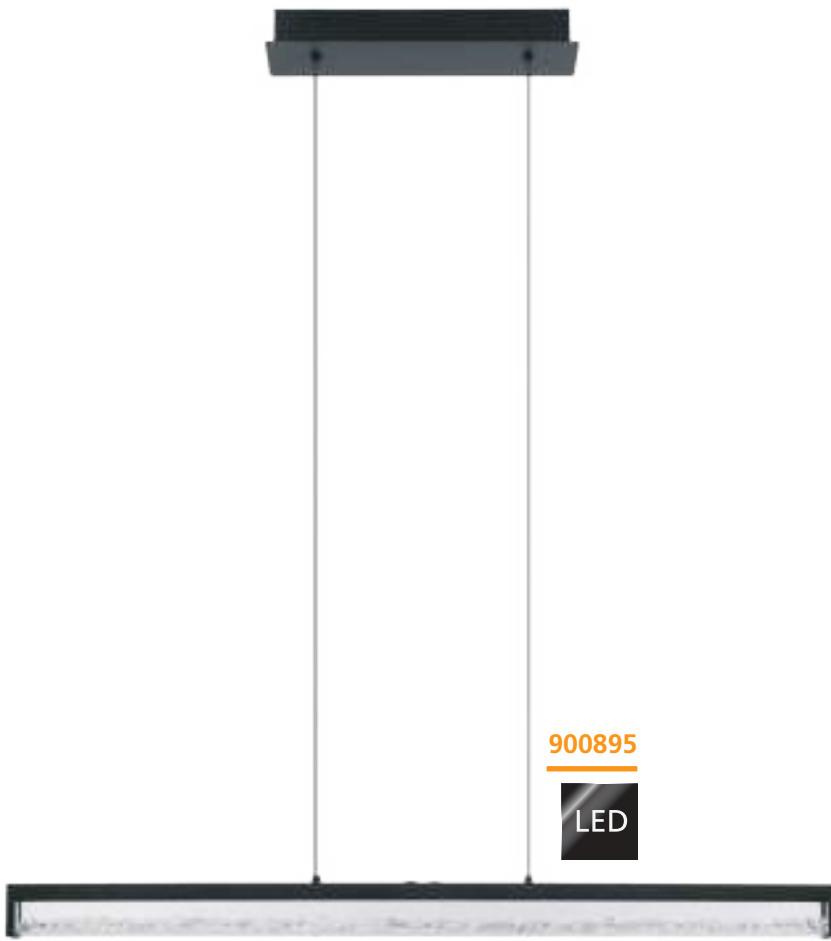

900895



31667



900895 CARDITO 1

pendant light; aluminium, steel, black / glass, brilliant glass, clear
 Hängeleuchte; Alu, Stahl, schwarz / Glas, Brillantglas, klar
 luminaire en suspension; aluminium, acier, noir / verre, verre
 brillant, transparent

L 1000, B 80, H 1100



6x 6W 3420lm



9 008606 267941

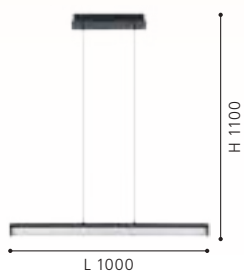

31667 VARRAZO

pendant light; steel, chrome / brilliant glass, clear
 Hängeleuchte; Stahl, chrom / Brillantglas, klar
 luminaire en suspension; acier, chrome / verre brillant, trans-
 parent

H 1200, Ø 550



29W 4300lm



9 002759 316679

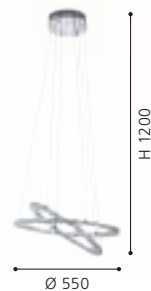

MONTEFIO 1

These luminaires come with high quality brilliant glass.

Diese Leuchten sind mit hochwertigem Brillantglas ausgestattet.

Ces lumières sont fabriquées avec une haute qualité Equipé de verre brillant.



93073



93709

LED

93073 LUBERIO

pendant light; steel, chrome / glass, aluminium, clear, aluminium
Hängeleuchte; Stahl, chrom / Glas, Alu, klar, alu
luminaire en suspension; acier, chrome / verre, aluminium, transparent, aluminium

H 1100, Ø 250



E27



1x 60W



9 002759 930738



93709 MONTEFIO 1

pendant light; steel, chrome / glass, brilliant glass, white, clear
Hängeleuchte; Stahl, chrom / Glas, Brillantglas, weiss, klar
luminaire en suspension; acier, chrome / verre, verre brillant, blanc, transparent

H 1100, Ø 400



LED



warm
WHITE
3x 5W 1500lm



9 002759 937096

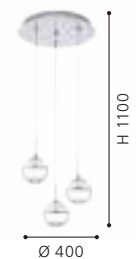



93708

LED



93784

LED

93708 MONTEFIO 1

pendant light; steel, chrome / glass, brilliant glass, white, clear
 Hängeleuchte; Stahl, chrom / Glas, Brillantglas, weiss, klar
 luminaire en suspension; acier, chrome / verre, verre brillant,
 blanc, transparent

H 1100, Ø 140



1x 5W 480lm



9 002759 937089



93784 MONTEFIO 1

pendant light; steel, chrome / glass, brilliant glass, white, clear
 Hängeleuchte; Stahl, chrom / Glas, Brillantglas, weiss, klar
 luminaire en suspension; acier, chrome / verre, verre brillant,
 blanc, transparent

L 870, B 140, H 1100



3x 5W 1500lm



9 002759 937843

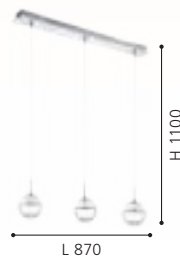

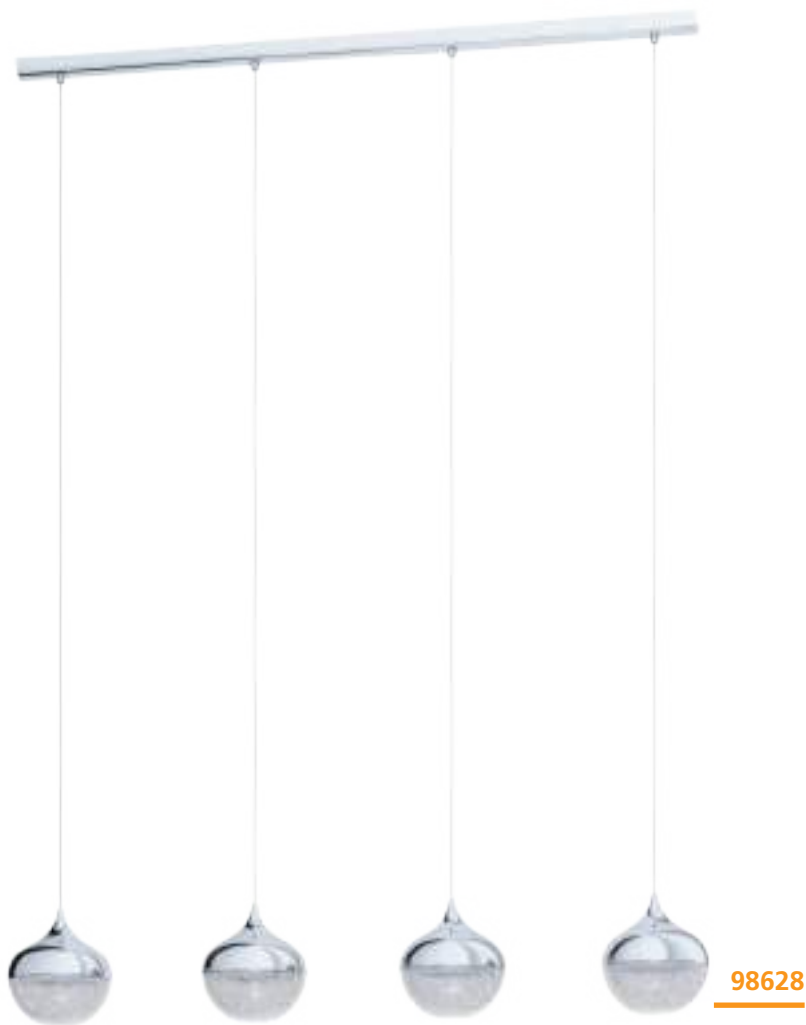

98628



98629



MIOGLIA 1

98628 MIOGLIA 1

pendant light; steel, chrome / plastic, white granules, clear
 Hängeleuchte; Stahl, chrom / Kunststoff, granille weiss, klar
 luminaire en suspension; acier, chrome / plastique, blanc granille, transparent

L 975, B 150, H 1100



E14

4x 25W



9 002759 986285

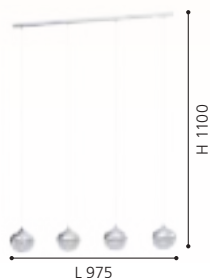

98629 MIOGLIA 1

pendant light; steel, chrome / plastic, white granules, clear
 Hängeleuchte; Stahl, chrom / Kunststoff, granille weiss, klar
 luminaire en suspension; acier, chrome / plastique, blanc granille, transparent

H 1500, Ø 540



E14

5x 25W



9 002759 986292



95913 CONESSA

pendant light; steel, chrome / plastic, clear
 Hängeleuchte; Stahl, chrom / Kunststoff, klar
 luminaire en suspension; acier, chrome / plastique, transparent

H 1100, Ø 290



GU10

3x 3W

3x

250lm



9 002759 959135

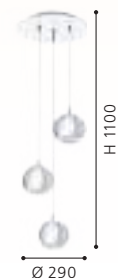



95913

LED

95912

LED



95914

LED

95912 CONESSA

pendant light; steel, chrome / plastic, clear
 Hängeleuchte; Stahl, chrom / Kunststoff, klar
 luminaire en suspension; acier, chrome / plastique, transparent

L 1010, B 150, H 1100



GU10



4x 3W



4x
 250lm



9 002759 959128

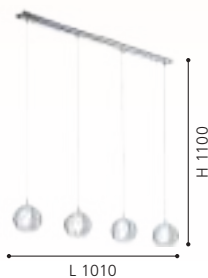

95914 CONESSA

pendant light; steel, chrome / plastic, clear
 Hängeleuchte; Stahl, chrom / Kunststoff, klar
 luminaire en suspension; acier, chrome / plastique, transparent

H 1700, Ø 580



GU10



10x 3W



10x
 250lm



9 002759 959142

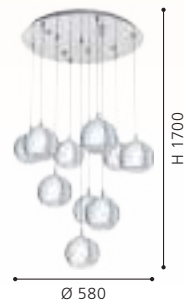



94244

LED

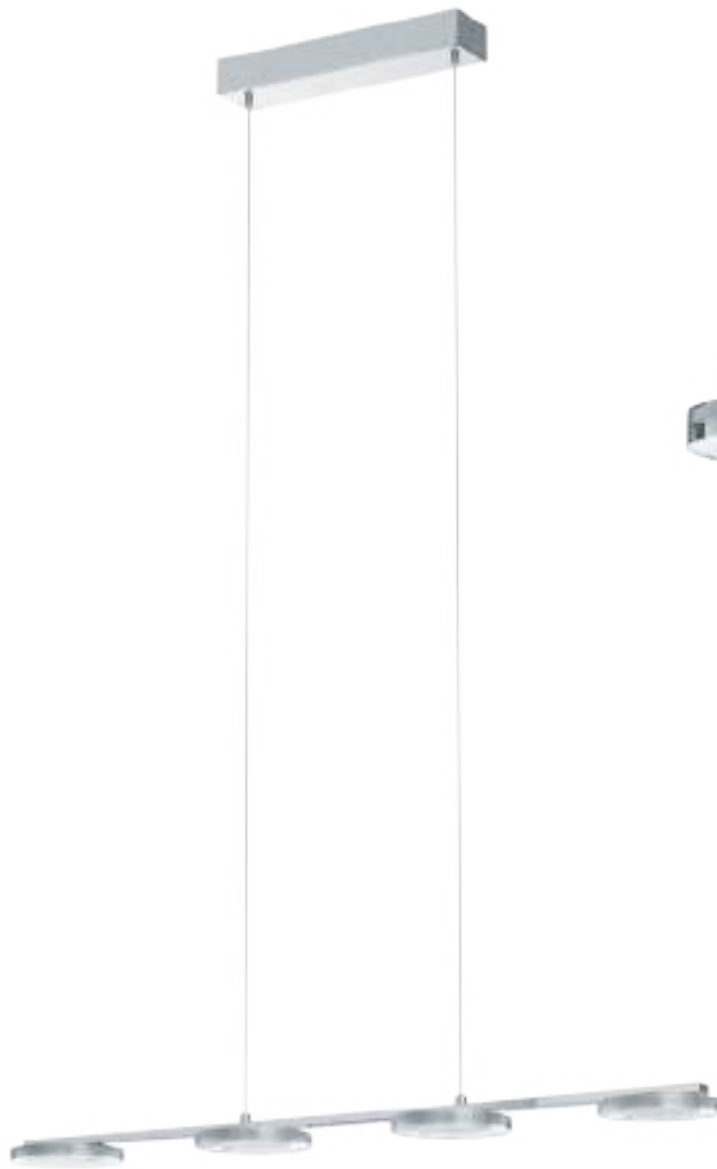

DESIGN
HIGHLIGHT
DETAIL

94245

LED

94244 CARTAMA

pendant light; steel, chrome / plastic, clear, satin finish
Hängeleuchte; Stahl, chrom / Kunststoff, klar, satiniert
luminaire en suspension; acier, chrome / plastique, transparent, satiné

L 780, B 90, H 1100



4x 4,6W 2200lm

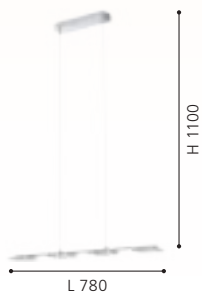

94245 CARTAMA

pendant light; steel, chrome / plastic, clear, satin finish
Hängeleuchte; Stahl, chrom / Kunststoff, klar, satiniert
luminaire en suspension; acier, chrome / plastique, transparent, satiné

L 775, B 115, H 1100



4x 4,6W 2200lm

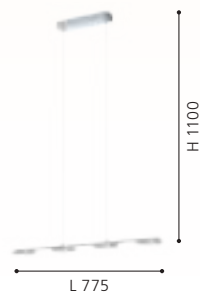



97366

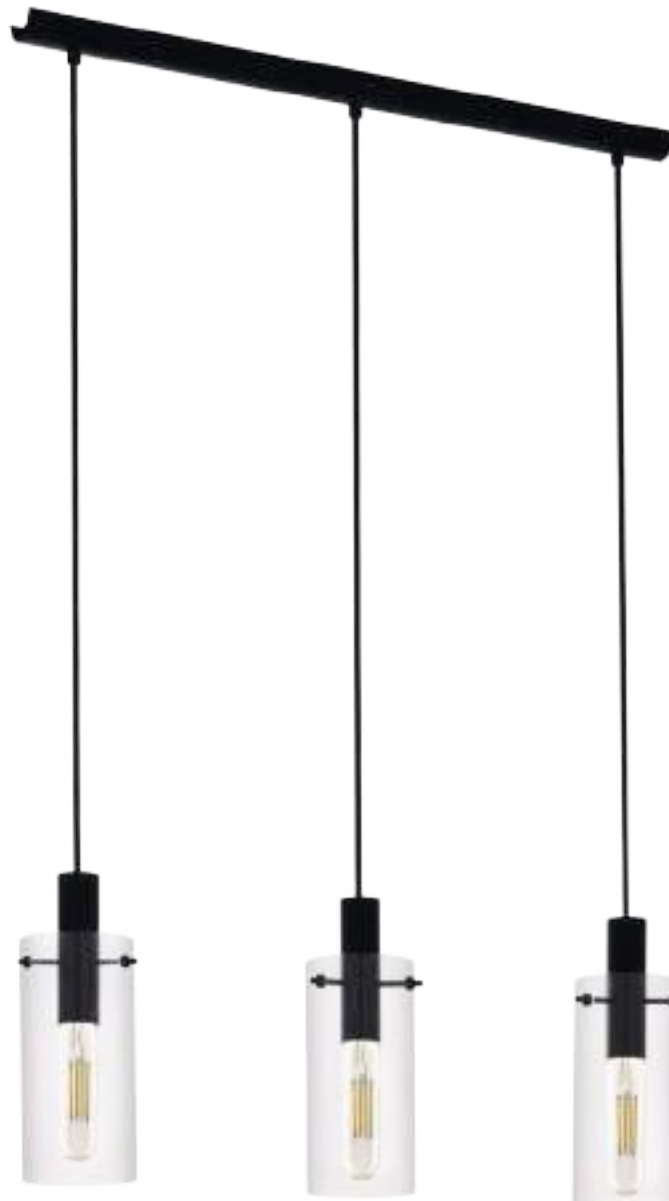

97367

97366 MONTEFINO

pendant light; steel, black / glass, clear
 Hängeleuchte; Stahl, schwarz / Glas, klar
 luminaire en suspension; acier, noir / verre, transparent

H 1100, Ø 110



9 002759 973667

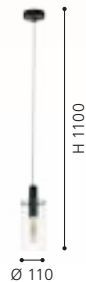

97367 MONTEFINO

pendant light; steel, black / glass, clear
 Hängeleuchte; Stahl, schwarz / Glas, klar
 luminaire en suspension; acier, noir / verre, transparent

L 730, B 110, H 1100



9 002759 973674



97368 MONTEFINO

pendant light; steel, black / glass, clear
 Hängeleuchte; Stahl, schwarz / Glas, klar
 luminaire en suspension; acier, noir / verre, transparent

H 1500, Ø 350



9 002759 973681





97368



98056



98058

98056 CORTENOVA

pendant light; steel, black
Hängeleuchte; Stahl, schwarz
luminaire en suspension; acier, noir

H 1100, Ø 105



E27



1x 60W



9 002759 980566



98058 CORTENOVA

pendant light; steel, black
Hängeleuchte; Stahl, schwarz
luminaire en suspension; acier, noir

H 1500, Ø 350



E27



5x 60W



9 002759 980580



98057 CORTENOVA

pendant light; steel, black
Hängeleuchte; Stahl, schwarz
luminaire en suspension; acier, noir

L 840, B 60, H 1100



E27



4x 60W



9 002759 980573

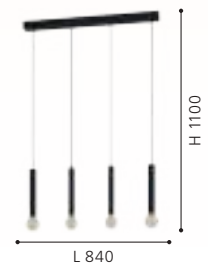



98057



900799



900798



900801



900799 POZUETA 1

pendant light; steel, brushed brass
Hängeleuchte; Stahl, messing-gebürstet
luminaire en suspension; acier, laiton brossé

H 1100, Ø 65



E27 1x 40W



9 008606 270248



900798 POZUETA 1

pendant light; steel, white
Hängeleuchte; Stahl, weiss
luminaire en suspension; acier, blanc

H 1100, Ø 65



E27 1x 40W



9 008606 270231

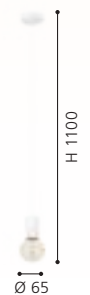

900801 POZUETA 1

pendant light; steel, wood, black, brown
Hängeleuchte; Stahl, Holz, schwarz, braun
luminaire en suspension; acier, bois, noir, marron

H 1100, Ø 65



E27 1x 40W



9 008606 270255





98661





98663



98662



POZUETA

98661 POZUETA

pendant light; steel, black
Hängeleuchte; Stahl, schwarz
luminaire en suspension; acier, noir

H 1100, Ø 125



E27 1x 40W



9 002759 986612



98663 POZUETA

pendant light; steel, black
Hängeleuchte; Stahl, schwarz
luminaire en suspension; acier, noir

H 1500, Ø 330



E27 3x 40W



9 002759 986636



98662 POZUETA

pendant light; steel, black
Hängeleuchte; Stahl, schwarz
luminaire en suspension; acier, noir

L 840, B 65, H 1100



E27 3x 40W



9 002759 986629





98346



98347

98346 BOCADELLA

pendant light; steel, black
Hängeleuchte; Stahl, schwarz
luminaire en suspension; acier, noir

H 1100, Ø 640



E27



9x 60W



9 002759 983468

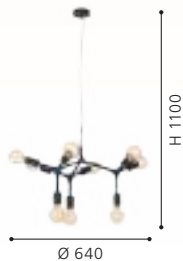

Ø 640

98347 BOCADELLA

pendant light; steel, black
Hängeleuchte; Stahl, schwarz
luminaire en suspension; acier, noir

H 1100, Ø 920



E27



12x 60W



9 002759 983475

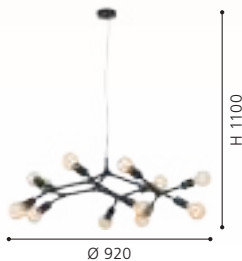

Ø 920

98909 MEZZANA

pendant light; steel, black
Hängeleuchte; Stahl, schwarz
luminaire en suspension; acier, noir

L 650, B 650, H 1100



E27



8x 40W



9 002759 989095



L 650



98909



98017



98016

99811

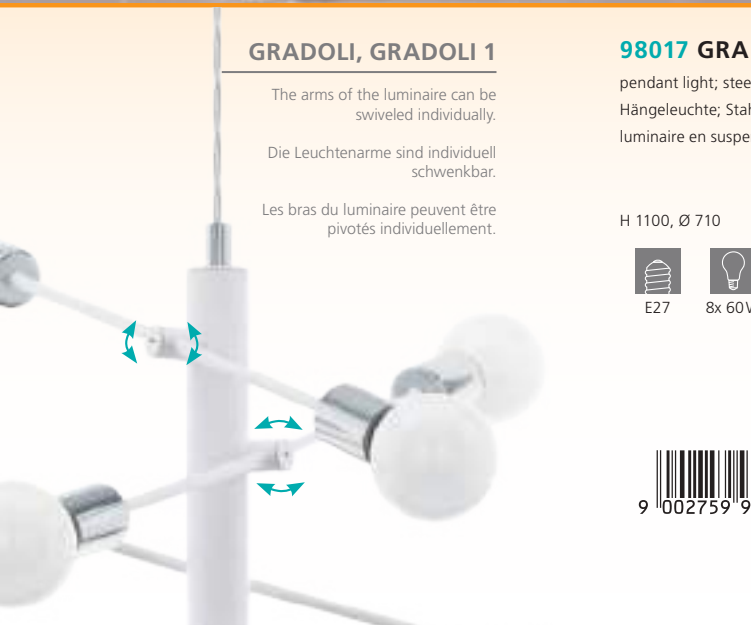

GRADOLI, GRADOLI 1

The arms of the luminaire can be swiveled individually.

Die Leuchtenarme sind individuell schwenkbar.

Les bras du luminaire peuvent être pivotés individuellement.

98017 GRADOLI

pendant light; steel, white, chrome
Hängeleuchte; Stahl, weiss, chrom
luminaire en suspension; acier, blanc, chrome

H 1100, Ø 710

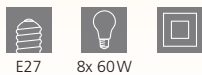

E27 8x 60W



9 002759 980177

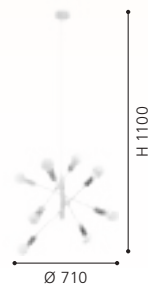

98016 GRADOLI

pendant light; steel, white, chrome
Hängeleuchte; Stahl, weiss, chrom
luminaire en suspension; acier, blanc, chrome

H 1100, Ø 550



E27 6x 60W



9 002759 980160

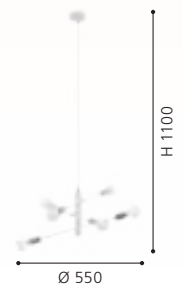



98835



MANIZALES



98834

99811 GRADOLI 1

pendant light; steel, brushed brass
Hängeleuchte; Stahl, messing-gebürstet
luminaire en suspension; acier, laiton brossé

H 1100, Ø 710

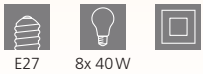

E27 8x 40W



9 002759 998110



98835 MANIZALES

pendant light; steel, brushed brass
Hängeleuchte; Stahl, messing-gebürstet
luminaire en suspension; acier, laiton brossé

L 1010, B 50, H 1100



E27 3x 40W



9 002759 988357



98834 MANIZALES

pendant light; steel, brushed brass
Hängeleuchte; Stahl, messing-gebürstet
luminaire en suspension; acier, laiton brossé

L 250, B 105, H 1100



E27 1x 40W



9 002759 988340

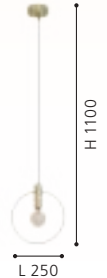



900399



97733

LED

900399 CUMIOLE

pendant light; steel, gold-coloured
 Hängeleuchte; Stahl, goldfarben
 luminaire en suspension; acier, or

L 780, B 150, H 1100



E27



3x 40W



9 008606 243754

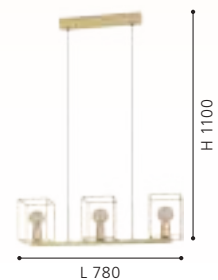



97734



98858

97733 MONTEBALDO

pendant light; steel, black, gold
Hängeleuchte; Stahl, schwarz, gold
luminaire en suspension; acier, noir, or

L 100, B 100, H 1100

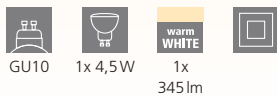

97734 MONTEBALDO

pendant light; steel, black, gold
Hängeleuchte; Stahl, schwarz, gold
luminaire en suspension; acier, noir, or

L 850, B 100, H 1100

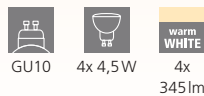

98858 BITACHITO

pendant light; steel, black, brass
Hängeleuchte; Stahl, schwarz, messing
luminaire en suspension; acier, noir, laiton

L 930, B 55, H 1100

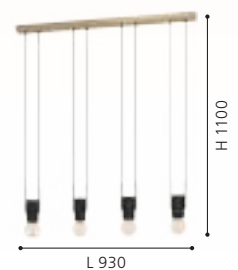



97604

LED

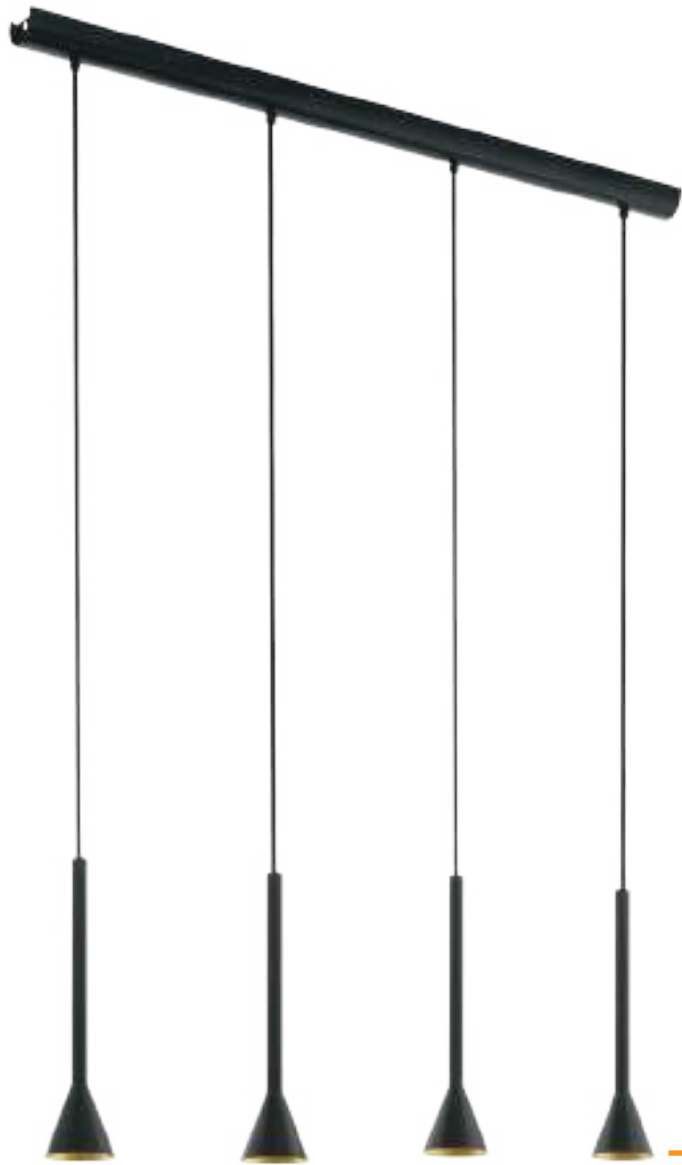

97605

LED



97604 CORTADERAS

pendant light; steel, black, gold
Hängeleuchte; Stahl, schwarz, gold
luminaire en suspension; acier, noir, or

H 1500, Ø 95



GU10



1x 4,8W



1x

400lm



9 002759 976040



97605 CORTADERAS

pendant light; steel, black, gold
Hängeleuchte; Stahl, schwarz, gold
luminaire en suspension; acier, noir, or

L 1130, B 85, H 1500



GU10



4x 4,8W



4x

400lm



9 002759 976057

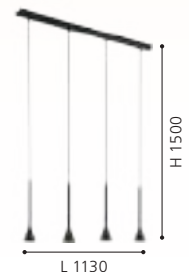



900977



900976



900975

900975, 900976, 900977



These luminaires have a mains plug. The cable routing (total cable length 5.5 m) of these luminaires is individual, the fastening clips required for this are included in the scope of delivery.

Diese Leuchten haben einen Netzstecker. Die Kabelführung (Gesamtkabellänge 5,5 m) dieser Leuchten ist individuell, die dafür benötigten Befestigungsclips sind im Lieferumfang enthalten.

Ces luminaires sont équipés d'une fiche secteur. Le guidage du câble (longueur totale du câble : 5,5 m) de ces luminaires est individuel, les clips de fixation nécessaires sont compris dans la livraison.

900977 RONDO 3

pendant light; steel, plastic, black / matte-opal glass, white
Hängeleuchte; Stahl, Kunststoff, schwarz / Glas opal-matt, weiss
luminaire en suspension; acier, plastique, noir / verre opale mat, blanc

L 200, H 1420, A 400



E27 1x 40W

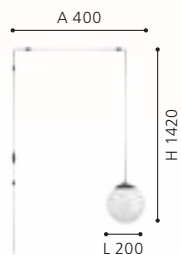

9 008606 282791

900976 PINETINA

pendant light; steel, black
Hängeleuchte; Stahl, schwarz
luminaire en suspension; acier, noir

L 45, H 1280, A 400



E27 1x 40W

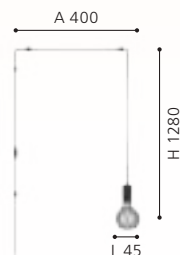

9 008606 281831

900975 NARICES

pendant light; steel, brushed brass, black
Hängeleuchte; Stahl, messing-gebürstet, schwarz
luminaire en suspension; acier, laiton brossé, noir

L 180, H 1420, A 400



E27 1x 40W

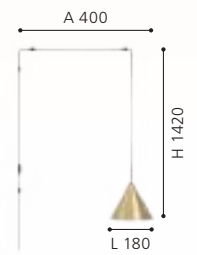

9 008606 281824



900401



900402



900401 SARONA

pendant light; steel, black, gold
 Hängeleuchte; Stahl, schwarz, gold
 luminaire en suspension; acier, noir, or

H 1100, Ø 210

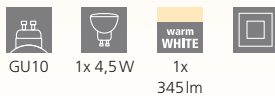

GU10 1x 4,5W 1x 345lm



9 008606 243761



900402 SARONA

pendant light; steel, black, gold
 Hängeleuchte; Stahl, schwarz, gold
 luminaire en suspension; acier, noir, or

L 910, B 50, H 1100



GU10 3x 4,5W 3x 345lm



9 008606 243778

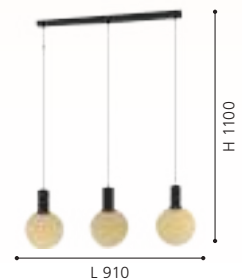



99531



99532

99531 LOBATIA

pendant light; steel, wood, black / terrazzo, grey, white
 Hängeleuchte; Stahl, Holz, schwarz / Terrazzo, grau, weiss
 luminaire en suspension; acier, bois, noir / terrazzo, gris, blanc

H 1100, Ø 105



E27



1x 40W



9 002759 995317

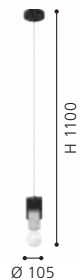

99532 LOBATIA

pendant light; steel, wood, black / terrazzo, grey, white
 Hängeleuchte; Stahl, Holz, schwarz / Terrazzo, grau, weiss
 luminaire en suspension; acier, bois, noir / terrazzo, gris, blanc

L 925, B 55, H 1100



E27



4x 40W



9 002759 995324

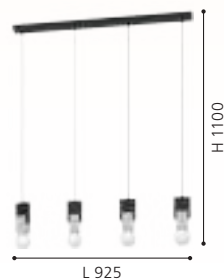

LOBATIA



95522



95523

95522 SILVARES

pendant light; steel, grey / concrete, grey
 Hängeleuchte; Stahl, grau / Beton, grau
 luminaire en suspension; acier, gris / béton, gris

H 1100, Ø 110

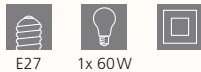

95523 SILVARES

pendant light; steel, grey / concrete, grey
 Hängeleuchte; Stahl, grau / Beton, grau
 luminaire en suspension; acier, gris / béton, gris

H 1500, Ø 250





95525



95526

95525 TAREGA

pendant light; steel, grey / wood, concrete, brown, grey
 Hängeleuchte; Stahl, grau / Holz, Beton, braun, grau
 luminaire en suspension; acier, gris / bois, béton, marron, gris

H 1100, Ø 150



95526 TAREGA

pendant light; steel, grey / wood, concrete, brown, grey
 Hängeleuchte; Stahl, grau / Holz, Beton, braun, grau
 luminaire en suspension; acier, gris / bois, béton, marron, gris

H 1500, Ø 250





99464



GATUELA 1

The lamp heads can be swiveled.
Die Leuchtenköpfe sind schwenkbar.
Les têtes de lampe peuvent être pivotées.

99464 GATUELA 1

pendant light; steel, black
Hängeleuchte; Stahl, schwarz
luminaire en suspension; acier, noir

L 1160, B 190, H 1100



E14



6x 25W



9 002759 994648

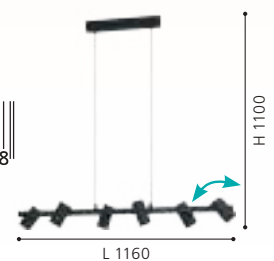

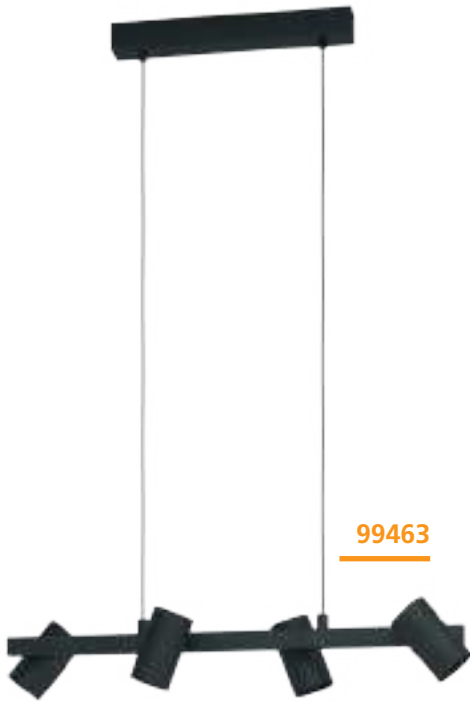

99463

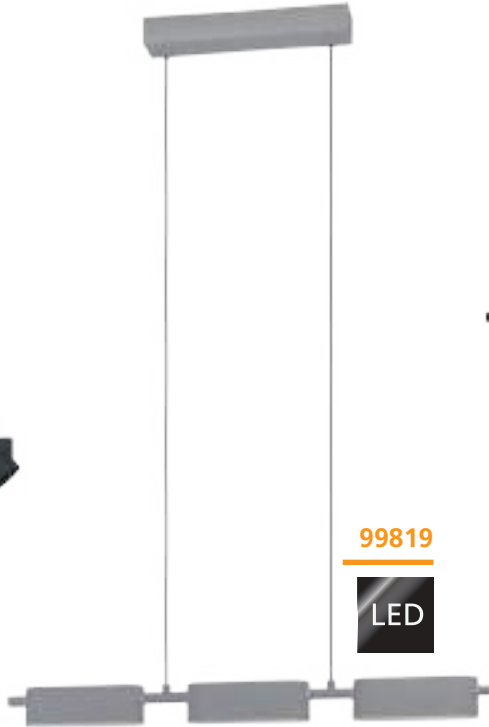

99819

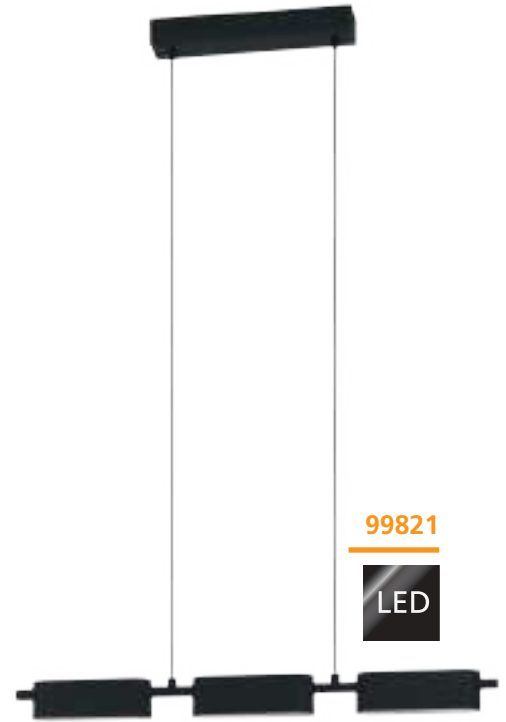

99821



99463 GATUELA 1

pendant light; steel, black
Hängeleuchte; Stahl, schwarz
luminaire en suspension; acier, noir

L 760, B 190, H 1100

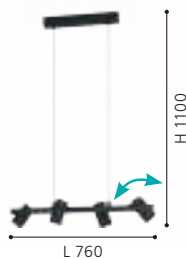

99819 ROVIRA

pendant light; aluminium, steel, silver / plastic, white
Hängeleuchte; Alu, Stahl, silber / Kunststoff, weiss
luminaire en suspension; aluminium, acier, argent / plastique, blanc

L 770, B 50, H 1100

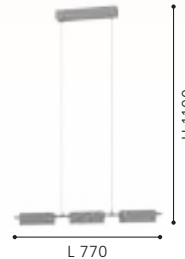

99821 ROVIRA

pendant light; aluminium, steel, black / plastic, white
Hängeleuchte; Alu, Stahl, schwarz / Kunststoff, weiss
luminaire en suspension; aluminium, acier, noir / plastique, blanc

L 770, B 50, H 1100

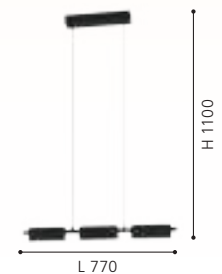



98492 AMONTILLADO

pendant light; aluminium, steel, black / plastic, white
 Hängeleuchte; Alu, Stahl, schwarz / Kunststoff, weiss
 luminaire en suspension; aluminium, acier, noir / plastique, blanc

L 1160, B 85, H 1100



2x 13,5W 3500lm



9 002759 984922

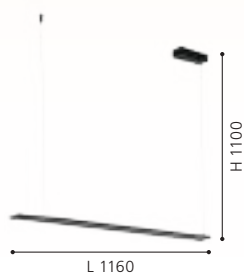

99599 CAMBULOS

pendant light; steel, black / plastic, white
 Hängeleuchte; Stahl, schwarz / Kunststoff, weiss
 luminaire en suspension; acier, noir / plastique, blanc

L 935, B 105, H 1100



2x 17W 4300lm



9 002759 995997



98495 SPADAFORA

pendant light; aluminium, steel, black / plastic, clear, white
 Hängeleuchte; Alu, Stahl, schwarz / Kunststoff, klar, weiss
 luminaire en suspension; aluminium, acier, noir / plastique, transparent, blanc

L 1160, B 80, H 1100



2x 7,5W 2000lm



9 002759 984953

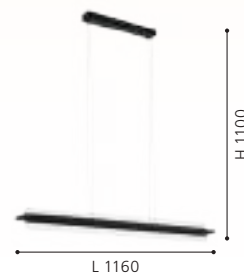



98836



98836 ERMUA

pendant light; steel, wood, black, brown / plastic, white
 Hängeleuchte; Stahl, Holz, schwarz, braun / Kunststoff, weiss
 luminaire en suspension; acier, bois, noir, marron / plastique, blanc

L 1000, B 165, H 1100



27W 3850lm

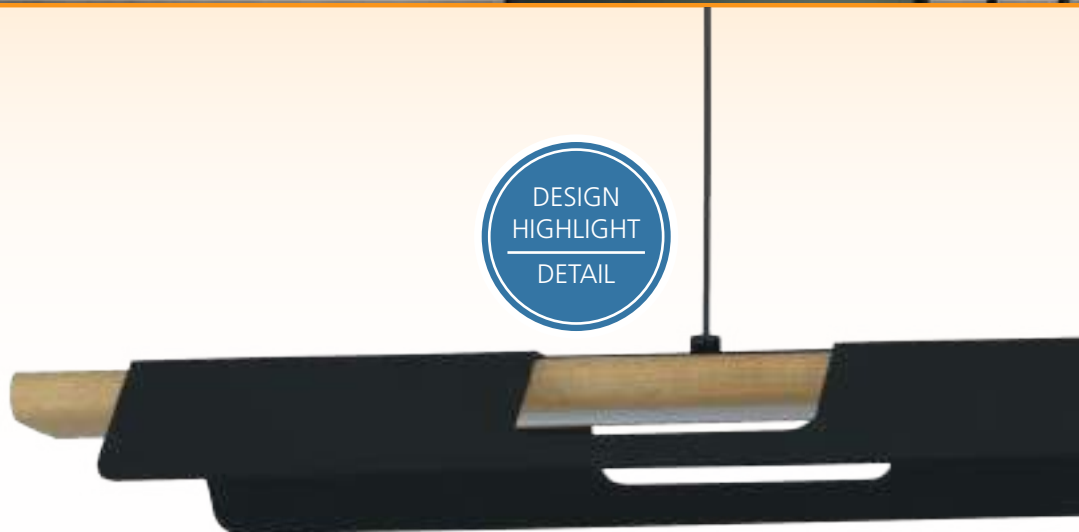
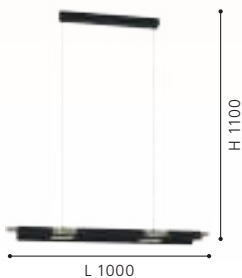

900175

LED





900174

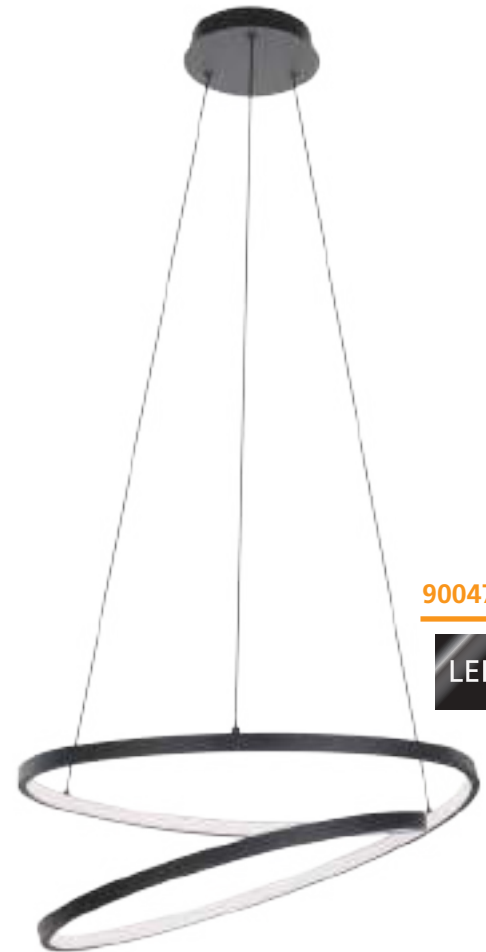

900472



900175 LISCIANA

pendant light; aluminium, steel, wood, grey / plastic, white
 Hängeleuchte; Alu, Stahl, Holz, grau / Kunststoff, weiss
 luminaire en suspension; aluminium, acier, bois, gris / plastique, blanc

L 1260, B 35, H 1100



22W 2500lm



9 008606 238088

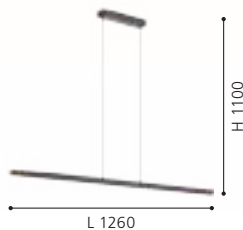

900174 LISCIANA

pendant light; aluminium, steel, wood, grey / plastic, white
 Hängeleuchte; Alu, Stahl, Holz, grau / Kunststoff, weiss
 luminaire en suspension; aluminium, acier, bois, gris / plastique, blanc

L 875, B 35, H 1100



18W 2000lm



9 008606 238071

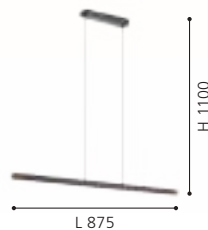

900472 RUOTALE

pendant light; aluminium, steel, black / plastic, white
 Hängeleuchte; Alu, Stahl, schwarz / Kunststoff, weiss
 luminaire en suspension; aluminium, acier, noir / plastique, blanc

H 1500, Ø 550



37W 4800lm



9 008606 239931





99818

LED



99249

LED

99818 SALITRE

pendant light; aluminium, black / plastic, white
 Hängeleuchte; Alu, schwarz / Kunststoff, weiss
 luminaire en suspension; aluminium, noir / plastique, blanc

H 1200, Ø 730



29W 4000lm

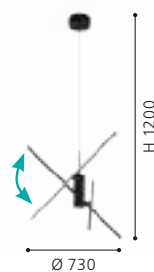

99249 CORREDERA

pendant light; steel, black / plastic, white
 Hängeleuchte; Stahl, schwarz / Kunststoff, weiss
 luminaire en suspension; acier, noir / plastique, blanc

H 1200, Ø 500



34W 5100lm

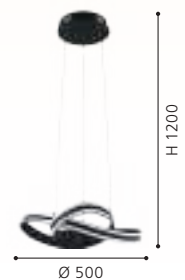



99697

LED



99698

LED

99697 BUTRANO

pendant light; steel, black, silver
 Hängeleuchte; Stahl, schwarz, silber
 luminaire en suspension; acier, noir, argent

L 55, B 55, H 1100

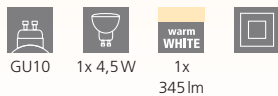

GU10 1x 4,5W 1x 345lm



9 002759 996970



99698 BUTRANO

pendant light; steel, black, silver
 Hängeleuchte; Stahl, schwarz, silber
 luminaire en suspension; acier, noir, argent

L 770, B 55, H 1100



GU10 3x 4,5W 3x 345lm



9 002759 996987

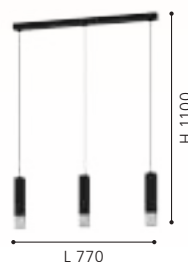



RAZONI | RAZONI 1

92252 RAZONI

pendant light; steel, black / satin glass, steel, black, white
 Hängeleuchte; Stahl, schwarz / Glas satiniert, Stahl, schwarz, weiss
 luminaire en suspension; acier, noir / verre satiné, acier, noir, blanc

H 1300, Ø 190



900828 RAZONI 1

pendant light; steel, black / steel, glass, black, white
 Hängeleuchte; Stahl, schwarz / Stahl, Glas, schwarz, weiss
 luminaire en suspension; acier, noir / acier, verre, noir, blanc

H 1100, Ø 425



94389 RAZONI

pendant light; steel, black / satin glass, steel, black, white
 Hängeleuchte; Stahl, schwarz / Glas satiniert, Stahl, schwarz, weiss
 luminaire en suspension; acier, noir / verre satiné, acier, noir, blanc

L 990, B 190, H 1100

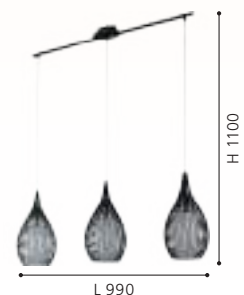



92251

900829

94388

92251 RAZONI

pendant light; steel, white / satin glass, steel, white
 Hängeleuchte; Stahl, weiss / Glas satiniert, Stahl, weiss
 luminaire en suspension; acier, blanc / verre satiné, acier, blanc

H 1300, Ø 190



E27 1x 60W



9 002759 922511



900829 RAZONI 1

pendant light; steel, white / steel, glass, white
 Hängeleuchte; Stahl, weiss / Stahl, Glas, weiss
 luminaire en suspension; acier, blanc / acier, verre, blanc

H 1100, Ø 425



E27 1x 40W



9 008606 267965

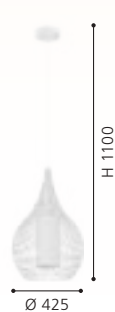

94388 RAZONI

pendant light; steel, white / satin glass, steel, white
 Hängeleuchte; Stahl, weiss / Glas satiniert, Stahl, weiss
 luminaire en suspension; acier, blanc / verre satiné, acier, blanc

L 990, B 190, H 1100



E27 3x 60W



9 002759 943882

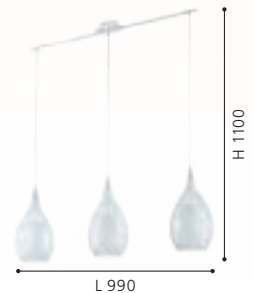



97066



98689

97066 ESTEVAU

pendant light; steel, dark brown
 Hängeleuchte; Stahl, dunkelbraun
 luminaire en suspension; acier, marron foncé

L 975, B 145, H 1100



E27



4x 60W



9 002759 970666



98689 OKINZURI

pendant light; steel, brass
 Hängeleuchte; Stahl, messing
 luminaire en suspension; acier, laiton

H 1100, Ø 450



E27



1x 60W



9 002759 986896



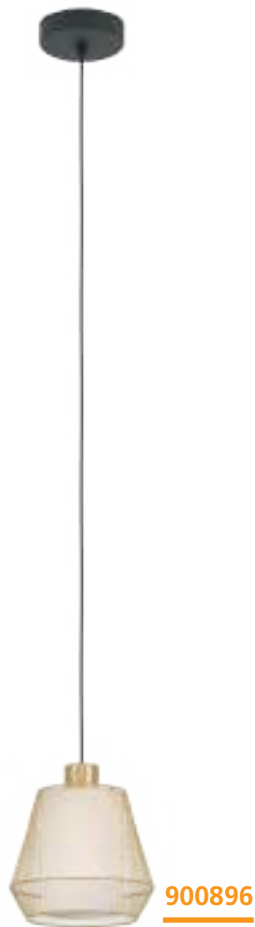

900896



900896



900897

900896 CIUADELA

pendant light; steel, black / steel, fabric, brushed brass, white
 Hängeleuchte; Stahl, schwarz / Stahl, Textil, messing-gebürstet, weiss
 luminaire en suspension; acier, noir / acier, tissu, laiton brossé, blanc

H 1100, Ø 180



E27 1x 40W



9 008606 274673



900897 CIUADELA

pendant light; steel, black / steel, fabric, brushed brass, white
 Hängeleuchte; Stahl, schwarz / Stahl, Textil, messing-gebürstet, weiss
 luminaire en suspension; acier, noir / acier, tissu, laiton brossé, blanc

L 880, B 180, H 1100



E27 3x 40W



9 008606 274680





99635 | 99636



99634



99636

DESIGN
HIGHLIGHT
DETAIL



99634 MASETA

pendant light; steel, black / smoked glass, black-transparent
Hängeleuchte; Stahl, schwarz / Rauchglas, schwarz-transparent
luminaire en suspension; acier, noir / verre fumé, noir transparent

L 930, B 225, H 1100



E27

3x 40W



9 002759 996345



99636 MASETA

pendant light; steel, gold-coloured / matte-opal glass, white
Hängeleuchte; Stahl, goldfarben / Glas opal-matt, weiss
luminaire en suspension; acier, or / verre opale mat, blanc

L 930, B 225, H 1100



E27

3x 40W



9 002759 996369



99635 MASETA

pendant light; steel, gold-coloured / matte-opal glass, white
Hängeleuchte; Stahl, goldfarben / Glas opal-matt, weiss
luminaire en suspension; acier, or / verre opale mat, blanc

H 1100, Ø 225



E27

1x 40W



9 002759 996352





99635



99633 | 99634

99633 MASETA

pendant light; steel, black / smoked glass, black-transparent
Hängeleuchte; Stahl, schwarz / Rauchglas, schwarz-transparent
luminaire en suspension; acier, noir / verre fumé, noir transparent

H 1100, Ø 225



E27



1x 40W

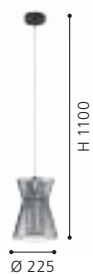

99633



99705 FLORESTA

pendant light; steel, black / glass vaporized, black-transparent
 Hängeleuchte; Stahl, schwarz / Glas bedampft, schwarz-transparent
 luminaire en suspension; acier, noir / verre vaporisé, noir transparent

H 1100, Ø 195



99706 FLORESTA

pendant light; steel, black / glass vaporized, black-transparent
 Hängeleuchte; Stahl, schwarz / Glas bedampft, schwarz-transparent
 luminaire en suspension; acier, noir / verre vaporisé, noir transparent

L 890, B 190, H 1100



99707 ZOCABON

pendant light; steel, black / glass, clear
 Hängeleuchte; Stahl, schwarz / Glas, klar
 luminaire en suspension; acier, noir / verre, transparent

L 815, B 110, H 1100

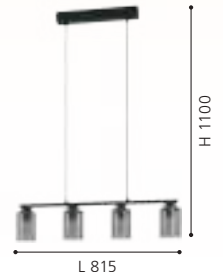

99707





99618



99619



99618 MULEGES

pendant light; steel, black / matte-opal glass, white
Hängeleuchte; Stahl, schwarz / Glas opal-matt, weiss
luminaire en suspension; acier, noir / verre opale mat, blanc

H 1100, Ø 160



99619 MULEGES

pendant light; steel, black / matte-opal glass, white
Hängeleuchte; Stahl, schwarz / Glas opal-matt, weiss
luminaire en suspension; acier, noir / verre opale mat, blanc

L 960, B 160, H 1100

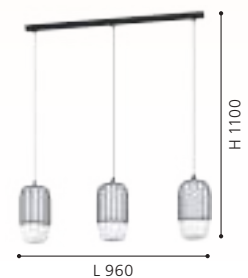



900867

900866

900867 TERRAROSA

pendant light; steel, sandy / fabric, white
 Hängeleuchte; Stahl, sandfarben / Textil, weiss
 luminaire en suspension; acier, couleur sable / tissu, blanc

H 1100, Ø 285



900866 TERRAROSA

pendant light; steel, sandy / fabric, white
 Hängeleuchte; Stahl, sandfarben / Textil, weiss
 luminaire en suspension; acier, couleur sable / tissu, blanc

H 1100, Ø 240





99661



99662

99661 CURASAO

pendant light; steel, black / steel, fabric, black, gold
 Hängeleuchte; Stahl, schwarz / Stahl, Textil, schwarz, gold
 luminaire en suspension; acier, noir / acier, tissu, noir, or

H 1100, Ø 335



99662 CURASAO

pendant light; steel, black / steel, fabric, black, gold
 Hängeleuchte; Stahl, schwarz / Stahl, Textil, schwarz, gold
 luminaire en suspension; acier, noir / acier, tissu, noir, or

L 995, B 235, H 1100

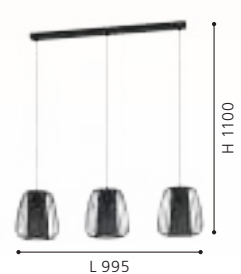

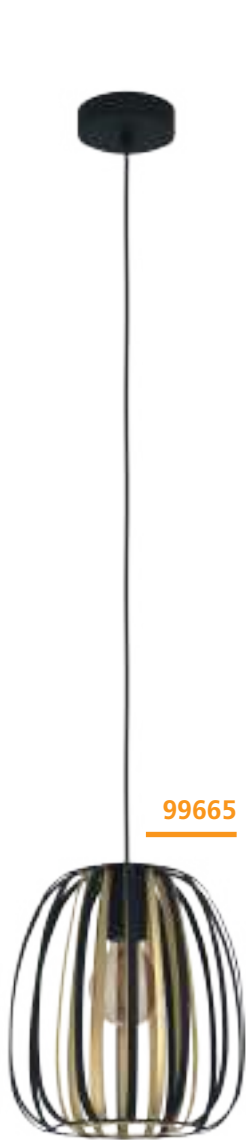

99665

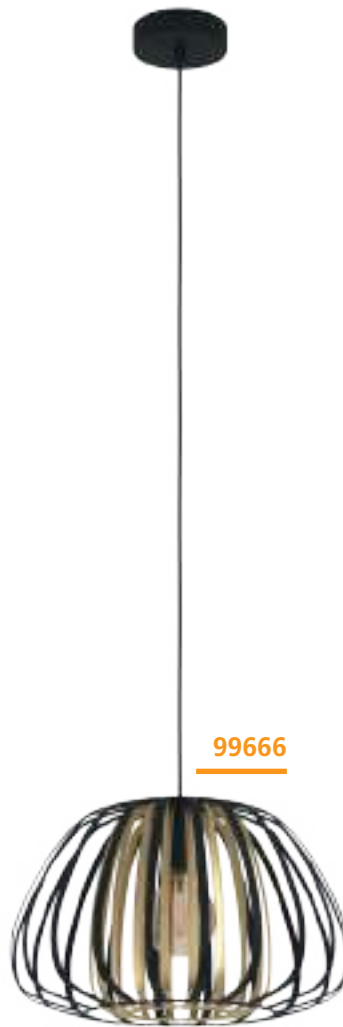

99666



99665 ENCINITOS

pendant light; steel, black, gold
Hängeleuchte; Stahl, schwarz, gold
luminaire en suspension; acier, noir, or

H 1100, Ø 255



E27 1x 40W



9 002759 996659



Ø 255

99666 ENCINITOS

pendant light; steel, black, gold
Hängeleuchte; Stahl, schwarz, gold
luminaire en suspension; acier, noir, or

H 1100, Ø 375



E27 1x 40W



9 002759 996666

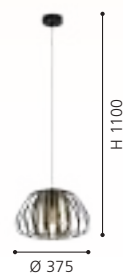

Ø 375



99694

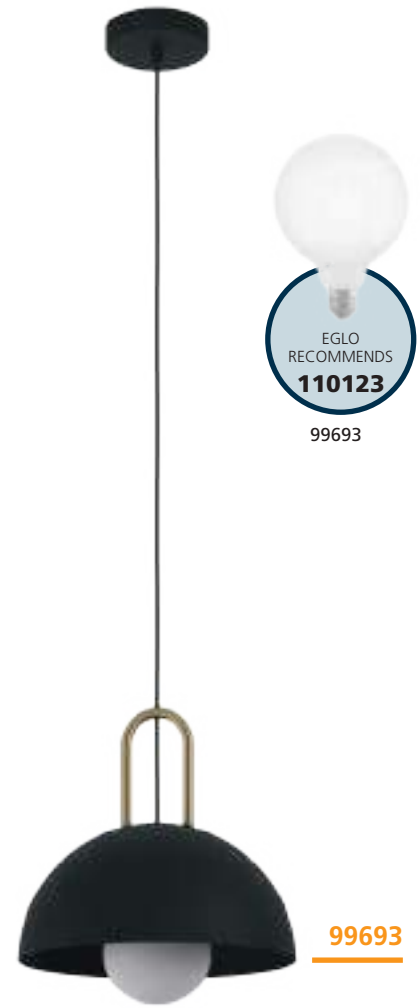

99693

99693

99694 CALMANERA

pendant light; steel, black, brass
 Hängeleuchte; Stahl, schwarz, messing
 luminaire en suspension; acier, noir, laiton

L 900, B 200, H 1100



9 002759 996949



99693 CALMANERA

pendant light; steel, black, brass
 Hängeleuchte; Stahl, schwarz, messing
 luminaire en suspension; acier, noir, laiton

H 1100, Ø 325



9 002759 996932





99695 | 99696

99696



99695

99696 CALMANERA

pendant light; steel, white, brass
 Hängeleuchte; Stahl, weiss, messing
 luminaire en suspension; acier, blanc, laiton

L 900, B 200, H 1100



9 002759 996963

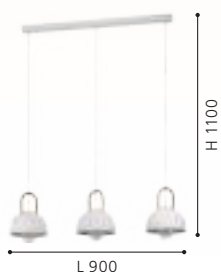

99695 CALMANERA

pendant light; steel, white, brass
 Hängeleuchte; Stahl, weiss, messing
 luminaire en suspension; acier, blanc, laiton

H 1100, Ø 325



9 002759 996956

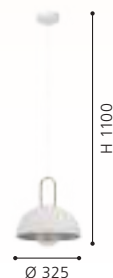



900429

900429 VALDIOLA

pendant light; steel, sandy, brushed brass
 Hängeleuchte; Stahl, sandfarben, messing-gebürstet
 luminaire en suspension; acier, couleur sable, laiton brossé

H 1100, Ø 360



E27 1x 40W



9 008606 240562

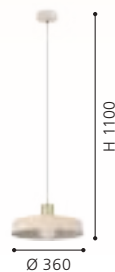

H 1100

Ø 360

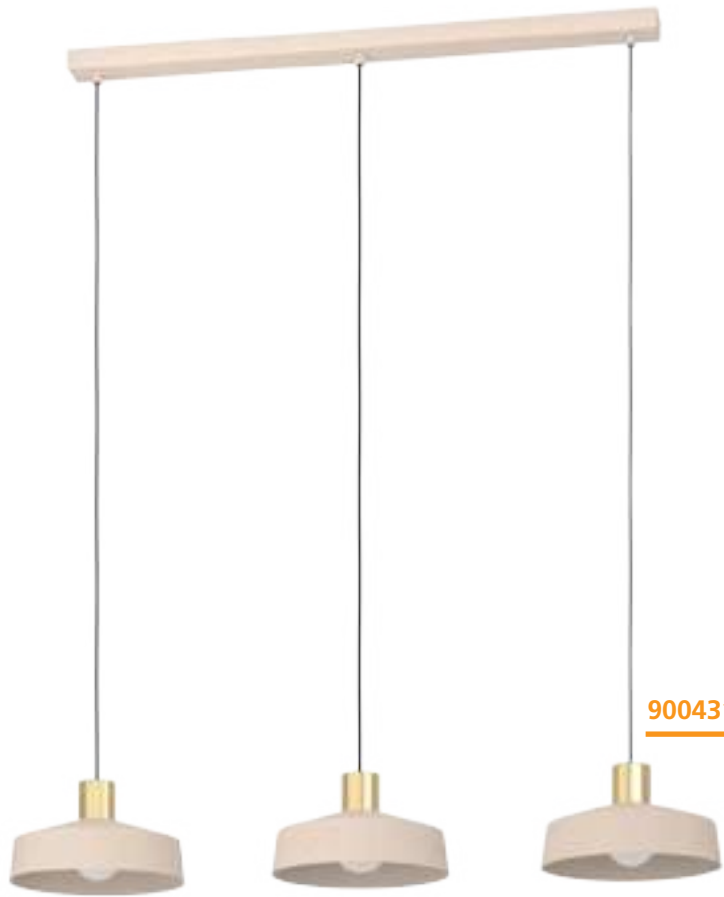

900431

900431 VALDIOLA

pendant light; steel, sandy, brushed brass
 Hängeleuchte; Stahl, sandfarben, messing-gebürstet
 luminaire en suspension; acier, couleur sable, laiton brossé

L 930, B 230, H 1100



E27 3x 40W



9 008606 240579

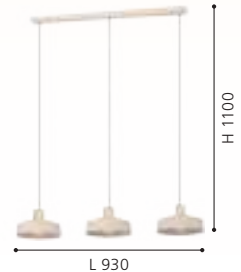

H 1100

L 930

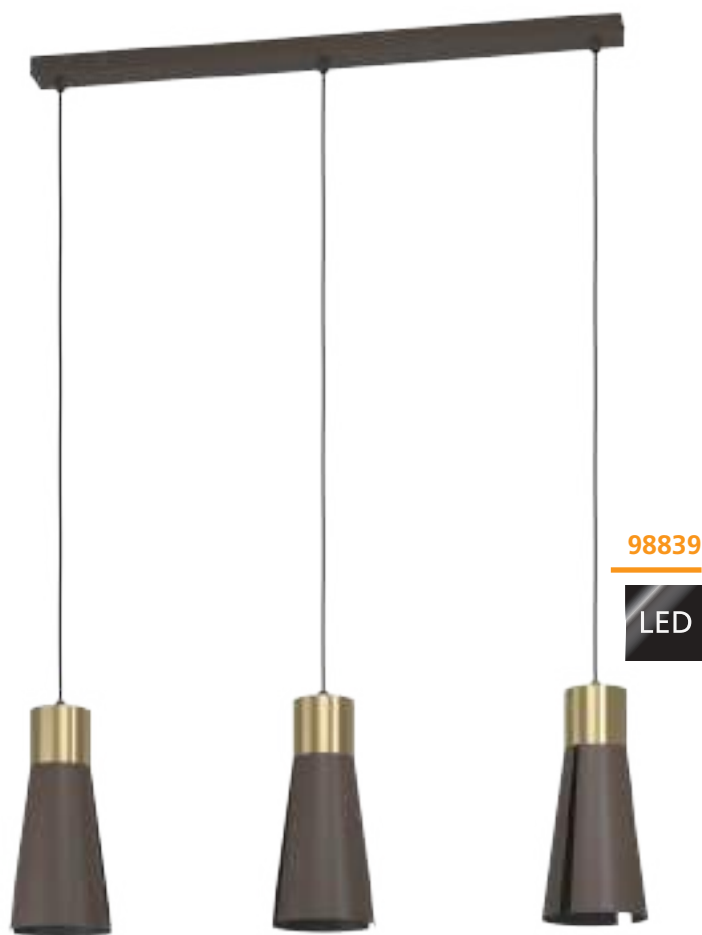

98839

LED



98838

LED

98839 LOSALOMAS

pendant light; steel, mocha-coloured, brushed brass
Hängeleuchte; Stahl, Mokkafarben, messing-gebürstet
luminaire en suspension; acier, café, laiton brossé

L 835, B 135, H 1100

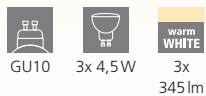

GU10 3x 4,5W 3x 345lm



9 002759 988395



L 835

H 1100

98838 LOSALOMAS

pendant light; steel, mocha-coloured, brushed brass
Hängeleuchte; Stahl, Mokkafarben, messing-gebürstet
luminaire en suspension; acier, café, laiton brossé

H 1100, Ø 135

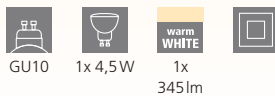

GU10 1x 4,5W 1x 345lm



9 002759 988388

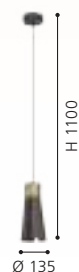

Ø 135

H 1100



900425 BOLIVIA

pendant light; steel, black / steel, black, sandy
 Hängeleuchte; Stahl, schwarz / Stahl, schwarz, sandfarben
 luminaire en suspension; acier, noir / acier, noir, couleur sable

H 1100, Ø 180



900426 BOLIVIA

pendant light; steel, black / steel, black, sandy
 Hängeleuchte; Stahl, schwarz / Stahl, schwarz, sandfarben
 luminaire en suspension; acier, noir / acier, noir, couleur sable

L 880, B 180, H 1100



900143 CAMBAITO

pendant light; steel, sandy
 Hängeleuchte; Stahl, sandfarben
 luminaire en suspension; acier, couleur sable

L 895, B 195, H 1100

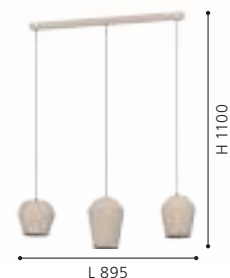



900158



900159

900158 CAMASCA

pendant light; steel, black
Hängeleuchte; Stahl, schwarz
luminaire en suspension; acier, noir

H 500 - 1100, Ø 280

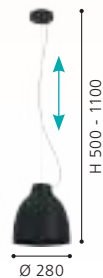

900159 CAMASCA

pendant light; steel, taupe
Hängeleuchte; Stahl, taupe
luminaire en suspension; acier, taupe

H 500 - 1100, Ø 280



CAMASCA

These luminaires are height adjustable.
Diese Leuchten sind höhenverstellbar.
Ces luminaires sont réglables en hauteur.





900836

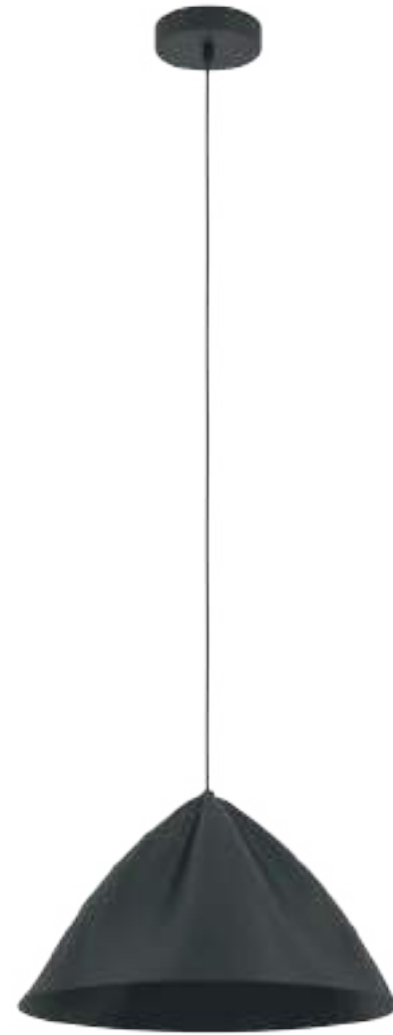

900835

900836 PODERE

pendant light; steel, sandy
 Hängeleuchte; Stahl, sandfarben
 luminaire en suspension; acier, couleur sable

H 1100, Ø 425



E27 1x 40W



900835 PODERE

pendant light; steel, black
 Hängeleuchte; Stahl, schwarz
 luminaire en suspension; acier, noir

H 1100, Ø 425



E27 1x 40W





900346 GAZZOLA

pendant light; steel, mocha-coloured, sandy
 Hängeleuchte; Stahl, Mokka, Sandfarben
 luminaire en suspension; acier, café, couleur sable

L 910, B 150, H 1100

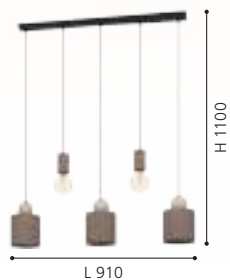



99439



99438



99439 SEGEZIA

pendant light; steel, mocha-coloured / steel, mocha colour, gold
Hängeleuchte; Stahl, Mokkafarben / Stahl, Mokka, gold
luminaire en suspension; acier, café / acier, Mokka, or

H 1100, Ø 350



E27 1x 40W



9 002759 994396



H 1100

Ø 350

99438 SEGEZIA

pendant light; steel, mocha-coloured / steel, mocha colour, gold
Hängeleuchte; Stahl, Mokkafarben / Stahl, Mokka, gold
luminaire en suspension; acier, café / acier, Mokka, or

L 880, B 180, H 1100



E27 3x 40W



9 002759 994389



H 1100

L 880



98353 RAMON

pendant light; steel, black / film, white
 Hängeleuchte; Stahl, schwarz / Folie, weiss
 luminaire en suspension; acier, noir / film, blanc

L 860, B 160, H 1100

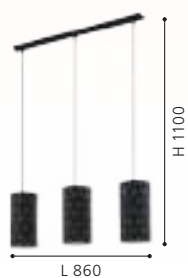

98071 CAMASTRA

pendant light; steel, black, gold
 Hängeleuchte; Stahl, schwarz, gold
 luminaire en suspension; acier, noir, or

H 1100, Ø 225

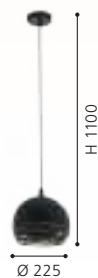

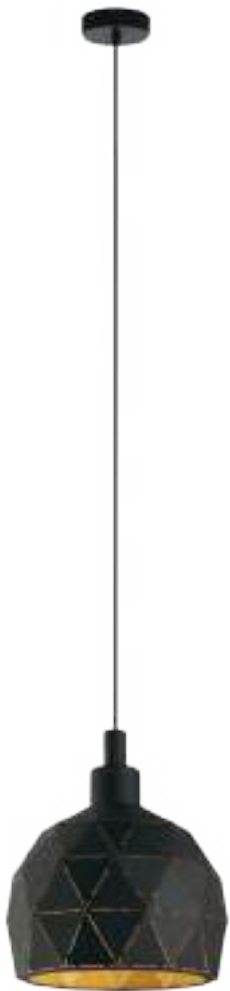

33345



97845



97841

33345 ROCCAFORTE

pendant light; steel, black, gold
Hängeleuchte; Stahl, schwarz, gold
luminaire en suspension; acier, noir, or

H 1100, Ø 170



E14 1x 40W



9 002759 333454

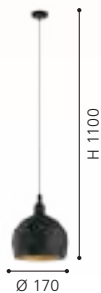

97845 ROCCAFORTE

pendant light; steel, black, gold
Hängeleuchte; Stahl, schwarz, gold
luminaire en suspension; acier, noir, or

H 1100, Ø 300



E27 1x 60W



9 002759 978457



97841 ROCCAFORTE

pendant light; steel, black, gold
Hängeleuchte; Stahl, schwarz, gold
luminaire en suspension; acier, noir, or

H 1100, Ø 400



E27 1x 60W



9 002759 978419





97846

97846 ROCCAFORTE

pendant light; steel, black, gold
Hängeleuchte; Stahl, schwarz, gold
luminaire en suspension; acier, noir, or

L 750, B 170, H 1100



E14



3x 40W



9 002759 978464





33344



97854

33344 ROCCAFORTE

pendant light; steel, white
Hängeleuchte; Stahl, weiss
luminaire en suspension; acier, blanc

H 1100, Ø 170



E14



1x 40W



9 002759 333447





97855

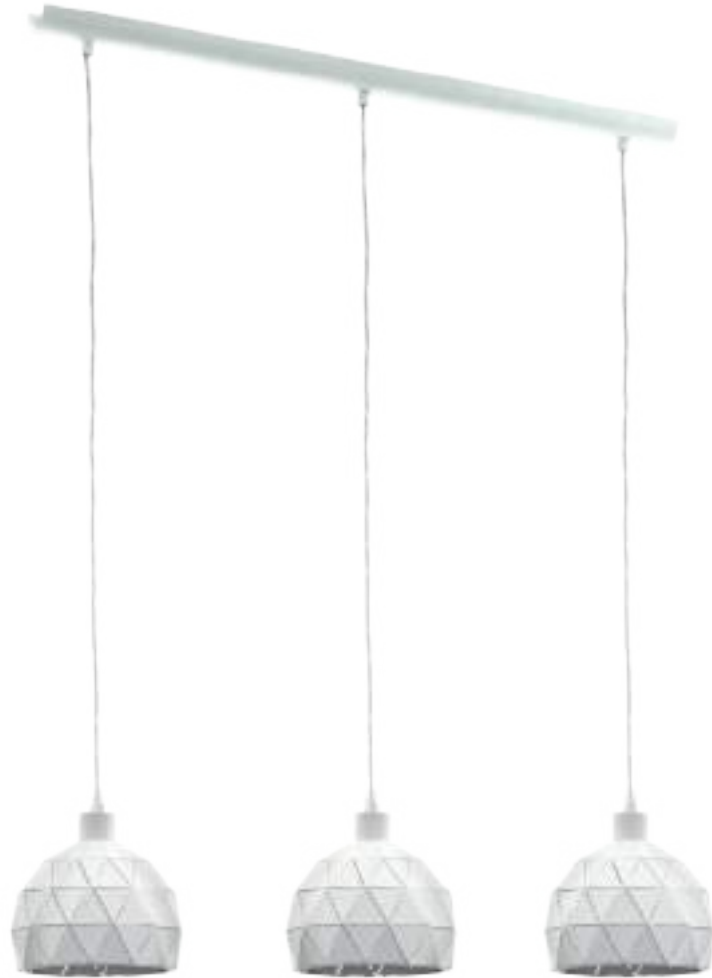

97857

97854 ROCCAFORTE

pendant light; steel, white
Hängeleuchte; Stahl, weiss
luminaire en suspension; acier, blanc

H 1100, Ø 300



9 002759 978549

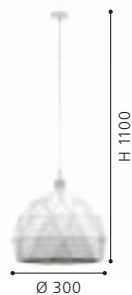

97855 ROCCAFORTE

pendant light; steel, white
Hängeleuchte; Stahl, weiss
luminaire en suspension; acier, blanc

H 1100, Ø 400



9 002759 978556



97857 ROCCAFORTE

pendant light; steel, white
Hängeleuchte; Stahl, weiss
luminaire en suspension; acier, blanc

L 750, B 170, H 1100



9 002759 978570

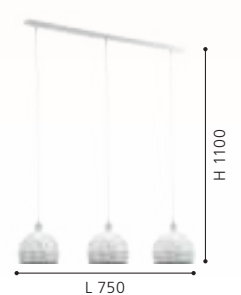



93373



93374



93373 CAMPILO

pendant light; plastic, white / paper threads, white
 Hängeleuchte; Kunststoff, weiss / Papierfäden, weiss
 luminaire en suspension; plastique, blanc / fils de papier, blanc

H 1100, Ø 450

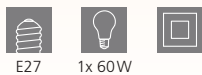

9 002759 933739



93374 CAMPILO

pendant light; plastic, white / paper threads, beige
 Hängeleuchte; Kunststoff, weiss / Papierfäden, beige
 luminaire en suspension; plastique, blanc / fils de papier, beige

H 1100, Ø 450



9 002759 933746





95385



95383

95385 OBREGON

pendant light; steel, brown, cream, oak
 Hängeleuchte; Stahl, braun, creme, eiche
 luminaire en suspension; acier, marron, crème, chêne

H 1100, Ø 350

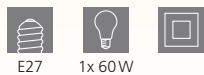

E27 1x 60W



9 002759 953850

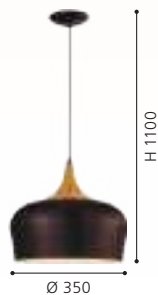

95383 OBREGON

pendant light; steel, cream, oak
 Hängeleuchte; Stahl, creme, eiche
 luminaire en suspension; acier, crème, chêne

H 1100, Ø 350



E27 1x 60W



9 002759 953836





900161

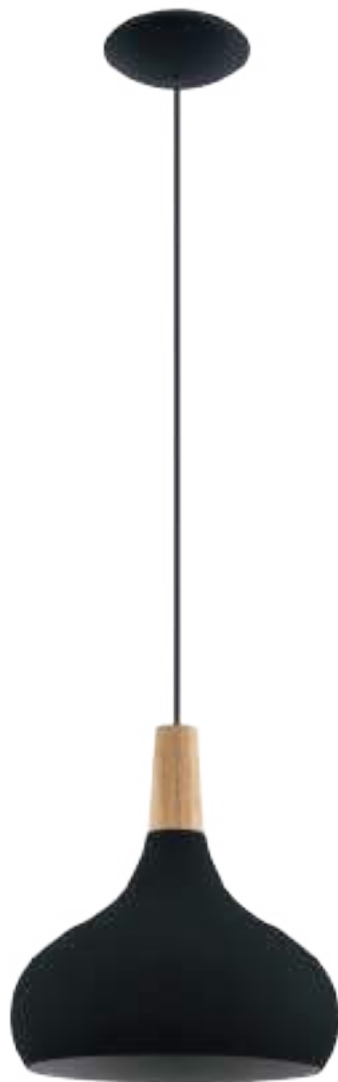

900162



900163



900161 SABINAR

pendant light; steel, wood, black, brown
Hängeleuchte; Stahl, Holz, schwarz, braun
luminaire en suspension; acier, bois, noir, marron

H 1100, Ø 180



E27



1x 40W



9 008606 235773



900162 SABINAR

pendant light; steel, wood, black, brown
Hängeleuchte; Stahl, Holz, schwarz, braun
luminaire en suspension; acier, bois, noir, marron

H 1100, Ø 280



E27



1x 40W



9 008606 235780



900163 SABINAR

pendant light; steel, wood, black, brown
Hängeleuchte; Stahl, Holz, schwarz, braun
luminaire en suspension; acier, bois, noir, marron

H 1100, Ø 400



E27



1x 40W



9 008606 235797





96981



96982



96983

96981 SABINAR

pendant light; steel, white / wood, brown
Hängeleuchte; Stahl, weiss / Holz, braun
luminaire en suspension; acier, blanc / bois, marron

H 1100, Ø 180



E27 1x 60W



9 002759 969813



96982 SABINAR

pendant light; steel, white / wood, brown
Hängeleuchte; Stahl, weiss / Holz, braun
luminaire en suspension; acier, blanc / bois, marron

H 1100, Ø 280



E27 1x 60W



9 002759 969820

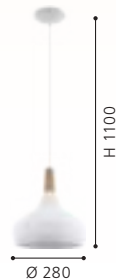

96983 SABINAR

pendant light; steel, white / wood, brown
Hängeleuchte; Stahl, weiss / Holz, braun
luminaire en suspension; acier, blanc / bois, marron

H 1100, Ø 400



E27 1x 60W



9 002759 969837

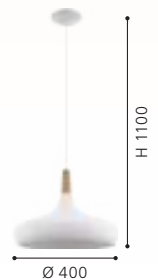



96985





96986



96985 SABINAR

pendant light; steel, brushed silver / wood, brown
Hängeleuchte; Stahl, silber gebürstet / Holz, braun
luminaire en suspension; acier, argent brossé / bois, marron

H 1100, Ø 280

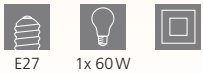

E27 1x 60W



9 002759 969851

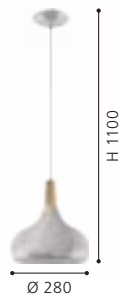

96986 SABINAR

pendant light; steel, brushed silver / wood, brown
Hängeleuchte; Stahl, silber gebürstet / Holz, braun
luminaire en suspension; acier, argent brossé / bois, marron

H 1100, Ø 400



E27 1x 60W



9 002759 969868





900186

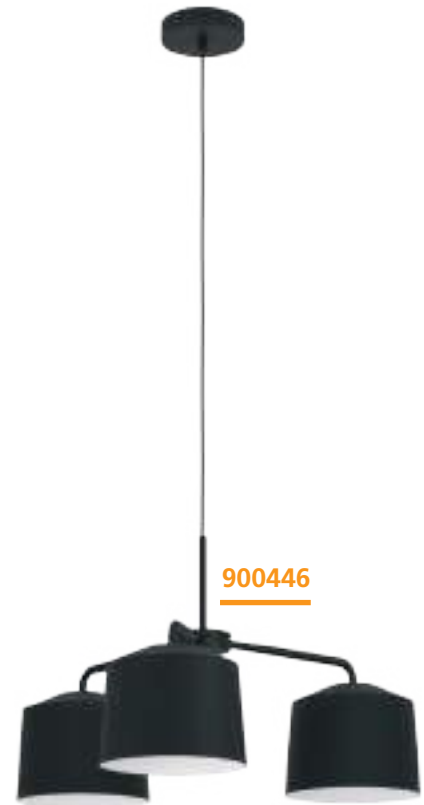

900446



900186 FILAGO

pendant light; steel, wood, black, brown / glass, black-grey-transparent
 Hängeleuchte; Stahl, Holz, schwarz, braun / Glas, schwarz-grau-transparent
 luminaire en suspension; acier, bois, noir, marron / verre, noir gris transparent

L 880, B 145, H 1100



E27



4x 40W



9 008606 235339



900446 CAGUANES

pendant light; steel, black, white
 Hängeleuchte; Stahl, schwarz, weiss
 luminaire en suspension; acier, noir, blanc

H 1100, Ø 665



E27



3x 40W



9 008606 243969

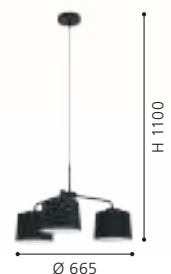



99702 VIGLIONI

pendant light; steel, wood, black, brown / glass vaporized, black-transparent

Hängeleuchte; Stahl, Holz, schwarz, braun / Glas bedampft, schwarz-transparent

luminaire en suspension; acier, bois, noir, marron / verre vaporisé, noir transparent

L 1060, B 165, H 1100



E27 3x 40W



9 002759 997021

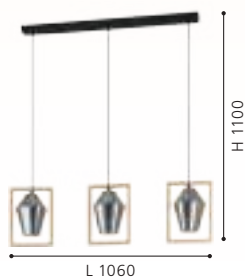

L 1060

99701 VIGLIONI

pendant light; steel, wood, black, brown / glass vaporized, black-transparent

Hängeleuchte; Stahl, Holz, schwarz, braun / Glas bedampft, schwarz-transparent

luminaire en suspension; acier, bois, noir, marron / verre vaporisé, noir transparent

L 230, B 165, H 1100



E27 1x 40W



9 002759 997014



L 230

900444 TARRAFO

pendant light; steel, wood, black, brown

Hängeleuchte; Stahl, Holz, schwarz, braun

luminaire en suspension; acier, bois, noir, marron

L 880, B 150, H 1100



E27 4x 40W



9 008606 243952

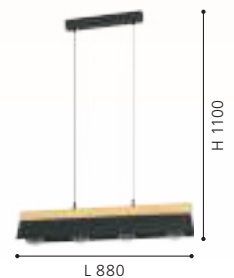

L 880



98591 CASTRALVO

pendant light; steel, wood, satin nickel, brown / fabric, white
 Hängeleuchte; Stahl, Holz, nickel-matt, braun / Textil, weiss
 luminaire en suspension; acier, bois, nickel mat, marron / tissu, blanc

L 1210, B 150, H 1100

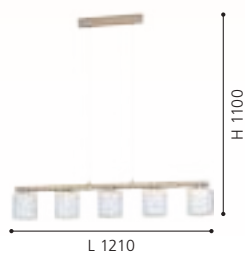

98592 CASTRALVO

pendant light; steel, wood, satin nickel, brown / glass vaporized, amber
 Hängeleuchte; Stahl, Holz, nickel-matt, braun / Glas bedampft, amber

luminaire en suspension; acier, bois, nickel mat, marron / verre vaporisé, ambre

L 1210, B 150, H 1100

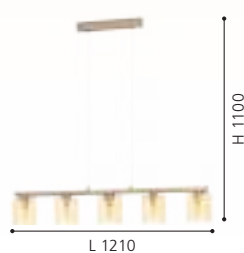

900313 CASTRALVO

pendant light; wood, steel, brown / fabric, black
 Hängeleuchte; Holz, Stahl, braun / Textil, schwarz
 luminaire en suspension; bois, acier, marron / tissu, noir

L 975, B 175, H 1100

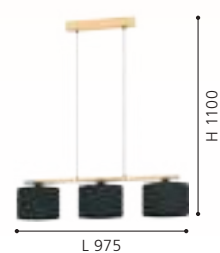

900313





CONTRISA

These luminaires are open at the top and have a beautiful play of light.

Diese Leuchten sind nach oben offen und haben ein schönes Lichtspiel.

Ces luminaires sont ouverts vers le haut et ont un beau jeu de lumière.

900381 CONTRISA

pendant light; steel, grey
Hängeleuchte; Stahl, grau
luminaire en suspension; acier, gris

H 1100, Ø 520



900379 CONTRISA

pendant light; steel, grey
Hängeleuchte; Stahl, grau
luminaire en suspension; acier, gris

H 1100, Ø 380



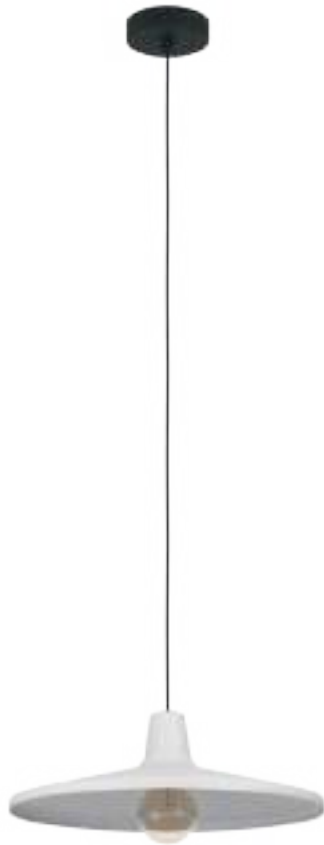

900833



MINIERE



900834

900362 MARIEL

pendant light; steel, wood, light grey, brown
 Hängeleuchte; Stahl, Holz, hellgrau, braun
 luminaire en suspension; acier, bois, gris clair, marron

L 910, B 190, H 1100

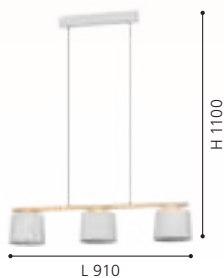

900833 MINIERE

pendant light; steel, black / steel, grey
 Hängeleuchte; Stahl, schwarz / Stahl, grau
 luminaire en suspension; acier, noir / acier, gris

H 1100, Ø 420

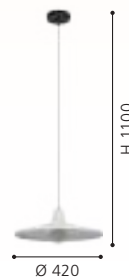

900834 MINIERE

pendant light; steel, black / steel, grey
 Hängeleuchte; Stahl, schwarz / Stahl, grau
 luminaire en suspension; acier, noir / acier, gris

L 995, B 420, H 1100





900696



900697

900696 GAETANO 1

pendant light; steel, black / steel, sandy, cream
 Hängeleuchte; Stahl, schwarz / Stahl, sandfarben, creme
 luminaire en suspension; acier, noir / acier, couleur sable, crème

H 1500, Ø 535



E27 1x 40W



9 008606 274222



900697 GAETANO 1

pendant light; steel, black / steel, grey, white
 Hängeleuchte; Stahl, schwarz / Stahl, grau, weiss
 luminaire en suspension; acier, noir / acier, gris, blanc

H 1500, Ø 535



E27 1x 40W



9 008606 274239





94936



94935

94936 GAETANO 1

pendant light; steel, black, gold
Hängeleuchte; Stahl, schwarz, gold
luminaire en suspension; acier, noir, or

H 1500, Ø 530



E27



1x 60W



9 002759 949365



94935 GAETANO 1

pendant light; steel, black, gold
Hängeleuchte; Stahl, schwarz, gold
luminaire en suspension; acier, noir, or

H 1500, Ø 380



E27



1x 60W



9 002759 949358

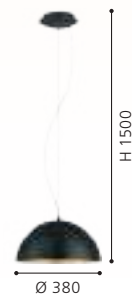



900849



900849 CENCIARA

pendant light; steel, black / steel, brushed brass, gold
 Hängeleuchte; Stahl, schwarz / Stahl, messing-gebürstet, gold
 luminaire en suspension; acier, noir / acier, laiton brossé, or

H 1100, Ø 400

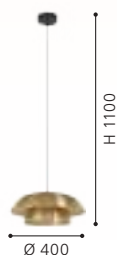

95755 NUVANO

pendant light; steel, brown, gold
 Hängeleuchte; Stahl, braun, gold
 luminaire en suspension; acier, marron, or

H 1100, Ø 480

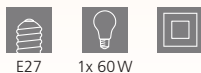

99663 NUVANO

pendant light; steel, black, gold
 Hängeleuchte; Stahl, schwarz, gold
 luminaire en suspension; acier, noir, or

L 985, B 225, H 1100





94938

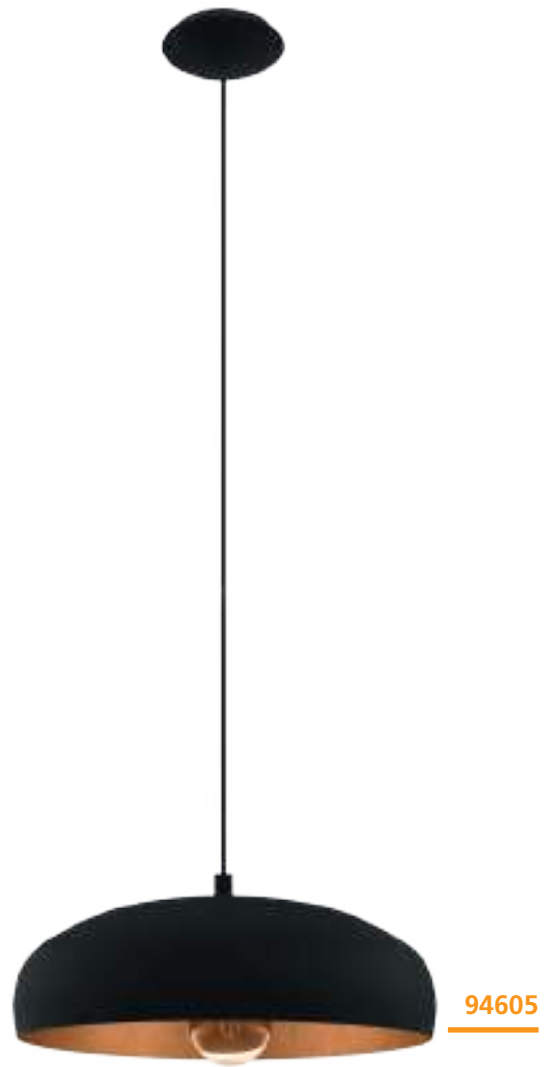

94605

94938 GAETANO 1

pendant light; steel, black, copper
 Hängeleuchte; Stahl, schwarz, kupfer
 luminaire en suspension; acier, noir, cuivre

H 1500, Ø 530



E27 1x 60W



9 002759 949389



94605 MOGANO 1

pendant light; steel, black, copper
 Hängeleuchte; Stahl, schwarz, kupfer
 luminaire en suspension; acier, noir, cuivre

H 1100, Ø 400

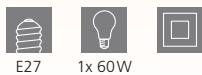

E27 1x 60W



9 002759 946050

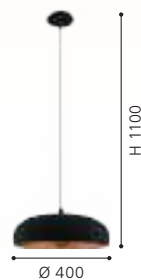

94606 MOGANO 1

pendant light; steel, white, copper
 Hängeleuchte; Stahl, weiss, kupfer
 luminaire en suspension; acier, blanc, cuivre

H 1100, Ø 400



E27 1x 60W



9 002759 946067





94606



98735

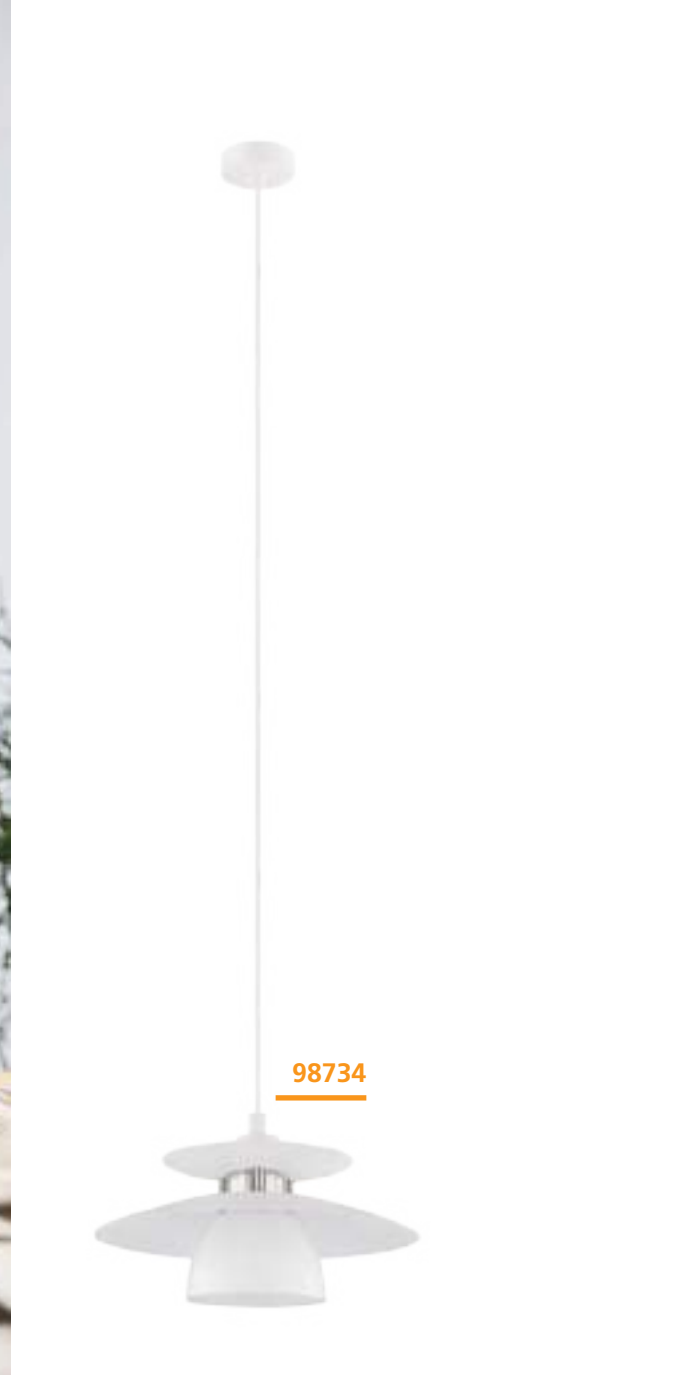

98734

98735 BRENDA

pendant light; steel, black, satin nickel
 Hängeleuchte; Stahl, schwarz, nickel-matt
 luminaire en suspension; acier, noir, nickel mat

H 1500, Ø 320



98734 BRENDA

pendant light; steel, white, satin nickel
 Hängeleuchte; Stahl, weiss, nickel-matt
 luminaire en suspension; acier, blanc, nickel mat

H 1500, Ø 320





87055



31666

87055 BRENDA

pendant light; plastic, steel, white, chrome / steel, white
 Hängeleuchte; Kunststoff, Stahl, weiss, chrom / Stahl, weiss
 luminaire en suspension; plastique, acier, blanc, chrome / acier, blanc

H 1300, Ø 430



E27 1x 60W



9 002759 870553

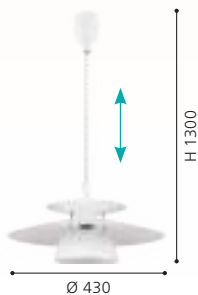

31666 BRENDA

pendant light; plastic, steel, black / steel, black, copper
 Hängeleuchte; Kunststoff, Stahl, schwarz / Stahl, schwarz, kupfer
 luminaire en suspension; plastique, acier, noir / acier, noir, cuivre

H 1100, Ø 430



E27 1x 60W



9 002759 316662



31666, 87055

This luminaires are flexible in height thanks to the spiral cables.

Diese Leuchten sind durch die Spiralkabel in der Höhe verstellbar.

La hauteur de ces lumières peut être ajustée à l'aide du câble en spirale.





87054

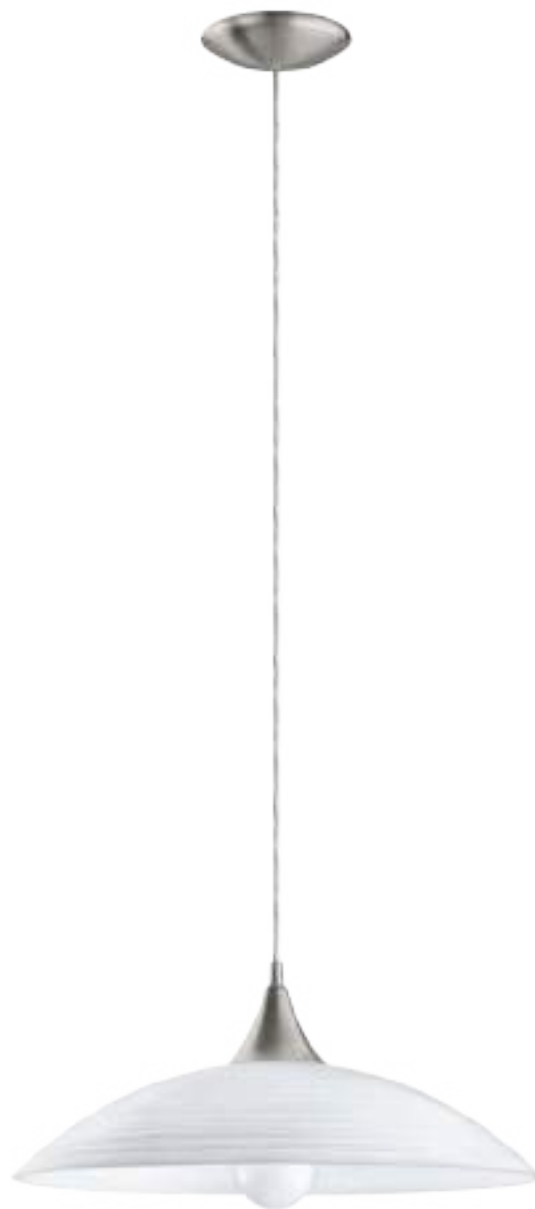

91496

87054 BRENDA

pendant light; steel, satin nickel / alabaster glass, white
 Hängeleuchte; Stahl, nickel-matt / Glas alabaster, weiss
 luminaire en suspension; acier, nickel mat / verre albâtre, blanc

H 1100, Ø 195



9 002759 870546



91496 LAZOLO

pendant light; steel, satin nickel / satin glass, white painted
 Hängeleuchte; Stahl, nickel-matt / Glas satiniert, weiss lackiert
 luminaire en suspension; acier, nickel mat / verre satiné, blanc laqué

H 1100, Ø 420



9 002759 914967



93468 MONTEFIO

pendant light; stainless steel, satin nickel / alabaster glass, white
 Hängeleuchte; Edelstahl, nickel-matt / Glas alabaster, weiss
 luminaire en suspension; acier inoxydable, nickel mat / verre albâtre, blanc

L 885, B 175, H 880 - 1300



9 002759 934682

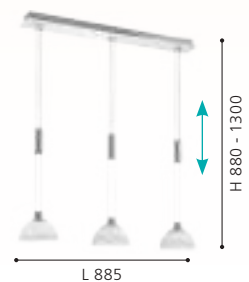



93468

LED



87008 LORD 2

pendant light; plastic, steel, grey, satin nickel / alabaster glass, white

Hängeleuchte; Kunststoff, Stahl, grau, nickel-matt / Glas alabaster, weiss

luminaire en suspension; plastique, acier, gris, nickel mat / verre albâtre, blanc

H 1100, Ø 360



E27

1x 60W

87009 LORD 2

pendant light; plastic, wood, silver, satin nickel, beech / alabaster glass, white

Hängeleuchte; Kunststoff, Holz, silber, nickel-matt, Buche / Glas alabaster, weiss

luminaire en suspension; plastique, bois, argent, nickel mat, hêtre / verre albâtre, blanc

H 1100, Ø 360



E27

1x 60W

3355, 87008, 87009



This luminaires are flexible in height thanks to the spiral cables.

Diese Leuchten sind durch die Spiralkabel in der Höhe verstellbar.

La hauteur de ces lumières peut être ajustée à l'aide du câble en spirale.



9 002759 870089

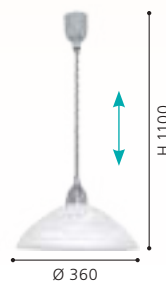

9 002759 870096

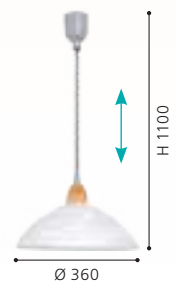



3355



90978



3355 ALESSANDRA

pendant light; plastic, white / alabaster glass, white
 Hängeleuchte; Kunststoff, weiss / Glas alabaster, weiss
 luminaire en suspension; plastique, blanc / verre albâtre, blanc

H 1100, Ø 380



E27 1x 60W

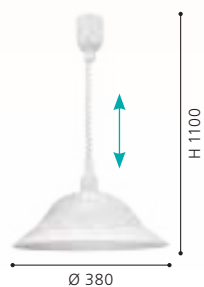

90978 ALBANY

pendant light; plastic, white / alabaster glass, white
 Hängeleuchte; Kunststoff, weiss / Glas alabaster, weiss
 luminaire en suspension; plastique, blanc / verre albâtre, blanc

H 1100, Ø 350



E27 1x 60W

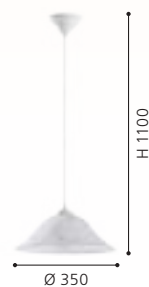

3355, 87008, 87009, 90978

These luminaires come with high quality processed alabaster glass.

Diese Leuchten sind mit hochwertigem Alabasterglas ausgestattet.

Ces luminaires viennent avec un abat-jour en verre d'albâtre haut de gamme.



3041

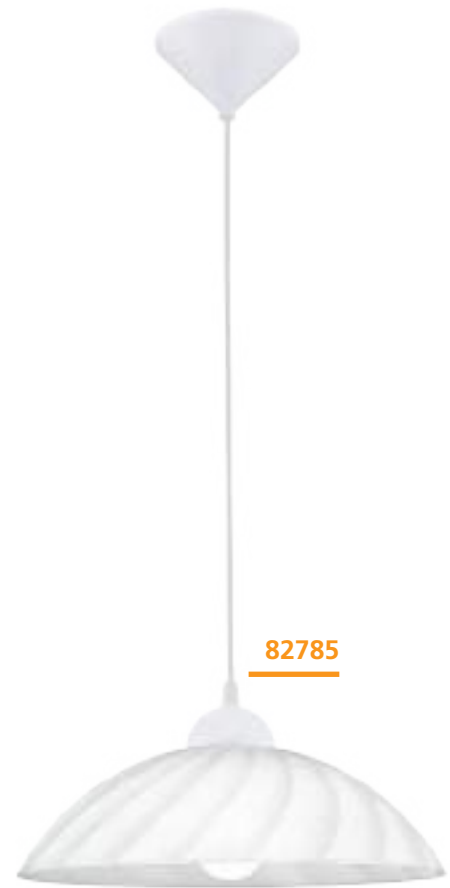

82785

3041 VETRO

pendant light; plastic, white / satin glass, white, purple, black
 Hängeleuchte; Kunststoff, weiss / Glas satiniert, weiss, lila, schwarz
 luminaire en suspension; plastique, blanc / verre satiné, blanc, violet, noir

H 1100, Ø 420



E27



1x 60W



9 002759 304102

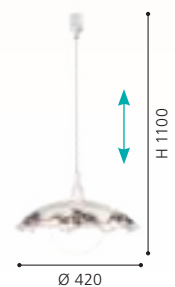



96474

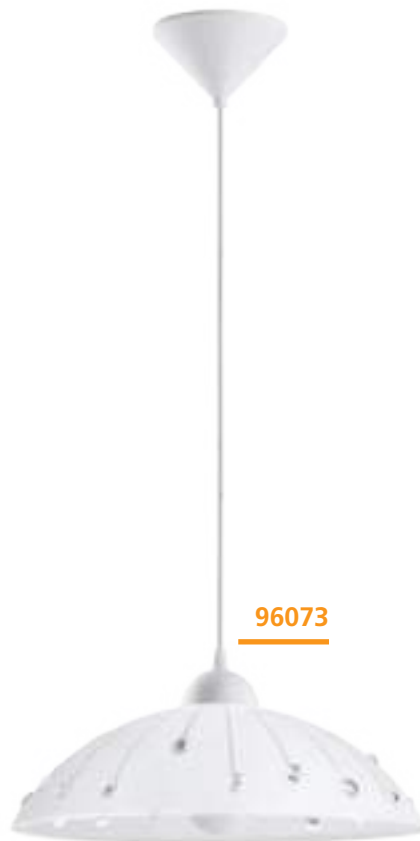

96073

3041, 96474

This luminaires are flexible in height thanks to the spiral cables.

Diese Leuchten sind durch die Spiralkabel in der Höhe verstellbar.

La hauteur de ces lumières peut être ajustée à l'aide du câble en spirale.



82785 VETRO

pendant light; plastic, white / satin glass, white
Hängeleuchte; Kunststoff, weiss / Glas satiniert, weiss
luminaire en suspension; plastique, blanc / verre satiné, blanc

H 1100, Ø 350



E27 1x 60W



9 002759 827854

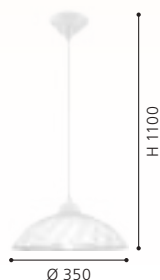

96474 ALVEZ

pendant light; plastic, white / structured glass, white, clear
Hängeleuchte; Kunststoff, weiss / Glas mit Struktur, weiss, klar
luminaire en suspension; plastique, blanc / verre avec structure, blanc, transparent

H 1100, Ø 420

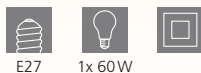

E27 1x 60W



9 002759 964740



96073 VETRO

pendant light; plastic, white / satin glass, brilliant glass, white, clear
Hängeleuchte; Kunststoff, weiss / Glas satiniert, Brillantglas, weiss, klar

luminaire en suspension; plastique, blanc / verre satiné, verre brillant, blanc, transparent

H 1100, Ø 350



E27 1x 60W



9 002759 960735



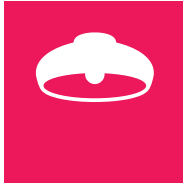

WALL & CEILING LUMINAIRES

WAND- & DECKENLEUCHTEN
APPLIQUES & PLAFONNIERS



EN OUR ALL-ROUNDERS

The range of wall and ceiling luminaires goes from simple to unusual designs. No matter if for the entrance area, hallway or your living rooms – these luminaires give the right light.

DE UNSERE ALLROUNDER

Das Sortiment an Wand- und Deckenleuchten reicht von schlichten bis hin zu ausgefallenen Designs. Egal ob für Eingangsbereich, Flur oder Ihre Wohnräume - diese Leuchten spenden das passende Licht.

FR NOS PASSE-PARTOUT























































La gamme d'éclairages muraux et de plafonds s'étend de designs simples à extraordinaires. Que ce soit pour l'entrée, le couloir ou vos espaces d'habitat - ces luminaires apportent la lumière appropriée.





OVERVIEW

WALL & CEILING LUMINAIRES
WAND- & DECKENLEUCHTEN
APPLIQUES & PLAFONNIERS

 AMANDOLO 480-481	 RUOTALE 482	 ULISANO 482	 PADULARI 482	 ROLIMARE 483	 ALTAFLOR 484-486	 MONIROTE 485, 487	 GAFARES 488-489
 ZAMPOTE 490	 IPOLITTO 490	 TIRRENARA 492	 MARINELLO 1 492	 MARINELLO 493	 MIRLAS 494	 TAMURIA 496	 BORDONARA 498
 MARMORATA 499	 BOCADELLA 1 500	 TREMEDAL 501	 MESSINARO 502	 BELSIANA 502-503	 BELSIANA 1 503	 ENCINITOS 505	 MOGANO 3 505
 MONTEBALDO 506	 BARRANCAS 506	 MORDAZO 507	 STAITI 507	 SILENTINA 508-509	 MACCHIONE 509	 PIEDRITAS 510	 MOGANO 512-513
 MOGANO 2 514	 CENCIARA 515	 MOHARRAS 515	 DUAIA 516	 VALCASOTTO 1 517	 TARRAFO 517	 BASURTU 518	 LORETO 518-519
 LORETO 1 519	 FORCAET 519	 MARIEL 520	 MAROJALES 520	 FILAGO 521	 CONDRADE 1 522	 CABO 522	 ACOLLA 523
 CLEMENTE 523	 FRADELO 1 524-525	 FRADELO 526-527	 VALLEMARE 529	 SORRENTA 1 529	 CANICOSA 2 530	 MONTENOVO 531	 POZONDON 531

 This product is available in different colors and shapes. / Dieser Artikel ist in unterschiedlichen Farben und Formen verfügbar. / Cet article est disponible en différentes couleurs et formes.

 GIRON 532	 GIRON-S 533	 FRANIA 534-535, 538-539	 FRANIA-S 536-537, 540-541	 SILERAS 541	 LANCIANO 1 542-543	 LANCIANO 542	 FERENTINO 544-545
 BATTISTONA 546	 BENARIBA 547	 COMPETA 1 548-549	 PALERMO 2 549	 CAPASSO 550	 RENDE 551	 NIEVES 1 552	 NIEVES 553
 PESCAITO 554	 MUSURITA 554-555	 LAURITO 556	 SELUCI 556-557	 VALCASOTTO 559	 LUPPINERIA 560-562	 PENJAMO 1 562	 PENJAMO 563
 CALAGRANO 564-565	 PALAGIANO 565	 PALAGIANO 1 566	 MENTALURGIA 567	 ELLA 568	 DURELO 569	 PLANET 570	 PLANET 1 570-573
 MARGITTA 1 575	 MARS 1 576-577	 MARS 577-578	 SALOME 578-579	 MAGITTA 1 580	 SCALEA 1 580	 GRAFIK 580	 NEMO 580
 MESTRE 582-583	 IMPERIAL 582	 ALMERA 583	 PASCAL 1 583	 CAMPANIA 584	 GERBERA 1 584	 COLTI 584	 SAN PERI 586
 STAITI 1 586	 TAZZOLI 589	 CIGLIE 589	 CARTIGNANO 590	 CIVITATE 591	 TIMPAROSSA 592	 ALAMILO 593	 GURARE 593



OVERVIEW

WALL & CEILING LUMINAIRES
WAND- & DECKENLEUCHTEN
APPLIQUES & PLAFONNIERS



ZINACUA
593



ZUBIALDE
594



TUDONS
595



ONO 2
595



MACCACARI
596



FELONICHE
597



SANIA 4
598-599



PASSA
600-603



GASCUERIA
604



ELIZONDO
604



FALICETTO
604



HAYES
605



TANURA
606



GUANAL
606



CADEGAL
608-609



REMIDOS
609



METRASS
610



METRASS 2
611



METRASS 1
613



SARGINTO
614-615



This product is available in different colors and shapes. / Dieser Artikel ist in unterschiedlichen Farben und Formen verfügbar. / Cet article est disponible en différentes couleurs et formes.

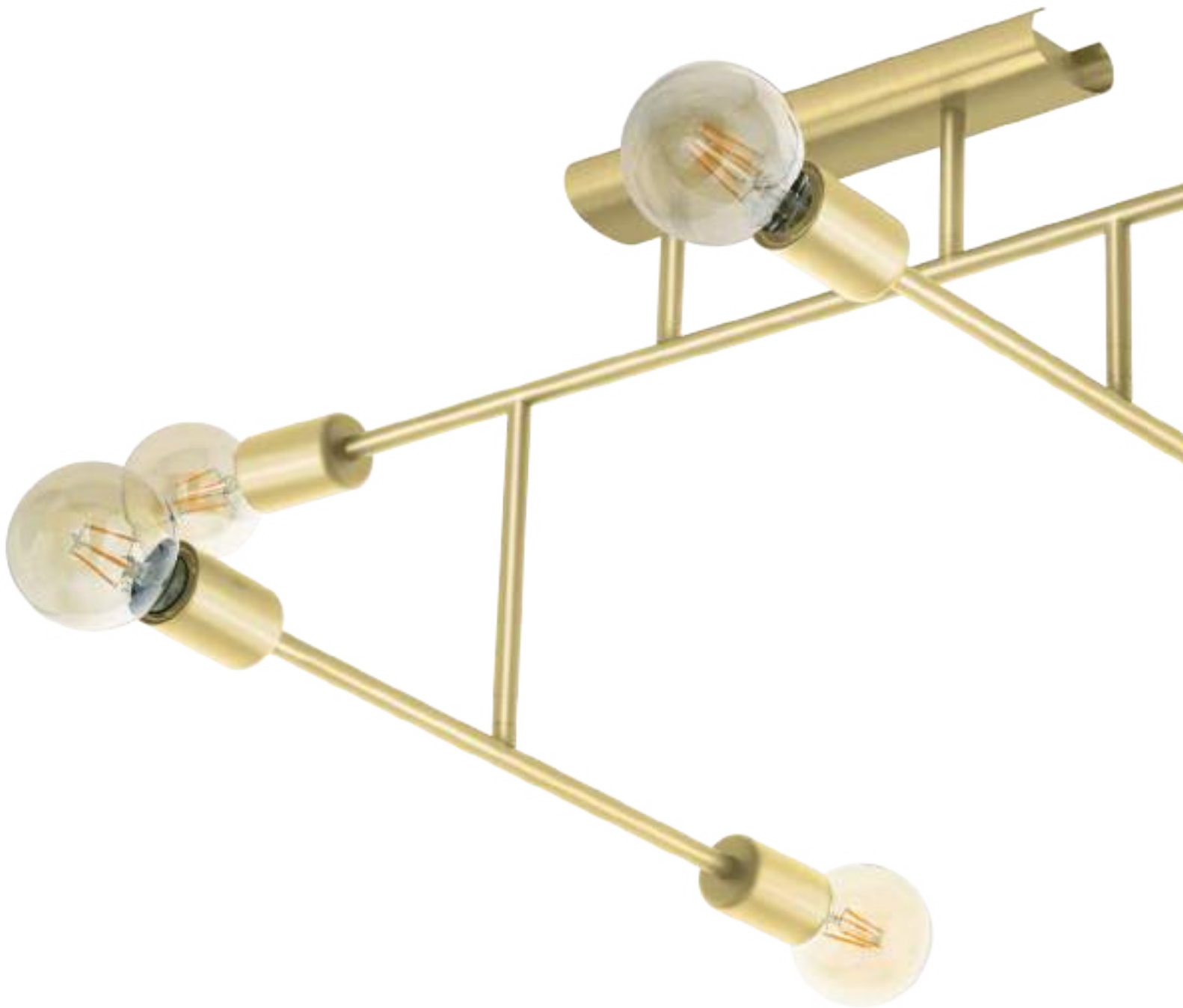

FUNCTIONAL OVERVIEW

FUNKTIONSÜBERSICHT

PRÉSENTATION FONCTIONNELLE

The listed boxes inform you about the respective functions of our wall and ceiling luminaires. You will find them on the catalogue pages next to the product illustrations. The coloured symbol area indicates the special characteristics of the respective luminaire/luminaire family, e.g. dimming function. In the grey area below you will find detailed information on this function, e.g. dimmable from 10% - 100%.

For luminaires that come with a remote control, you can control the respective functions with the remote control. For luminaires without remote control, the functions can be switched directly on the wall switch.

Die angeführten Boxen informieren Sie über die jeweiligen Funktionen unserer Wand- und Deckenleuchten. Sie finden sie auf den Katalogseiten jeweils neben den Produktabbildungen. Der farbige Symbolbereich weist darauf hin, welche besonderen Eigenschaften die jeweilige Leuchte/Leuchtenfamilie bietet, z.B. Dimmfunktion. Im grauen Bereich darunter finden Sie detaillierte Angaben zu dieser Funktion, z.B. dimmbar von 10% - 100%.

Ist eine Fernbedienung im Lieferumfang enthalten, können Sie die jeweiligen Funktionen mit der Fernbedienung steuern. Bei Leuchten ohne Fernbedienung können die Funktionen direkt am Wandschalter geschaltet werden.

Les boîtes de dialogue présentes vous informent sur les fonctions respectives de nos appliques et plafonniers. Vous les trouverez sur les pages du catalogue à côté des illustrations des produits. La zone colorée des symboles indique les caractéristiques particulières de chaque luminaire/famille de luminaires, par ex. la fonction de gradation. Dans la zone grise ci-dessous, vous trouverez des informations détaillées sur cette fonction, par ex. graduable de 10% - 100%.

Pour les luminaires équipés d'une télécommande, vous pouvez commander les fonctions correspondantes à l'aide de la télécommande. Pour les luminaires sans télécommande, les fonctions peuvent être commutées directement sur l'interrupteur mural.



DIMMABLE

e.g./z.B./par ex.
10 - 100%

The brightness of the luminaire can be steplessly controlled.

Die Helligkeit der Leuchte kann stufenlos im angegebenen Bereich gesteuert werden.

La luminosité du luminaire peut être réglée en continu.



STEP DIMMING

e.g./z.B./par ex.
10%/50%/100%

The brightness of the luminaire can be controlled step by step.

Die Helligkeit der Leuchte kann schrittweise gesteuert werden.

La luminosité du luminaire peut être réglée pas à pas.



TUNABLE WHITE

e.g./z.B./par ex.
2700 - 6500 K

The colour temperature can be controlled from warm to cold white LED light.

Die Farbtemperatur kann von warm- bis kaltweißem LED-Licht gesteuert werden.

La température de couleur peut être réglée de la lumière DEL blanche chaude à la lumière DEL blanche froide.



STEP TUNABLE

e.g./z.B./par ex.
3000/4000/5000 K

The colour temperature of warm to cold white LED light can be changed directly on the wall switch in 3 preset steps.

Die Farbtemperatur von warm- bis kaltweißem LED-Licht kann direkt am Wandschalter in 3 voreingestellten Schritten verändert werden.

La température de couleur peut être modifiée de la lumière DEL blanche chaude à la lumière DEL blanche froide directement sur l'interrupteur mural en 3 étapes prédéfinies.



NIGHT LIGHT FUNCTION

Luminaires can be switched to a night light mode. With included remote control or, for luminaires without remote control, via wall switch (ambient light).

Leuchten können auf einen Nacht-Licht-Modus umgeschaltet werden. Mit inkludierter Fernbedienung oder bei Leuchten ohne Fernbedienung per Wandschalter (Ambient light).

Les luminaires peuvent être commutés en mode veilleuse. Avec télécommande incluse ou, pour les luminaires sans télécommande, via interrupteur mural (lumière ambiante).



TIMER FUNCTION

e.g./z.B./par ex.
off after 30 sec.

The luminaire switches itself off after a preset time.

Die Leuchte schaltet sich nach einer voreingestellten Zeit selbst aus.

La lumière s'éteint d'elle-même après une durée prédéfinie.



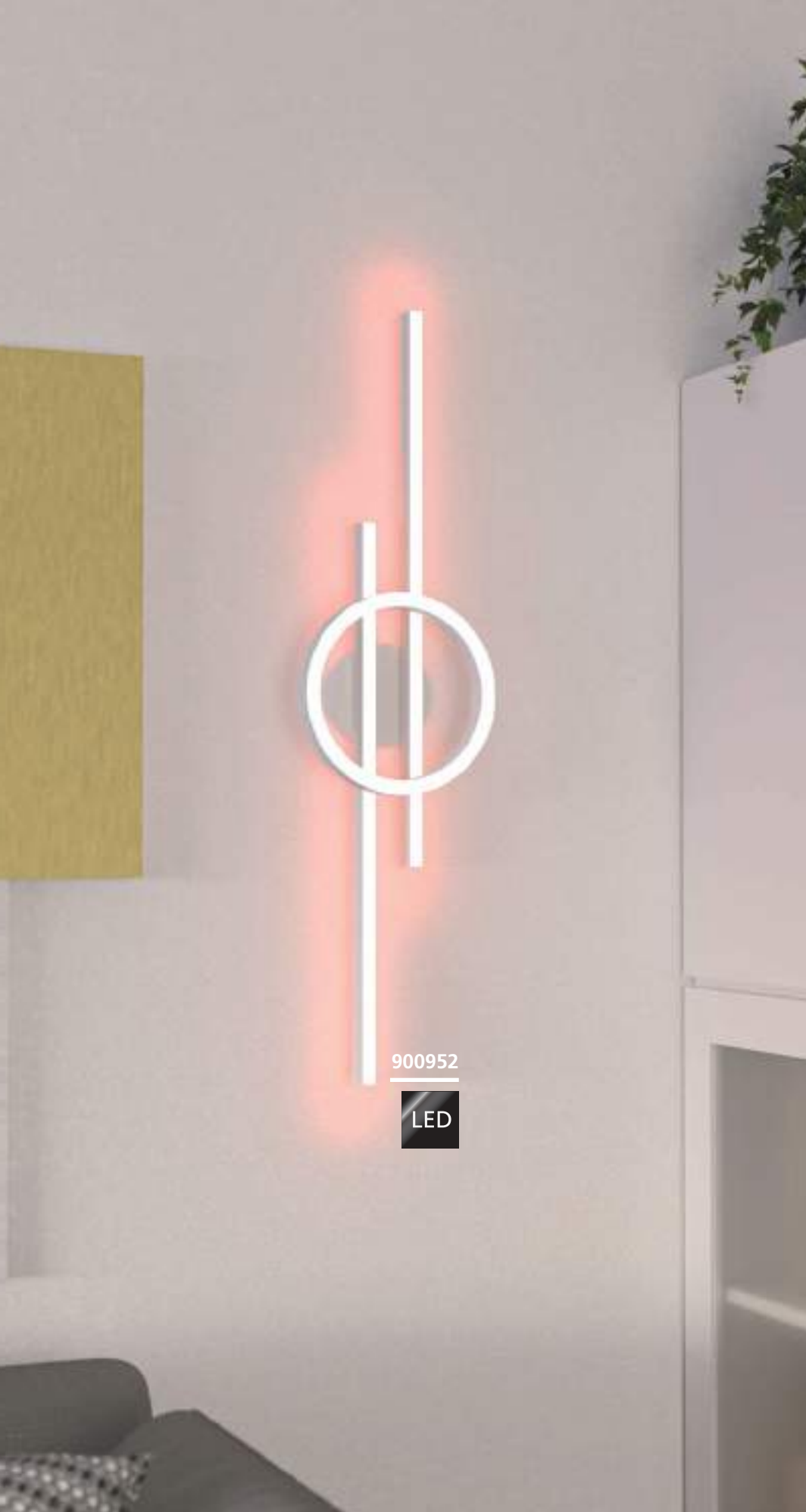

900952



REMOTE+

Our new 2.4 GHz REMOTE+ makes it easier than ever to control your lights. With its user-friendly design and simple control, you can easily adjust your luminaire to create the perfect ambiance for any occasion:

- › Stepless Dimming
- › Quick Pairing
- › Timer Function
- › Stepless Tunable White
- › Memory Effect
- › Control up to 10 REMOTE+ luminaires

Unsere neue 2,4-GHz REMOTE+ macht die Steuerung Ihrer Leuchten so einfach wie nie zuvor. Mit ihrem benutzerfreundlichen Design und der einfachen Steuerung können Sie Ihre Leuchte ganz einfach einstellen, um das perfekte Ambiente für jede Gelegenheit zu schaffen:

- › Stufenloses Dimmen
- › Schnelle Kopplung
- › Timer-Funktion
- › Stufenlos einstellbares Weiß
- › Memory-Effekt
- › Steuerung von bis zu 10 REMOTE+-Leuchten

Notre nouvelle REMOTE+ 2,4 GHz facilite plus que jamais le contrôle de vos lumières. Grâce à sa conception conviviale et à sa commande simple, vous pouvez facilement régler votre luminaire pour créer l'ambiance parfaite en toute occasion:

- › Gradation progressive
- › appairage rapide
- › Fonction de minuterie
- › Blanc réglable en continu
- › Effet de mémoire
- › Contrôle jusqu'à 10 luminaires REMOTE

900952 AMANDOLO

ceiling light; aluminium, steel, white / plastic, white
Deckenleuchte; Alu, Stahl, weiss / Kunststoff, weiss
plafonnier; aluminium, acier, blanc / plastique, blanc

L 775, B 200, H 75



23,5W



2850lm



CR2032



9 008606 275045

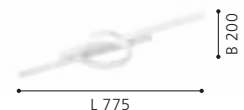



900953



900955



900954



900953 AMANDOLO

ceiling light; aluminium, steel, black / plastic, white
Deckenleuchte; Alu, Stahl, schwarz / Kunststoff, weiss
plafonnier; aluminium, acier, noir / plastique, blanc

L 775, B 200, H 75



23,5W 2850lm CR2032

900954 AMANDOLO

ceiling light; aluminium, steel, white / plastic, white
Deckenleuchte; Alu, Stahl, weiss / Kunststoff, weiss
plafonnier; aluminium, acier, blanc / plastique, blanc

L 675, B 380, H 65



19,5W 2400lm CR2032

900955 AMANDOLO

ceiling light; aluminium, steel, black / plastic, white
Deckenleuchte; Alu, Stahl, schwarz / Kunststoff, weiss
plafonnier; aluminium, acier, noir / plastique, blanc

L 675, B 380, H 65



19,5W 2400lm CR2032



9 008606 275052



9 008606 275069

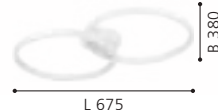

9 008606 275076





900471



900596



incl./inkl./inclus



900597



incl./inkl./inclus

900471 RUOTALE

ceiling light; aluminium, steel, black / plastic, white
Deckenleuchte; Alu, Stahl, schwarz / Kunststoff, weiss
plafonnier; aluminium, acier, noir / plastique, blanc

H 55, Ø 450



36W 4400lm

900596 ULISANO

ceiling light; aluminium, steel, black / plastic, white
Deckenleuchte; Alu, Stahl, schwarz / Kunststoff, weiss
plafonnier; aluminium, acier, noir / plastique, blanc

L 420, B 420, H 55



21W 3000lm

900597 PADULARI

ceiling light; aluminium, steel, black / plastic, white
Deckenleuchte; Alu, Stahl, schwarz / Kunststoff, weiss
plafonnier; aluminium, acier, noir / plastique, blanc

L 535, B 470, H 50



25,6W 3800lm Remote



9 008606 244096

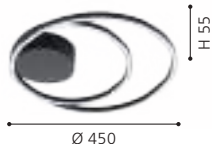

9 008606 244959



9 008606 244966





99395

LED



900419

LED



900419 ROLIMARE

ceiling light; aluminium, satin nickel / plastic, white
Deckenleuchte; Alu, nickel-matt / Kunststoff, weiss
plafonnier; aluminium, nickel mat / plastique, blanc

L 420, B 400, H 130



35W 5500lm

99395 ROLIMARE

ceiling light; aluminium, black / plastic, white
Deckenleuchte; Alu, schwarz / Kunststoff, weiss
plafonnier; aluminium, noir / plastique, blanc

L 420, B 400, H 130



35W 5500lm



9 008606 240999



9 002759 993955





99788

LED

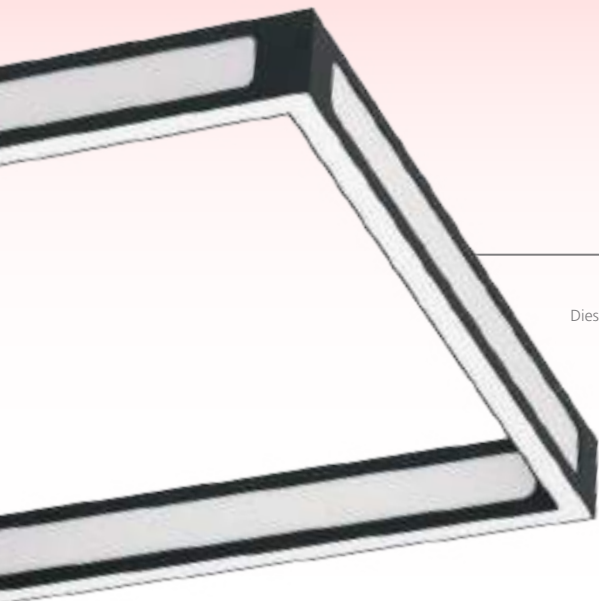

ALTAFLOR

These luminaires have an additional glow on the inside.
Diese Leuchten haben einen zusätzlichen Lichtschein nach Innen.
Ces luminaires ont une lueur supplémentaire à l'intérieur.

99788 ALTAFLOR

ceiling light; steel, black / plastic, white
Deckenleuchte; Stahl, schwarz / Kunststoff, weiss
plafonnier; acier, noir / plastique, blanc

L 650, B 300, H 70

LED

warm
WHITE



8x 2,8W 3040lm



9 002759 997885

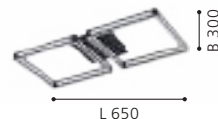



99787



99789



99792



incl./mkl./inclus

99787 ALTAFLOR

ceiling light; steel, black / plastic, white
 Deckenleuchte; Stahl, schwarz / Kunststoff, weiss
 plafonnier; acier, noir / plastique, blanc

L 315, B 315, H 70



4x 2,8W 1520lm

99789 ALTAFLOR

ceiling light; steel, black / plastic, white
 Deckenleuchte; Stahl, schwarz / Kunststoff, weiss
 plafonnier; acier, noir / plastique, blanc

L 1000, B 315, H 70



12x 2,8W 4560lm

99792 MONIROTE

ceiling light; steel, aluminium, black / plastic, white
 Deckenleuchte; Stahl, Alu, schwarz / Kunststoff, weiss
 plafonnier; acier, aluminium, noir / plastique, blanc

L 780, B 260, H 45



37W 4450lm Remote



9 002759 997878



9 002759 997892

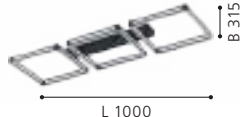

9 002759 997922

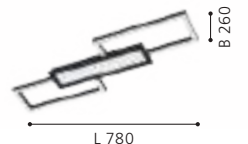



99784



99785



99786



99784 ALTAFLOR

ceiling light; steel, satin nickel / plastic, white
Deckenleuchte; Stahl, nickel-matt / Kunststoff, weiss
plafonnier; acier, nickel mat / plastique, blanc

L 315, B 315, H 70



4x 2,8W 1520lm

99785 ALTAFLOR

ceiling light; steel, satin nickel / plastic, white
Deckenleuchte; Stahl, nickel-matt / Kunststoff, weiss
plafonnier; acier, nickel mat / plastique, blanc

L 650, B 300, H 70



8x 2,8W 3040lm

99786 ALTAFLOR

ceiling light; steel, satin nickel / plastic, white
Deckenleuchte; Stahl, nickel-matt / Kunststoff, weiss
plafonnier; acier, nickel mat / plastique, blanc

L 1000, B 315, H 70



12x 2,8W 4560lm



9 002759 997847



9 002759 997854

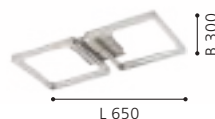

9 002759 997861

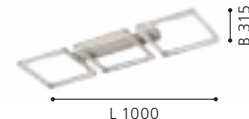



99791

LED

incl./inkl./inclus



99791 MONIROTE

ceiling light; steel, aluminium, satin nickel / plastic, white
 Deckenleuchte; Stahl, Alu, nickel-matt / Kunststoff, weiss
 plafonnier; acier, aluminium, nickel mat / plastique, blanc

L 780, B 260, H 45

LED

37W

tunable
 WHITE

4450lm



CONTROL
 UNIT

Remote



9 002759 997915



ALTAFLOR

These luminaires have an additional glow on the inside.

Diese Leuchten haben einen zusätzlichen Lichtschein nach Innen.

Ces luminaires ont une lueur supplémentaire à l'intérieur.



900421

LED

incl./inkl./inclus



DESIGN
HIGHLIGHT
DETAIL

900421 GAFARES

ceiling light; aluminium, steel, black, white / plastic, white
Deckenleuchte; Alu, Stahl, schwarz, weiss / Kunststoff, weiss
plafonnier; aluminium, acier, noir, blanc / plastique, blanc

L 405, B 290, H 55

LED

15W

tunable
WHITE

2100lm



CONTROL
UNIT

Remote





900422 GAFARES

ceiling light; aluminium, steel, black, white / plastic, white
 Deckenleuchte; Alu, Stahl, schwarz, weiss / Kunststoff, weiss
 plafonnier; aluminium, acier, noir, blanc / plastique, blanc

L 330, B 330, H 50



900423 GAFARES

ceiling light; aluminium, steel, gold, white / plastic, white
 Deckenleuchte; Alu, Stahl, gold, weiss / Kunststoff, weiss
 plafonnier; aluminium, acier, or, blanc / plastique, blanc

L 405, B 290, H 55



900424 GAFARES

ceiling light; aluminium, steel, gold, white / plastic, white
 Deckenleuchte; Alu, Stahl, gold, weiss / Kunststoff, weiss
 plafonnier; aluminium, acier, or, blanc / plastique, blanc

L 330, B 330, H 50

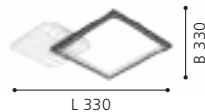



900329

LED



900328

LED

900329 ZAMPOTE

ceiling light; aluminium, steel, white, black / plastic, white
Deckenleuchte; Alu, Stahl, weiss, schwarz / Kunststoff, weiss
plafonnier; aluminium, acier, blanc, noir / plastique, blanc

L 380, B 380, H 50

LED

warm
WHITE
3300lm

STEP
DIMMING



900328 ZAMPOTE

ceiling light; aluminium, steel, white, black / plastic, white
Deckenleuchte; Alu, Stahl, weiss, schwarz / Kunststoff, weiss
plafonnier; aluminium, acier, blanc, noir / plastique, blanc

H 50, Ø 420

LED

warm
WHITE
3400lm

STEP
DIMMING



99817 IPOLITTO

ceiling light; aluminium, steel, black / plastic, white
Deckenleuchte; Alu, Stahl, schwarz / Kunststoff, weiss
plafonnier; aluminium, acier, noir / plastique, blanc

L 995, B 165, H 245

LED

warm
WHITE
4x 7,5W 3600lm



9 008606 238101

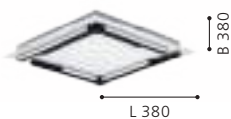

9 008606 238095



9 002759 998172

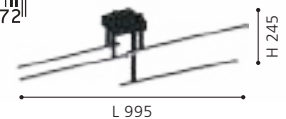



99817

LED



900603



incl./inkl./inclus



900604



incl./inkl./inclus



99793



900603 TIRRENARA

ceiling light; steel, wood, black, brown / plastic, white
Deckenleuchte; Stahl, Holz, schwarz, braun / Kunststoff, weiss
plafonnier; acier, bois, noir, marron / plastique, blanc

L 370, B 370, H 55



4x 5,4W 2600lm

Remote

900604 TIRRENARA

ceiling light; steel, wood, black, brown / plastic, white
Deckenleuchte; Stahl, Holz, schwarz, braun / Kunststoff, weiss
plafonnier; acier, bois, noir, marron / plastique, blanc

L 780, B 305, H 55



2x 9,2W 3960lm 1x 13,7W

Remote

99793 MARINELLO 1

ceiling light; aluminium, steel, wood, black, brown / plastic, white
Deckenleuchte; Alu, Stahl, Holz, schwarz, braun / Kunststoff, weiss
plafonnier; aluminium, acier, bois, noir, marron / plastique, blanc

L 500, B 500, H 90



4x 5,3W 2800lm



9 008606 245017

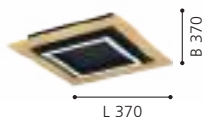

9 008606 245024

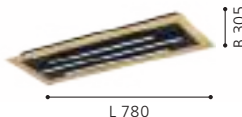

9 002759 997939

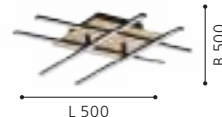



99659

LED

incl./inkl./inclus



99659 MARINELLO

ceiling light; aluminium, steel, wood, black, brown / plastic, white

Deckenleuchte; Alu, Stahl, Holz, schwarz, braun / Kunststoff, weiss

plafonnier; aluminium, acier, bois, noir, marron / plastique, blanc

L 485, B 485, H 55

LED

2x 17W

tunable
WHITE

4400lm

LED

4,2W

tunable
WHITE

590lm



CONTROL
UNIT

Remote



9 002759 996598





98861 MIRLAS

ceiling light; wood, steel, brown / plastic, white
 Deckenleuchte; Holz, Stahl, braun / Kunststoff, weiss
 plafonnier; bois, acier, marron / plastique, blanc

L 360, B 210, H 90



E27



2x 9W

98862 MIRLAS

ceiling light; wood, steel, brown / plastic, white
 Deckenleuchte; Holz, Stahl, braun / Kunststoff, weiss
 plafonnier; bois, acier, marron / plastique, blanc

L 690, B 270, H 90



E27



4x 9W

98863 MIRLAS

ceiling light; wood, steel, brown / plastic, white
 Deckenleuchte; Holz, Stahl, braun / Kunststoff, weiss
 plafonnier; bois, acier, marron / plastique, blanc

L 540, B 520, H 90



E27



6x 9W



9 002759 988616

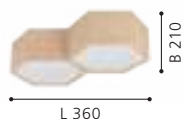

9 002759 988623

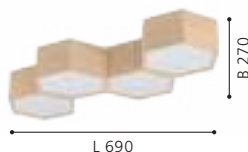

9 002759 988630

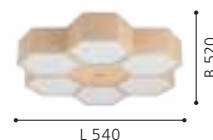



98863



99656

LED



TAMURIA

This luminaires have rotatable panels in wood look and black.
Diese Artikel verfügen über Platten in Holzoptik und schwarz zum Wechseln.
Ces luminaires a des panneaux en bois optique et noir à changer.

99656 TAMURIA

ceiling light; steel, wood, black, brown / plastic, white
Deckenleuchte; Stahl, Holz, schwarz, braun / Kunststoff, weiss
plafonnier; acier, bois, noir, marron / plastique, blanc

L 435, B 435, H 70



21W 2700lm

99655 TAMURIA

ceiling light; steel, wood, black, brown / plastic, white
Deckenleuchte; Stahl, Holz, schwarz, braun / Kunststoff, weiss
plafonnier; acier, bois, noir, marron / plastique, blanc

L 285, B 285, H 60



10,8W 1300lm



9 002759 996567



9 002759 996550





99655





900573



900571



900572



900573 BORDONARA

ceiling light; aluminium, steel, black, white / plastic, white
Deckenleuchte; Alu, Stahl, schwarz, weiss / Kunststoff, weiss
plafonnier; aluminium, acier, noir, blanc / plastique, blanc

L 1195, B 295



35W



5400lm



Remote



900571 BORDONARA

ceiling light; aluminium, steel, black, white / plastic, white
Deckenleuchte; Alu, Stahl, schwarz, weiss / Kunststoff, weiss
plafonnier; aluminium, acier, noir, blanc / plastique, blanc

L 450, B 450



21,5W



2800lm



Remote



900572 BORDONARA

ceiling light; aluminium, steel, black, white / plastic, white
Deckenleuchte; Alu, Stahl, schwarz, weiss / Kunststoff, weiss
plafonnier; aluminium, acier, noir, blanc / plastique, blanc

L 595, B 595



36W



4900lm



Remote



9 008606 244744

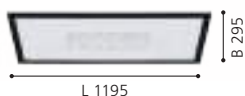

9 008606 244720



9 008606 244737





900559

LED



900561

LED



900558

LED



900559 MARMORATA

ceiling light; aluminium, steel, black, white / plastic, white
Deckenleuchte; Alu, Stahl, schwarz, weiss / Kunststoff, weiss
plafonnier; aluminium, acier, noir, blanc / plastique, blanc

L 445, B 445



9 008606 244621



900561 MARMORATA

ceiling light; aluminium, steel, black, white / plastic, white
Deckenleuchte; Alu, Stahl, schwarz, weiss / Kunststoff, weiss
plafonnier; aluminium, acier, noir, blanc / plastique, blanc

L 595, B 295



9 008606 244638

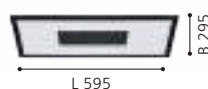

900558 MARMORATA

ceiling light; aluminium, steel, black, white / plastic, white
Deckenleuchte; Alu, Stahl, schwarz, weiss / Kunststoff, weiss
plafonnier; aluminium, acier, noir, blanc / plastique, blanc

H 70, Ø 450



9 008606 244614





98319



98317



98318

98319 BOCADELLA 1

ceiling light; steel, black
Deckenleuchte; Stahl, schwarz
plafonnier; acier, noir

H 360, Ø 920



E27

12x 60W



9 002759 983192

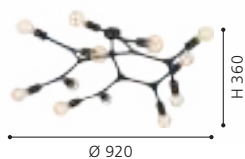

Ø 920

H 360

98317 BOCADELLA 1

ceiling light; steel, black
Deckenleuchte; Stahl, schwarz
plafonnier; acier, noir

H 215, Ø 345



E27

3x 60W



9 002759 983178

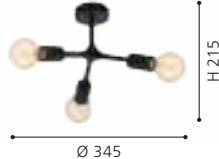

Ø 345

H 215

98318 BOCADELLA 1

ceiling light; steel, black
Deckenleuchte; Stahl, schwarz
plafonnier; acier, noir

H 365, Ø 640



E27

9x 60W



9 002759 983185

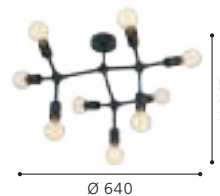

Ø 640

H 365



98507

98507 TREMEDAL

ceiling light; steel, black
Deckenleuchte; Stahl, schwarz
plafonnier; acier, noir

H 215, Ø 560



E27



1x 28W

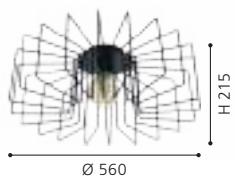



900367



98034

900367 MESSINARO

ceiling light; steel, black, brushed brass
 Deckenleuchte; Stahl, schwarz, messing-gebürstet
 plafonnier; acier, noir, laiton brossé

L 720, B 280, H 115



E27



3x 40W

98034 BELSIANA

ceiling light; steel, black
 Deckenleuchte; Stahl, schwarz
 plafonnier; acier, noir

L 890, B 510, H 350



E27



6x 40W



9 008606 243525



9 002759 980344

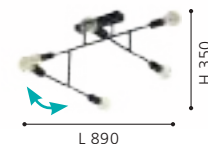



98035

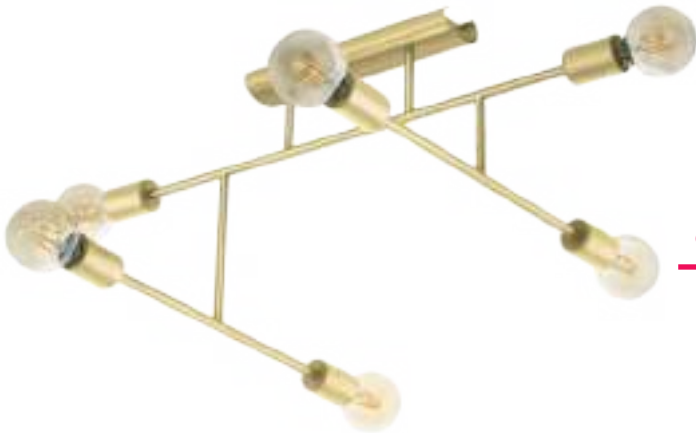

98881

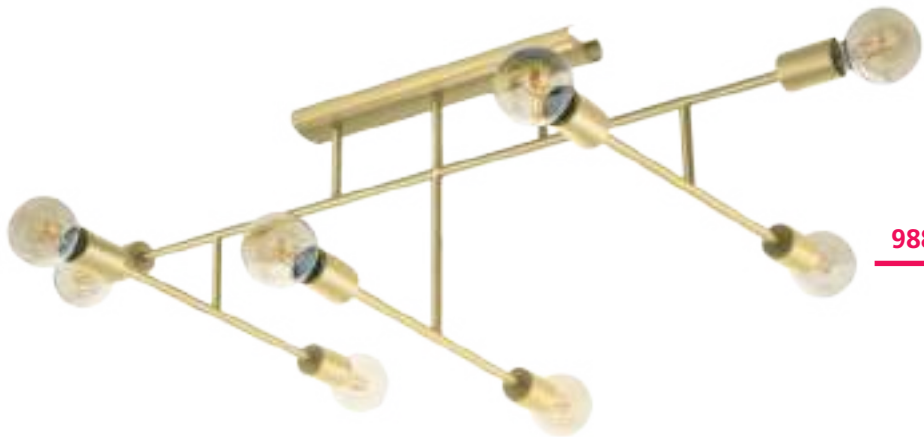

98882

98035 BELSIANA

ceiling light; steel, black
Deckenleuchte; Stahl, schwarz
plafonnier; acier, noir

L 1180, B 510, H 350



E27 8x 40W

98881 BELSIANA 1

ceiling light; steel, brushed brass
Deckenleuchte; Stahl, messing-gebürstet
plafonnier; acier, laiton brossé

L 1155, B 510, H 455



E27 6x 40W

98882 BELSIANA 1

ceiling light; steel, brushed brass
Deckenleuchte; Stahl, messing-gebürstet
plafonnier; acier, laiton brossé

L 1180, B 510, H 350



E27 8x 40W



9 002759 980351

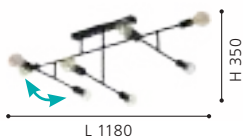

9 002759 988814

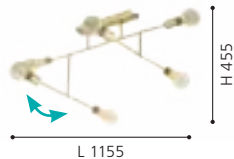

9 002759 988821

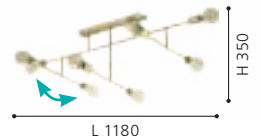



99664





900721



MOGANO 3



900792

99664 ENCINITOS

ceiling light; steel, black, gold
Deckenleuchte; Stahl, schwarz, gold
plafonnier; acier, noir, or

H 260, Ø 450



E27 1x 40W



9 002759 996642

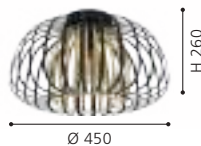

900721 MOGANO 3

ceiling light; steel, black
Deckenleuchte; Stahl, schwarz
plafonnier; acier, noir

H 180, Ø 430



E27 1x 40W



9 008606 254309

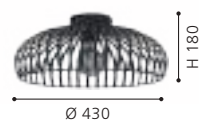

900792 MOGANO 3

ceiling light; steel, black
Deckenleuchte; Stahl, schwarz
plafonnier; acier, noir

H 180, Ø 280



E27 1x 40W



9 008606 254217



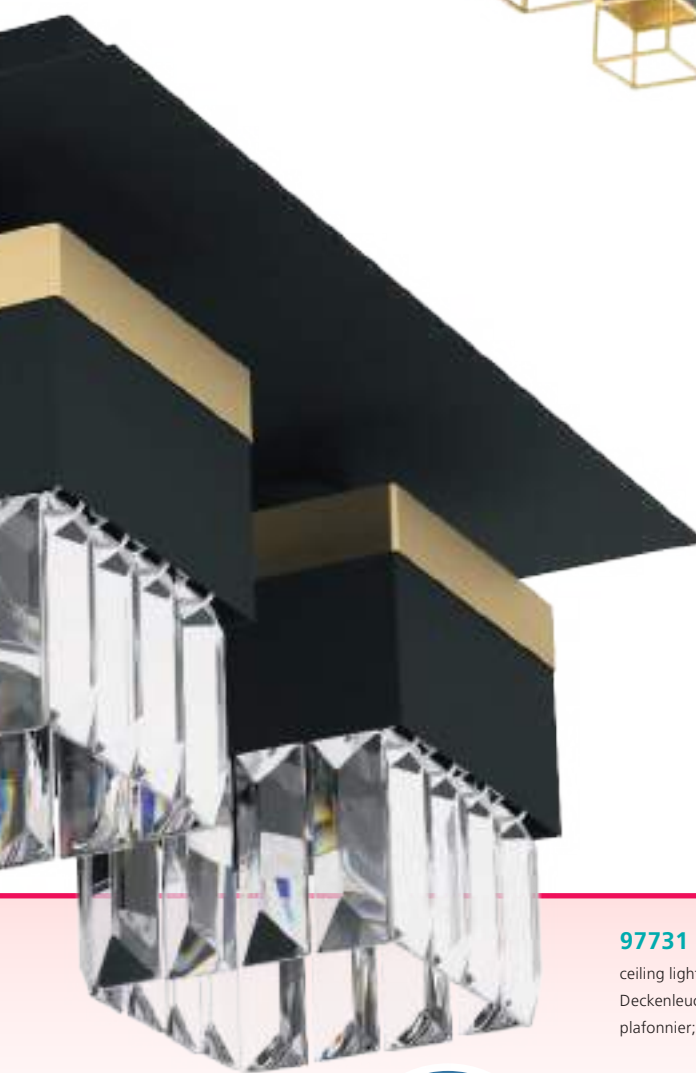

97731

LED



900302

DESIGN
HIGHLIGHT
DETAIL

97731 MONTEBALDO

ceiling light; steel, black, gold
Deckenleuchte; Stahl, schwarz, gold
plafonnier; acier, noir, or

L 380, B 380, H 170



GU10



4x 4,5W



warm
WHITE

4x

345lm

900302 BARRANCAS

ceiling light; steel, black, gold / brilliant glass, clear
Deckenleuchte; Stahl, schwarz, gold / Brillantglas, klar
plafonnier; acier, noir, or / verre brillant, transparent

L 380, B 380, H 180



E14



4x 40W



9 002759 977313

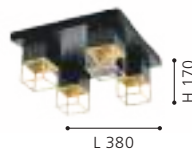

9 008606 242764

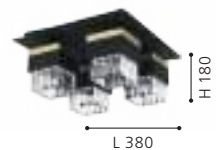



900524



97904



97895

900524 MORDAZO

ceiling light; steel, black / fabric, wood, anthracite-brown, white
 Deckenleuchte; Stahl, schwarz / Textil, Holz, anthrazit-braun, weiss
 plafonnier; acier, noir / tissu, bois, marron anthracite, blanc

L 510, B 510, H 175



E27 4x 28W

97904 STAITI

ceiling light; steel, black
 Deckenleuchte; Stahl, schwarz
 plafonnier; acier, noir

H 140, Ø 760



E27 7x 60W

97895 STAITI

ceiling light; steel, black / fabric, black, gold
 Deckenleuchte; Stahl, schwarz / Textil, schwarz, gold
 plafonnier; acier, noir / tissu, noir, or

H 235, Ø 840



E27 7x 40W



9 008606 244522

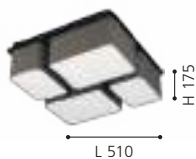

9 002759 979041

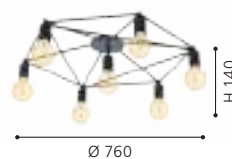

9 002759 978952

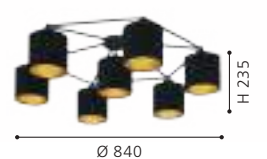



98333



98331



98332

98333 SILENTINA

ceiling light; steel, black
Deckenleuchte; Stahl, schwarz
plafonnier; acier, noir

L 540, B 180, H 205



E27



3x 40W



9 002759 983338

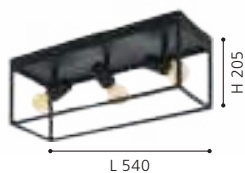

98331 SILENTINA

ceiling light; steel, black
Deckenleuchte; Stahl, schwarz
plafonnier; acier, noir

L 180, B 180, H 205



E27



1x 40W



9 002759 983314

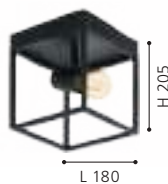

98332 SILENTINA

ceiling light; steel, black
Deckenleuchte; Stahl, schwarz
plafonnier; acier, noir

L 360, B 180, H 205



E27



2x 40W



9 002759 983321





98334



900509

98334 SILENTINA

ceiling light; steel, black
Deckenleuchte; Stahl, schwarz
plafonnier; acier, noir

L 360, B 360, H 205



E27



4x 40W



9 002759 983345

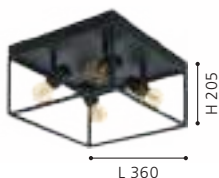

900509 MACCHIONE

wall light; steel, black, brass
Wandleuchte; Stahl, schwarz, messing
Applique; acier, noir, laiton

L 500, H 110, A 85



E27



4x 10W



9 008606 244393

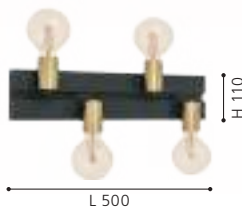

900509

Sockets are individually alignable for the customer with the help of a magnet. The luminaires work both as a wall luminaire, and as a ceiling luminaire.

Fassungen sind mithilfe eines Magnets für den Kunden individuell ausrichtbar. Die Leuchten funktionieren sowohl als Wandleuchte, als auch als Deckenleuchte.

Les douilles peuvent être orientées individuellement par le client à l'aide d'un aimant. Les luminaires fonctionnent aussi bien comme appliques murales que comme plafonniers.



900357



900356

900357 PIEDRITAS

ceiling light; steel, black
Deckenleuchte; Stahl, schwarz
plafonnier; acier, noir

L 730, B 180, H 205



E27

3x 40W



9 008606 235728



L 730

900356 PIEDRITAS

ceiling light; steel, black
Deckenleuchte; Stahl, schwarz
plafonnier; acier, noir

L 515, B 180, H 205



E27

2x 40W



9 008606 235711

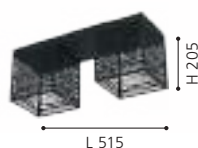

L 515

900355 PIEDRITAS

ceiling light; steel, black
Deckenleuchte; Stahl, schwarz
plafonnier; acier, noir

L 180, B 180, H 205



E27

1x 40W



9 008606 235704



L 180



900355





94547



94548



900359

94547 MOGANO

ceiling light; steel, black, copper
Deckenleuchte; Stahl, schwarz, kupfer
plafonnier; acier, noir, cuivre

H 170, Ø 400



E27 1x 60W



9 002759 945473



94548 MOGANO

ceiling light; steel, white, silver
Deckenleuchte; Stahl, weiss, silber
plafonnier; acier, blanc, argent

H 170, Ø 400



E27 1x 60W



9 002759 945480



900359 MOGANO

ceiling light; steel, mocha-coloured
Deckenleuchte; Stahl, Mokkafarben
plafonnier; acier, café

H 175, Ø 400

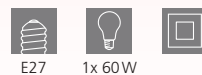

E27 1x 60W



9 008606 235315





43637



43637 MOGANO

ceiling light; steel, black
Deckenleuchte; Stahl, schwarz
plafonnier; acier, noir

H 170, Ø 400



E27



1x 60W





900553



900554



900555

900553 MOGANO 2

ceiling light; steel, black
Deckenleuchte; Stahl, schwarz
plafonnier; acier, noir

H 175, Ø 280



E27 1x 40W

900554 MOGANO 2

ceiling light; steel, black, gold
Deckenleuchte; Stahl, schwarz, gold
plafonnier; acier, noir, or

H 175, Ø 280



E27 1x 40W

900555 MOGANO 2

ceiling light; steel, black, copper
Deckenleuchte; Stahl, schwarz, kupfer
plafonnier; acier, noir, cuivre

H 175, Ø 280



E27 1x 40W





900848



900736



900848 CENCIARA

ceiling light; steel, black / steel, brushed brass, gold
 Deckenleuchte; Stahl, schwarz / Stahl, messing-gebürstet, gold
 plafonnier; acier, noir / acier, laiton brossé, or

H 180, Ø 400



E27 1x 40W



900736 MOHARRAS

ceiling light; wood, brown / steel, sandy
 Deckenleuchte; Holz, braun / Stahl, sandfarben
 plafonnier; bois, marron / acier, couleur sable

H 160, Ø 400



E27 1x 40W



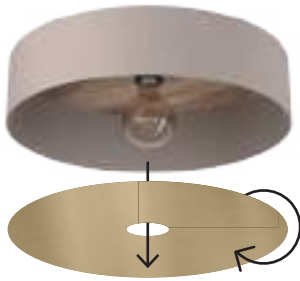

DUAIA

The look of these luminaires can be changed very easily thanks to the reversible plate. Front: wood look / back: brushed brass

Die Optik dieser Leuchten lässt sich durch die umkehrbare Platte ganz einfach verändern. Vorderseite: holzoptik / Rückseite: messing gebürstet

L'aspect de ces luminaires peut être facilement modifié grâce à la plaque réversible. face avant : aspect bois / face arrière : laiton brossé



900837



900838



900837 DUAIA

ceiling light; steel, umbra grey / wood, steel, brown, brushed brass

Deckenleuchte; Stahl, Umbragrau / Holz, Stahl, braun, messing-gebürstet

plafonnier; acier, Gris ombre / bois, acier, marron, laiton brossé

H 160, Ø 420



900838 DUAIA

ceiling light; steel, taupe structure / wood, steel, brown, brushed brass

Deckenleuchte; Stahl, taupe-struktur / Holz, Stahl, braun, messing-gebürstet

plafonnier; acier, taupe structuré / bois, acier, marron, laiton brossé

H 160, Ø 420





900435

LED



900443



900435 VALCASOTTO 1

ceiling light; steel, wood, black, brown
 Deckenleuchte; Stahl, Holz, schwarz, braun
 plafonnier; acier, bois, noir, marron

L 370, B 370, H 100



GU10



4x 4,5W



warm
WHITE

4x
345lm

900443 TARRAFO

ceiling light; steel, wood, black, brown
 Deckenleuchte; Stahl, Holz, schwarz, braun
 plafonnier; acier, bois, noir, marron

L 640, B 150, H 155



E27



3x 40W



9 008606 240586

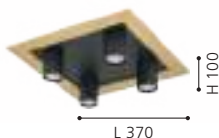

9 008606 243945





99667



900188

DESIGN
HIGHLIGHT
DETAIL



99667 BASURTU

ceiling light; steel, black
Deckenleuchte; Stahl, schwarz
plafonnier; acier, noir

H 270, Ø 1050

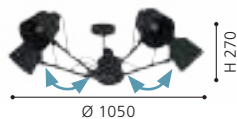

900188 LORETO

ceiling light; steel, black, white
Deckenleuchte; Stahl, schwarz, weiss
plafonnier; acier, noir, blanc

H 355, Ø 1145

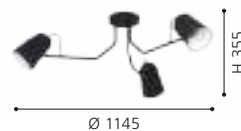



900157



900614



900865

900157 LORETO

wall light; steel, black, white
Wandleuchte; Stahl, schwarz, weiss
Applique; acier, noir, blanc

L 670, B 140, H 365



E27 1x 40W



9 008606 235766



L 670

H 365

900614 LORETO 1

wall light; steel, black, white
Wandleuchte; Stahl, schwarz, weiss
Applique; acier, noir, blanc

L 140, H 350, A 1030

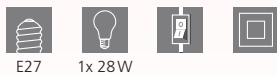

E27 1x 28W



9 008606 245116

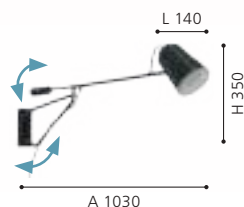

A 1030

H 350

900865 FORCADET

wall light; steel, black, grey
Wandleuchte; Stahl, schwarz, grau
Applique; acier, noir, gris

L 180, H 405, A 905



E27 1x 40W



9 008606 273942

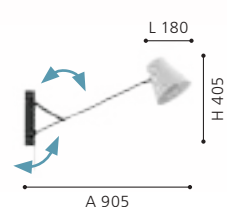

A 905

H 405



900361



98514



98514

900361 MARIEL

ceiling light; steel, wood, light grey, brown
 Deckenleuchte; Stahl, Holz, hellgrau, braun
 plafonnier; acier, bois, gris clair, marron

L 910, B 190, H 255



E27



3x 40W

98514 MAROJALES

ceiling light; steel, black / glass vaporized, black-transparent
 Deckenleuchte; Stahl, schwarz / Glas bedampft, schwarz-trans-
 parent
 plafonnier; acier, noir / verre vaporisé, noir transparent

L 555, B 180, H 280



E27



2x 28W



9 008606 239108



9 002759 985141





900825



900826



900185



900825 FILAGO

ceiling light; wood, steel, brown / glass, black-grey-transparent
Deckenleuchte; Holz, Stahl, braun / Glas, schwarz-grau-transparent
plafonnier; bois, acier, marron / verre, noir gris transparent

H 200, Ø 145



E27 1x 40W

900826 FILAGO

wall light; wood, steel, brown, black / glass, black-grey-transparent
Wandleuchte; Holz, Stahl, braun, schwarz / Glas, schwarz-grau-transparent
Applique; bois, acier, marron, noir / verre, noir gris transparent

L 145, H 200, A 200



E27 1x 40W

900185 FILAGO

ceiling light; steel, wood, black, brown / glass, black-grey-transparent
Deckenleuchte; Stahl, Holz, schwarz, braun / Glas, schwarz-grau-transparent
plafonnier; acier, bois, noir, marron / verre, noir gris transparent

L 880, B 145, H 250



E27 4x 40W



9 008606 263332



9 008606 263349



9 008606 235322





92727



30931

LED

92727 CONDRA 1

ceiling light; steel, chrome / satin glass, white
 Deckenleuchte; Stahl, chrom / Glas satiniert, weiss
 plafonnier; acier, chrome / verre satiné, blanc

L 470, B 470, H 300



30931 CABO

ceiling light; stainless steel, chrome / satin glass, white, clear
 Deckenleuchte; Edelstahl, chrom / Glas satiniert, weiss, klar
 plafonnier; acier inoxydable, chrome / verre satiné, blanc, transparent

L 290, B 290, H 70

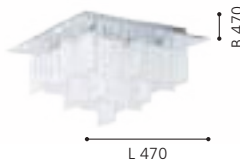
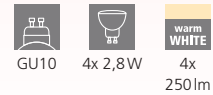



95639

LED



95284



CLEMENTE



95285

95639 ACOLLA

wall/ceiling light; steel, chrome / glass with brilliant glass, white, clear

Wand- / Deckenleuchte; Stahl, chrom / Glas mit Brillantglas, weiss, klar

Applique/Plafonnier; acier, chrome / verre avec verre brillant, blanc, transparent

H 85, Ø 290



3x 3,6W 1110lm

95284 CLEMENTE

ceiling light; steel, chrome / brilliant glass, clear

Deckenleuchte; Stahl, chrom / Brillantglas, klar

plafonnier; acier, chrome / verre brillant, transparent

H 200, Ø 350



E27 2x 60W

95285 CLEMENTE

ceiling light; steel, chrome / brilliant glass, clear

Deckenleuchte; Stahl, chrom / Brillantglas, klar

plafonnier; acier, chrome / verre brillant, transparent

H 205, Ø 450



E27 3x 60W

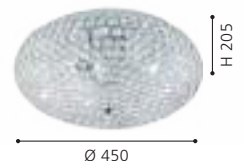
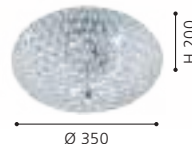



99324

LED



99325

LED



99328

LED

99324 FRADELO 1

wall/ceiling light; steel, black / plastic, brilliant glass, black, clear
Wand- / Deckenleuchte; Stahl, schwarz / Kunststoff, Brillantglas, schwarz, klar
Applique/Plafonnier; acier, noir / plastique, verre brillant, noir, transparent

L 140, B 140, H 60



1x 3,2W 400lm

99325 FRADELO 1

wall/ceiling light; steel, black / plastic, brilliant glass, black, clear
Wand- / Deckenleuchte; Stahl, schwarz / Kunststoff, Brillantglas, schwarz, klar
Applique/Plafonnier; acier, noir / plastique, verre brillant, noir, transparent

L 460, B 140, H 60



3x 3,5W 1200lm

99328 FRADELO 1

ceiling light; steel, black / plastic, brilliant glass, black, clear
Deckenleuchte; Stahl, schwarz / Kunststoff, Brillantglas, schwarz, klar
plafonnier; acier, noir / plastique, verre brillant, noir, transparent

L 520, B 520, H 95



46,5W 5500lm



9 002759 993245

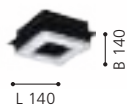

9 002759 993252



9 002759 993283





99327

LED

99327 FRADELO 1

ceiling light; steel, black / plastic, brilliant glass, black, clear
Deckenleuchte; Stahl, schwarz / Kunststoff, Brillantglas, schwarz, klar
plafonnier; acier, noir / plastique, verre brillant, noir, transparent

L 260, B 260, H 85



DESIGN
HIGHLIGHT
DETAIL



95655

LED



95656

LED

95655 FRADELO

wall/ceiling light; steel, chrome / plastic, brilliant glass, chrome, clear

Wand- / Deckenleuchte; Stahl, chrom / Kunststoff, Brillantglas, chrom, klar

Applique/Plafonnier; acier, chrome / plastique, verre brillant, chrome, transparent

L 140, B 140, H 60

LED

warm WHITE



1x 3,2W

400lm

95656 FRADELO

wall/ceiling light; steel, chrome / plastic, brilliant glass, chrome, clear

Wand- / Deckenleuchte; Stahl, chrom / Kunststoff, Brillantglas, chrom, klar

Applique/Plafonnier; acier, chrome / plastique, verre brillant, chrome, transparent

L 460, B 140, H 60

LED

warm WHITE



3x 3,5W

1200lm



9 002759 956554

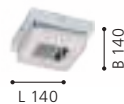

9 002759 956561





95661



95657



95659



95661 FRADELO

ceiling light; steel, chrome / plastic, brilliant glass, chrome, clear
 Deckenleuchte; Stahl, chrom / Kunststoff, Brillantglas, chrom, klar
 plafonnier; acier, chrome / plastique, verre brillant, chrome, transparent

L 520, B 520, H 95



46,5W 5500lm

95657 FRADELO

wall/ceiling light; steel, chrome / plastic, brilliant glass, chrome, clear
 Wand- / Deckenleuchte; Stahl, chrom / Kunststoff, Brillantglas, chrom, klar
 Applique/Plafonnier; acier, chrome / plastique, verre brillant, chrome, transparent

L 280, B 280, H 60



4x 3,5W 1600lm

95659 FRADELO

ceiling light; steel, chrome / plastic, brilliant glass, chrome, clear
 Deckenleuchte; Stahl, chrom / Kunststoff, Brillantglas, chrom, klar
 plafonnier; acier, chrome / plastique, verre brillant, chrome, transparent

L 260, B 260, H 85



4x 2W 920lm 1x 3,5W 400lm



9 002759 956615



9 002759 956578



9 002759 956592





97487

LED



95689, 97487

These luminaires come with high quality brilliant glass.

Diese Leuchten sind mit hochwertigem Brillantglas ausgestattet.

Ces lumières sont fabriquées avec une haute qualité Equipé de verre brillant.



95689



97487 VALLEMARE

wall/ceiling light; aluminium, steel, chrome / plastic, brilliant glass, white, clear

Wand- / Deckenleuchte; Alu, Stahl, chrom / Kunststoff, Brillantglas, weiss, klar

Applique/Plafonnier; aluminium, acier, chrome / plastique, verre brillant, blanc, transparent

H 125, Ø 650



5x 6,6W 4500lm

95689 SORRENTA 1

wall/ceiling light; steel, white / glass with brilliant glass, white, clear

Wand- / Deckenleuchte; Stahl, weiss / Glas mit Brillantglas, weiss, klar

Applique/Plafonnier; acier, blanc / verre avec verre brillant, blanc, transparent

H 95, Ø 315



3x 3,8W 1170lm

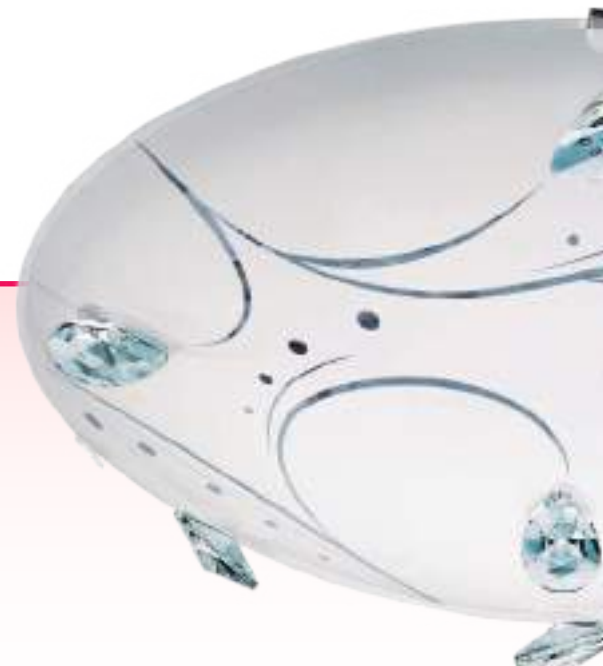

9 002759 974879

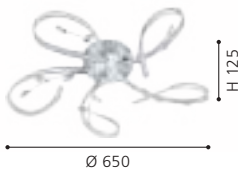

9 002759 956899







98527

LED

incl./inkl./inclus



 TUNABLE WHITE	 STEP DIMMING	 NIGHT LIGHT FUNCTION
--	---	---

98527

98685

1. warmwhite (2700 K/100 %)
2. neutralwhite 3850 K
(2700 K/50 % + 5000 K/50 %)
3. coldwhite (5000 K/100 %)



98685

LED

incl./inkl./inclus



98527 CANICOSA 2

wall/ceiling light; plastic, steel, black, gold / plastic, granules, transparent

Wand- / Deckenleuchte; Kunststoff, Stahl, schwarz, gold / Kunststoff mit Granille, transparent

Applique/Plafonnier; plastique, acier, noir, or / plastique granité, transparent

H 90, Ø 495



24,5 W



3200 lm



Remote



98685 CANICOSA 2

wall/ceiling light; plastic, steel, black, gold / plastic, granules, transparent

Wand- / Deckenleuchte; Kunststoff, Stahl, schwarz, gold / Kunststoff mit Granille, transparent

Applique/Plafonnier; plastique, acier, noir, or / plastique granité, transparent

H 145, Ø 765



4x 4,5 W



2120 lm



3x 4,5 W



1590 lm



4x 2,2 W



1040 lm



Remote



9 002759 985271



9 002759 986858





98487

LED



98023

LED



98488

LED

98023 MONTENOVO

wall/ceiling light; steel, white / glass, white, gold
Wand- / Deckenleuchte; Stahl, weiss / Glas, weiss, gold
Applique/Plafonnier; acier, blanc / verre, blanc, or

H 100, Ø 395



3x 7,3W 2220lm



9 002759 980238



98487 POZONDON

ceiling light; steel, gold-coloured / plastic, white
Deckenleuchte; Stahl, goldfarben / Kunststoff, weiss
plafonnier; acier, or / plastique, blanc

H 100, Ø 380



18W 2300lm



9 002759 984878

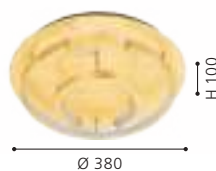

98488 POZONDON

ceiling light; steel, gold-coloured / plastic, white
Deckenleuchte; Stahl, goldfarben / Kunststoff, weiss
plafonnier; acier, or / plastique, blanc

H 120, Ø 520



22,5W 3100lm



9 002759 984885

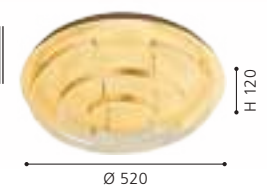



97526



incl./inkl./inclus



97527



incl./inkl./inclus



97528



incl./inkl./inclus



 TUNABLE WHITE 3000 - 5000 K	 DIMMABLE 10 - 100 %	 TIMER FUNCTION off after 30sec.	 NIGHT LIGHT FUNCTION	<u>97526</u>	<u>97541</u>
				<u>97527</u>	<u>97542</u>
				<u>97528</u>	<u>97543</u>

97526 GIRON

ceiling light; steel, white / plastic, white
Deckenleuchte; Stahl, weiss / Kunststoff, weiss
plafonnier; acier, blanc / plastique, blanc

H 75, Ø 570



36W



4300lm



Remote

97527 GIRON

ceiling light; steel, white / plastic, white
Deckenleuchte; Stahl, weiss / Kunststoff, weiss
plafonnier; acier, blanc / plastique, blanc

H 85, Ø 760



54,5W



6500lm



Remote

97528 GIRON

ceiling light; steel, white / plastic, white
Deckenleuchte; Stahl, weiss / Kunststoff, weiss
plafonnier; acier, blanc / plastique, blanc

H 120, Ø 1000



73W



9800lm



Remote



9 002759 975265



Ø 570



9 002759 975272



Ø 760



9 002759 975289



Ø 1000



97541



incl./inkl./inclus



97542



incl./inkl./inclus



97543



incl./inkl./inclus



97541 GIRON-S

ceiling light; steel, white / plastic with crystal effect, white
Deckenleuchte; Stahl, weiss / Kunststoff m.Kristalleffekt, weiss
plafonnier; acier, blanc / plastique avec effet cristal, blanc

H 75, Ø 570



36W



4300lm



Remote

97542 GIRON-S

ceiling light; steel, white / plastic with crystal effect, white
Deckenleuchte; Stahl, weiss / Kunststoff m.Kristalleffekt, weiss
plafonnier; acier, blanc / plastique avec effet cristal, blanc

H 85, Ø 760



54,5W



6500lm



Remote

97543 GIRON-S

ceiling light; steel, white / plastic with crystal effect, white
Deckenleuchte; Stahl, weiss / Kunststoff m.Kristalleffekt, weiss
plafonnier; acier, blanc / plastique avec effet cristal, blanc

H 120, Ø 1000



73W



9800lm



Remote



9 002759 975418

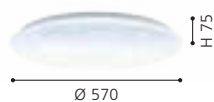

9 002759 975425



9 002759 975432

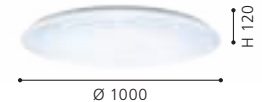



97871



97872



97873



97871 FRANIA

wall/ceiling light; steel, white / plastic, white
Wand- / Deckenleuchte; Stahl, weiss / Kunststoff, weiss
Applique/Plafonnier; acier, blanc / plastique, blanc

H 70, Ø 280



10W



1100lm



9 002759 978716

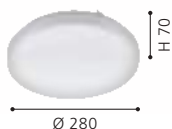

Ø 280

97872 FRANIA

wall/ceiling light; steel, white / plastic, white
Wand- / Deckenleuchte; Stahl, weiss / Kunststoff, weiss
Applique/Plafonnier; acier, blanc / plastique, blanc

H 70, Ø 330



14,6W



1600lm



9 002759 978723



Ø 330

97873 FRANIA

wall/ceiling light; steel, white / plastic, white
Wand- / Deckenleuchte; Stahl, weiss / Kunststoff, weiss
Applique/Plafonnier; acier, blanc / plastique, blanc

H 70, Ø 430



6x 5,5W



3600lm



9 002759 978730



Ø 430



98446



98446 FRANIA

wall/ceiling light; steel, white / plastic, white

Wand- / Deckenleuchte; Stahl, weiss / Kunststoff, weiss

Applique/Plafonnier; acier, blanc / plastique, blanc

H 70, Ø 550



50W



5900lm



9 002759 984465





97877



97878



97879



97877 FRANIA-S

wall/ceiling light; steel, white / plastic with crystal effect, white
Wand- / Deckenleuchte; Stahl, weiss / Kunststoff m.Kristalleffekt, weiss

Applique/Plafonnier; acier, blanc / plastique avec effet cristal, blanc

H 70, Ø 280



10W



1100lm



97878 FRANIA-S

wall/ceiling light; steel, white / plastic with crystal effect, white
Wand- / Deckenleuchte; Stahl, weiss / Kunststoff m.Kristalleffekt, weiss

Applique/Plafonnier; acier, blanc / plastique avec effet cristal, blanc

H 70, Ø 330



14,6W



1600lm



97879 FRANIA-S

wall/ceiling light; steel, white / plastic with crystal effect, white
Wand- / Deckenleuchte; Stahl, weiss / Kunststoff m.Kristalleffekt, weiss

Applique/Plafonnier; acier, blanc / plastique avec effet cristal, blanc

H 70, Ø 430



6x 5,5W



3600lm



9 002759 978778

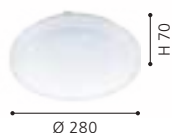

9 002759 978785



9 002759 978792





98448

LED



98448 FRANIA-S

wall/ceiling light; steel, white / plastic with crystal effect, white

Wand- / Deckenleuchte; Stahl, weiss / Kunststoff m. Kristalleffekt, weiss

Applique/Plafonnier; acier, blanc / plastique avec effet cristal, blanc

H 70, Ø 550

LED

50W

warm
WHITE

5900lm

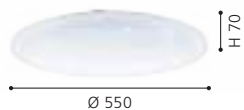



97874



97875



97876



97874 FRANIA

wall/ceiling light; steel, white / plastic, white
Wand- / Deckenleuchte; Stahl, weiss / Kunststoff, weiss
Applique/Plafonnier; acier, blanc / plastique, blanc

L 280, B 280, H 70



10W



1100lm



9 002759 978747

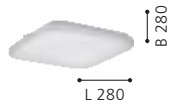

97875 FRANIA

wall/ceiling light; steel, white / plastic, white
Wand- / Deckenleuchte; Stahl, weiss / Kunststoff, weiss
Applique/Plafonnier; acier, blanc / plastique, blanc

L 330, B 330, H 70



14,6W



1600lm



9 002759 978754

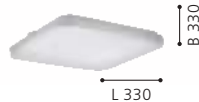

97876 FRANIA

wall/ceiling light; steel, white / plastic, white
Wand- / Deckenleuchte; Stahl, weiss / Kunststoff, weiss
Applique/Plafonnier; acier, blanc / plastique, blanc

L 430, B 430, H 70



6x 5,5W



3600lm



9 002759 978761

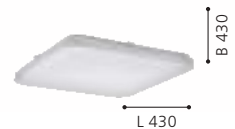



98447



98447 FRANIA

wall/ceiling light; steel, white / plastic, white

Wand- / Deckenleuchte; Stahl, weiss / Kunststoff, weiss

Applique/Plafonnier; acier, blanc / plastique, blanc

L 530, B 530, H 70



50W



5900lm



9 002759 984472





98449

LED



97882

LED



97881

LED



98449 FRANIA-S

wall/ceiling light; steel, white / plastic with crystal effect, white
Wand- / Deckenleuchte; Stahl, weiss / Kunststoff m.Kristalleffekt, weiss

Applique/Plafonnier; acier, blanc / plastique avec effet cristal, blanc

L 530, B 530, H 70

LED

warm
WHITE



50W

5900lm

97883 FRANIA-S

wall/ceiling light; steel, white / plastic with crystal effect, white
Wand- / Deckenleuchte; Stahl, weiss / Kunststoff m.Kristalleffekt, weiss

Applique/Plafonnier; acier, blanc / plastique avec effet cristal, blanc

L 430, B 430, H 70

LED

warm
WHITE



6x 5,5W

3600lm

97882 FRANIA-S

wall/ceiling light; steel, white / plastic with crystal effect, white
Wand- / Deckenleuchte; Stahl, weiss / Kunststoff m.Kristalleffekt, weiss

Applique/Plafonnier; acier, blanc / plastique avec effet cristal, blanc

L 330, B 330, H 70

LED

warm
WHITE



14,6W

1600lm



9 002759 984496



9 002759 978839



9 002759 978822

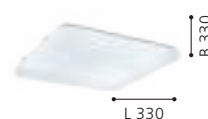



97883

LED



97577

LED

incl./inkl./inclus



97578

LED

incl./inkl./inclus



TUNABLE
WHITE

2700 - 6500 K

STEP
DIMMING

10/25/50/100 %

97577

97578

97881 FRANIA-S

wall/ceiling light; steel, white / plastic with crystal effect, white
Wand- / Deckenleuchte; Stahl, weiss / Kunststoff m. Kristalleffekt, weiss

Applique/Plafonnier; acier, blanc / plastique avec effet cristal, blanc

L 280, B 280, H 70

LED

10W

warm
WHITE

1100lm



9 002759 978815

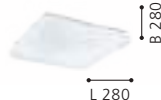

97578 SILERAS

wall/ceiling light; steel, white / plastic with crystal effect, white
Wand- / Deckenleuchte; Stahl, weiss / Kunststoff m. Kristalleffekt, weiss

Applique/Plafonnier; acier, blanc / plastique avec effet cristal, blanc

H 85, Ø 600

LED

31W

tunable
WHITE

4600lm



CONTROL
UNIT

Remote



9 002759 975784



97577 SILERAS

wall/ceiling light; steel, white / plastic with crystal effect, white
Wand- / Deckenleuchte; Stahl, weiss / Kunststoff m. Kristalleffekt, weiss

Applique/Plafonnier; acier, blanc / plastique avec effet cristal, blanc

H 85, Ø 450

LED

20,5W

tunable
WHITE

2800lm



CONTROL
UNIT

Remote



9 002759 975777





98323

LED

incl./inkl./inclus

98324

LED





incl./inkl./inclus



97737

LED

incl./inkl./inclus

 TUNABLE WHITE	 DIMMABLE	 TIMER FUNCTION	 NIGHT LIGHT FUNCTION	98323
	10 - 100 %	off after 30sec.		98324
				97737

98323 LANCIANO 1

wall/ceiling light; steel, white, transparent / plastic with crystal effect, white, chrome

Wand- / Deckenleuchte; Stahl, weiss, transparent / Kunststoff m. Kristalleffekt, weiss, chrom

Applique/Plafonnier; acier, blanc, transparent / plastique avec effet cristal, blanc, chrome

H 75, Ø 400

			
18,8W	2300lm		Remote

98324 LANCIANO 1

wall/ceiling light; steel, white, transparent / plastic with crystal effect, white, chrome

Wand- / Deckenleuchte; Stahl, weiss, transparent / Kunststoff m. Kristalleffekt, weiss, chrom

Applique/Plafonnier; acier, blanc, transparent / plastique avec effet cristal, blanc, chrome

H 80, Ø 560

			
33W	4000lm		Remote

97737 LANCIANO

ceiling light; steel, plastic, white, transparent / plastic with crystal effect, white, silver

Deckenleuchte; Stahl, Kunststoff, weiss, transparent / Kunststoff m. Kristalleffekt, weiss, silber

plafonnier; acier, plastique, blanc, transparent / plastique avec effet cristal, blanc, argent

H 100, Ø 660

			
36W	4300lm		Remote



9 002759 983239



9 002759 983246



9 002759 977375





900598

LED

incl./inkl./inclus



900599

LED

incl./inkl./inclus



900598 LANCIANO 1

ceiling light; steel, wood, white, brown / plastic with crystal effect, white

Deckenleuchte; Stahl, Holz, weiss, braun / Kunststoff m. Kristalleffekt, weiss

plafonnier; acier, bois, blanc, marron / plastique avec effet cristal, blanc

H 70, Ø 380

LED

24W

tunable
WHITE

2600lm



900599 LANCIANO 1

ceiling light; steel, wood, white, brown / plastic with crystal effect, white

Deckenleuchte; Stahl, Holz, weiss, braun / Kunststoff m. Kristalleffekt, weiss

plafonnier; acier, bois, blanc, marron / plastique avec effet cristal, blanc

H 80, Ø 480

LED

35W

tunable
WHITE

4000lm



9 008606 244973



9 008606 244980

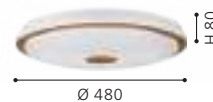



900608

LED



900607

LED

900608 FERENTINO

ceiling light; steel, white / plastic, white
Deckenleuchte; Stahl, weiss / Kunststoff, weiss
plafonnier; acier, blanc / plastique, blanc

H 60, Ø 380



19,5W 2300lm

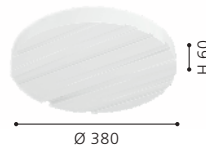

900607 FERENTINO

ceiling light; steel, white / plastic, white
Deckenleuchte; Stahl, weiss / Kunststoff, weiss
plafonnier; acier, blanc / plastique, blanc

H 60, Ø 280



10W 1100lm





900611



900609



900609 FERENTINO

ceiling light; steel, white / plastic, white
Deckenleuchte; Stahl, weiss / Kunststoff, weiss
plafonnier; acier, blanc / plastique, blanc

L 280, B 280, H 60



10W 1100lm

900611 FERENTINO

ceiling light; steel, white / plastic, white
Deckenleuchte; Stahl, weiss / Kunststoff, weiss
plafonnier; acier, blanc / plastique, blanc

L 330, B 330, H 60



14,6W 1600lm



9 008606 245079

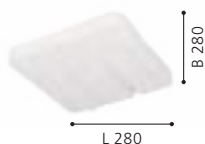

9 008606 245086

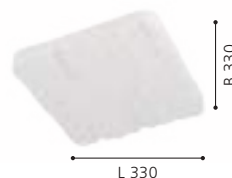



900606

LED

incl./inkl./inclus 



900605

LED

incl./inkl./inclus 



DESIGN
HIGHLIGHT
DETAIL

900605 BATTISTONA

ceiling light; steel, white / plastic, white
Deckenleuchte; Stahl, weiss / Kunststoff, weiss
plafonnier; acier, blanc / plastique, blanc

H 85, Ø 380

LED

4x 2,9W

tunable
WHITE

1280lm

LED

4x 1,45W

tunable
WHITE

640lm



Remote



9 008606 245031



900606 BATTISTONA

ceiling light; steel, white / plastic, white
Deckenleuchte; Stahl, weiss / Kunststoff, weiss
plafonnier; acier, blanc / plastique, blanc

H 100, Ø 480

LED

20,8W

tunable
WHITE

2500lm



Remote



9 008606 245048





99344



99343



99343 BENARIBA

wall/ceiling light; steel, white / plastic, white
Wand- / Deckenleuchte; Stahl, weiss / Kunststoff, weiss
Applique/Plafonnier; acier, blanc / plastique, blanc

H 65, Ø 330



14,6W 1600lm

99344 BENARIBA

wall/ceiling light; steel, white / plastic, white
Wand- / Deckenleuchte; Stahl, weiss / Kunststoff, weiss
Applique/Plafonnier; acier, blanc / plastique, blanc

H 70, Ø 440



22W 2500lm



9 002759 993436



9 002759 993443





96032



96033



96034



96032 COMPETA 1

wall/ceiling light; steel, white / plastic, white, satin nickel
Wand- / Deckenleuchte; Stahl, weiss / Kunststoff, weiss, nickel-
matt
Applique/Plafonnier; acier, blanc / plastique, blanc, nickel mat

H 55, Ø 245



15,6W 1900lm

96033 COMPETA 1

wall/ceiling light; steel, white / plastic, white, satin nickel
Wand- / Deckenleuchte; Stahl, weiss / Kunststoff, weiss, nickel-
matt
Applique/Plafonnier; acier, blanc / plastique, blanc, nickel mat

H 55, Ø 325



18W 2200lm

96034 COMPETA 1

wall/ceiling light; steel, white / plastic, white, satin nickel
Wand- / Deckenleuchte; Stahl, weiss / Kunststoff, weiss, nickel-
matt
Applique/Plafonnier; acier, blanc / plastique, blanc, nickel mat

H 55, Ø 430



20W 2400lm



9 002759 960322



9 002759 960339



9 002759 960346





95679

LED



95682

LED



95684

LED



95679 COMPETA 1

wall/ceiling light; steel, white / plastic, white, silver, clear
 Wand- / Deckenleuchte; Stahl, weiss / Kunststoff, weiss, silber, klar
 Applique/Plafonnier; acier, blanc / plastique, blanc, argent, transparent

L 340, B 340, H 80



21W 2400lm

95682 PALERMO 2

wall/ceiling light; steel, white / plastic, white, chrome
 Wand- / Deckenleuchte; Stahl, weiss / Kunststoff, weiss, chrom
 Applique/Plafonnier; acier, blanc / plastique, blanc, chrome

H 70, Ø 280



15,6W 1900lm

95684 PALERMO 2

wall/ceiling light; steel, white / plastic, white, chrome
 Wand- / Deckenleuchte; Stahl, weiss / Kunststoff, weiss, chrom
 Applique/Plafonnier; acier, blanc / plastique, blanc, chrome

H 60, Ø 410



20W 2400lm



9 002759 956790

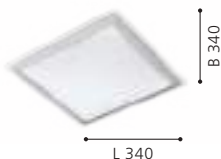

9 002759 956820



9 002759 956844





96023

LED



900149

LED



900335

LED

96023 CAPASSO

wall/ceiling light; steel, white / plastic, white, chrome
Wand- / Deckenleuchte; Stahl, weiss / Kunststoff, weiss, chrom
Applique/Plafonnier; acier, blanc / plastique, blanc, chrome

H 65, Ø 340

LED

18W

warm
WHITE

2200lm



900149 CAPASSO

wall/ceiling light; steel, white / plastic, white, black
Wand- / Deckenleuchte; Stahl, weiss / Kunststoff, weiss, schwarz
Applique/Plafonnier; acier, blanc / plastique, blanc, noir

H 60, Ø 340

LED

14,6W

warm
WHITE

1600lm



900335 CAPASSO

wall/ceiling light; steel, white / plastic, white, black
Wand- / Deckenleuchte; Stahl, weiss / Kunststoff, weiss, schwarz
Applique/Plafonnier; acier, blanc / plastique, blanc, noir

H 60, Ø 480

LED

19,5W

warm
WHITE

2200lm



9 002759 960230



9 008606 243471



9 008606 243488





900612



900613



900612 RENDE

ceiling light; steel, white / plastic, white, gold
Deckenleuchte; Stahl, weiss / Kunststoff, weiss, gold
plafonnier; acier, blanc / plastique, blanc, or

H 60, Ø 380



19,5W 2300lm

900613 RENDE

ceiling light; steel, white / plastic, white, silver
Deckenleuchte; Stahl, weiss / Kunststoff, weiss, silber
plafonnier; acier, blanc / plastique, blanc, argent

L 380, B 380, H 60



19,5W 2300lm



9 008606 245093



9 008606 245109





900498

LED



900499

LED



900501

LED



900498 NIEVES 1

wall/ceiling light; steel, white / plastic, white, gold
Wand- / Deckenleuchte; Stahl, weiss / Kunststoff, weiss, gold
Applique/Plafonnier; acier, blanc / plastique, blanc, or

H 60, Ø 310

LED

warm
WHITE
10W 1100lm



900499 NIEVES 1

wall/ceiling light; steel, white / plastic, white, gold
Wand- / Deckenleuchte; Stahl, weiss / Kunststoff, weiss, gold
Applique/Plafonnier; acier, blanc / plastique, blanc, or

H 65, Ø 410

LED

warm
WHITE
19,5W 2300lm



900501 NIEVES 1

wall/ceiling light; steel, white / plastic, white, gold
Wand- / Deckenleuchte; Stahl, weiss / Kunststoff, weiss, gold
Applique/Plafonnier; acier, blanc / plastique, blanc, or

H 70, Ø 510

LED

warm
WHITE
7x 4,4W 3710lm



9 008606 239634



9 008606 239641

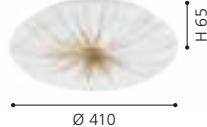

9 008606 239658





99699

LED



98325

LED



98326

LED

99699 NIEVES

wall/ceiling light; steel, white / plastic, white, silver
Wand- / Deckenleuchte; Stahl, weiss / Kunststoff, weiss, silber
Applique/Plafonnier; acier, blanc / plastique, blanc, argent

H 60, Ø 310



10W 1100lm

98325 NIEVES

wall/ceiling light; steel, white / plastic, white, silver
Wand- / Deckenleuchte; Stahl, weiss / Kunststoff, weiss, silber
Applique/Plafonnier; acier, blanc / plastique, blanc, argent

H 65, Ø 410



19,5W 2300lm

98326 NIEVES

wall/ceiling light; steel, white / plastic, white, silver
Wand- / Deckenleuchte; Stahl, weiss / Kunststoff, weiss, silber
Applique/Plafonnier; acier, blanc / plastique, blanc, argent

H 70, Ø 510



7x 4,4W 3710lm



9 002759 996994

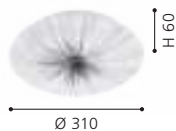

9 002759 983253

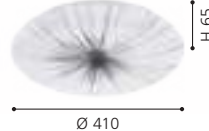

9 002759 983260

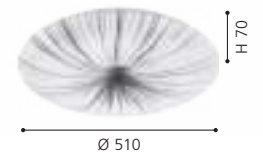



99406



99407



98603



99406 PESCAITO

wall/ceiling light; steel, black / plastic, white, gold
Wand- / Deckenleuchte; Stahl, schwarz / Kunststoff, weiss, gold
Applique/Plafonnier; acier, noir / plastique, blanc, or

H 65, Ø 280



10W



1100lm



99407 PESCAITO

wall/ceiling light; steel, black / plastic, white, gold
Wand- / Deckenleuchte; Stahl, schwarz / Kunststoff, weiss, gold
Applique/Plafonnier; acier, noir / plastique, blanc, or

H 65, Ø 380



19,5W



2300lm



98603 MUSURITA

ceiling light; plastic, steel, black / plastic, white
Deckenleuchte; Kunststoff, Stahl, schwarz / Kunststoff, weiss
plafonnier; plastique, acier, noir / plastique, blanc

H 60, Ø 340



14,6W



1600lm



9 002759 994068



9 002759 994075



9 002759 986032





98604



98601



98602



98604 MUSURITA

ceiling light; plastic, steel, black / plastic, white
Deckenleuchte; Kunststoff, Stahl, schwarz / Kunststoff, weiss
plafonnier; plastique, acier, noir / plastique, blanc

H 75, Ø 440



6x 5,5 W 3600 lm



9 002759 986049



98601 MUSURITA

ceiling light; plastic, steel, natural wooden effect / plastic, white
Deckenleuchte; Kunststoff, Stahl, Holzoptik natur / Kunststoff, weiss
plafonnier; plastique, acier, aspect bois naturel / plastique, blanc

H 60, Ø 340



14,6 W 1600 lm



9 002759 986018

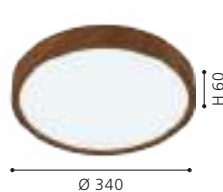

98602 MUSURITA

ceiling light; plastic, steel, natural wooden effect / plastic, white
Deckenleuchte; Kunststoff, Stahl, Holzoptik natur / Kunststoff, weiss
plafonnier; plastique, acier, aspect bois naturel / plastique, blanc

H 75, Ø 440



6x 5,5 W 3600 lm



9 002759 986025

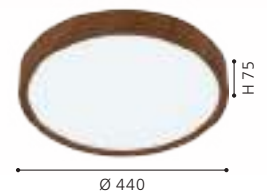



99782

LED

incl./inkl./inclus



99783

LED

incl./inkl./inclus



99779

LED

incl./inkl./inclus



99782 LAURITO

ceiling light; steel, white / plastic, grey, white
Deckenleuchte; Stahl, weiss / Kunststoff, grau, weiss
plafonnier; acier, blanc / plastique, gris, blanc

H 70, Ø 490



24W



2600lm



Remote

99783 LAURITO

ceiling light; steel, white / plastic, black, white
Deckenleuchte; Stahl, weiss / Kunststoff, schwarz, weiss
plafonnier; acier, blanc / plastique, noir, blanc

H 70, Ø 490



24W



2600lm



Remote

99779 SELUCI

ceiling light; steel, white / plastic, white, clear
Deckenleuchte; Stahl, weiss / Kunststoff, weiss, klar
plafonnier; acier, blanc / plastique, blanc, transparent

H 80, Ø 490



4x 10W



4600lm



Remote



9 002759 997823



9 002759 997830



9 002759 997793





99781

LED

incl./inkl./inclus



99781 SELUCI

ceiling light; steel, black / plastic, white, clear
Deckenleuchte; Stahl, schwarz / Kunststoff, weiss, klar
plafonnier; acier, noir / plastique, blanc, transparent

H 80, Ø 490



4x 10W



4600lm



Remote



9 002759 997816



SELUCI

Convenient light effect due to the indirect illumination.

Angenehmer Lichteffect durch indirekte Beleuchtung.

Effet de lumière pratique en raison de l'éclairage indirect.





99623

LED





99621



99622



99623 VALCASOTTO

ceiling light; steel, mocha-coloured / plastic, white
 Deckenleuchte; Stahl, Mokkafarben / Kunststoff, weiss
 plafonnier; acier, café / plastique, blanc

H 75, Ø 370



20W 2400lm



9 002759 996239



99621 VALCASOTTO

ceiling light; steel, black / plastic, white
 Deckenleuchte; Stahl, schwarz / Kunststoff, weiss
 plafonnier; acier, noir / plastique, blanc

H 75, Ø 370



20W 2400lm



9 002759 996215



99622 VALCASOTTO

ceiling light; steel, brown / plastic, white
 Deckenleuchte; Stahl, braun / Kunststoff, weiss
 plafonnier; acier, marron / plastique, blanc

H 75, Ø 370



20W 2400lm



9 002759 996222





900795



900796



900795 LUPPINERIA

ceiling light; steel, black / plastic, white
 Deckenleuchte; Stahl, schwarz / Kunststoff, weiss
 plafonnier; acier, noir / plastique, blanc

H 95, Ø 385



20W 2400lm

900796 LUPPINERIA

ceiling light; steel, matte brass / plastic, white
 Deckenleuchte; Stahl, messing-matt / Kunststoff, weiss
 plafonnier; acier, laiton mat / plastique, blanc

H 95, Ø 385



20W 2400lm



9 008606 267927



9 008606 267934

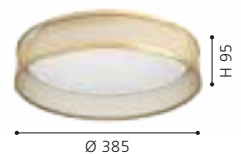



900463



900464



900463 LUPPINERIA

ceiling light; steel, plastic, sandy, white / wood, brown
 Deckenleuchte; Stahl, Kunststoff, sandfarben, weiss / Holz, braun
 plafonnier; acier, plastique, couleur sable, blanc / bois, marron

H 80, Ø 380



20W 2400lm

900464 LUPPINERIA

ceiling light; plastic, steel, white / wood, brown
 Deckenleuchte; Kunststoff, Stahl, weiss / Holz, braun
 plafonnier; plastique, acier, blanc / bois, marron

H 80, Ø 380



20W 2400lm



9 008606 244027



9 008606 244034





900797

LED



900857

LED



DESIGN
HIGHLIGHT
DETAIL

900797 LUPPINERIA

ceiling light; wood, steel, brown, white / plastic, white
Deckenleuchte; Holz, Stahl, braun, weiss / Kunststoff, weiss
plafonnier; bois, acier, marron, blanc / plastique, blanc

H 95, Ø 450



20W 2400lm

900857 PENJAMO 1

ceiling light; steel, wood, black, brown / plastic, white
Deckenleuchte; Stahl, Holz, schwarz, braun / Kunststoff, weiss
plafonnier; acier, bois, noir, marron / plastique, blanc

H 65, Ø 465



20W 2400lm



9 008606 267019

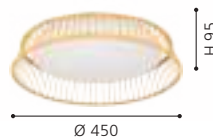

9 008606 271207





99703



99704



99703 PENJAMO

ceiling light; steel, black / plastic with crystal effect, white
Deckenleuchte; Stahl, schwarz / Kunststoff m. Kristalleffekt, weiss
plafonnier; acier, noir / plastique avec effet cristal, blanc

H 60, Ø 465



3x 7,3W 2010lm

99704 PENJAMO

ceiling light; steel, mocha-coloured / plastic with crystal effect, white
Deckenleuchte; Stahl, Mokkafarben / Kunststoff m. Kristalleffekt, weiss
plafonnier; acier, café / plastique avec effet cristal, blanc

H 60, Ø 465



3x 7,3W 2010lm



9 002759 997038



9 002759 997045





900601

LED



900601 CALAGRANO

ceiling light; steel, black / plastic, white
Deckenleuchte; Stahl, schwarz / Kunststoff, weiss
plafonnier; acier, noir / plastique, blanc

H 60, Ø 380



11,5W



1500lm



10W



1400lm



9 008606 244997





900602

LED

incl./inkl./inclus



900863

LED



900864

LED

900602 CALAGRANO

ceiling light; steel, black / plastic, white
Deckenleuchte; Stahl, schwarz / Kunststoff, weiss
plafonnier; acier, noir / plastique, blanc

L 375, B 375, H 60



11 W 1600 lm 10 W 1400 lm



9 008606 245000



900863 PALAGIANO

ceiling light; steel, white / plastic, steel, satin finish, white
Deckenleuchte; Stahl, weiss / Kunststoff, Stahl, satiniert, weiss
plafonnier; acier, blanc / plastique, acier, satiné, blanc

H 55, Ø 300



14,7 W 2100 lm



9 008606 264087



900864 PALAGIANO

ceiling light; steel, white / plastic, steel, satin finish, white
Deckenleuchte; Stahl, weiss / Kunststoff, Stahl, satiniert, weiss
plafonnier; acier, blanc / plastique, acier, satiné, blanc

H 55, Ø 380



21 W 3100 lm



9 008606 264094





32051



32052



32053



32051 PALAGIANO 1

ceiling light; steel, white / plastic, steel, satin finish, white
Deckenleuchte; Stahl, weiss / Kunststoff, Stahl, satiniert, weiss
plafonnier; acier, blanc / plastique, acier, satiné, blanc

H 50, Ø 300



14,7W 2100lm

32052 PALAGIANO 1

ceiling light; steel, white / plastic, steel, satin finish, white
Deckenleuchte; Stahl, weiss / Kunststoff, Stahl, satiniert, weiss
plafonnier; acier, blanc / plastique, acier, satiné, blanc

H 50, Ø 380



14,7W 2200lm

32053 PALAGIANO 1

ceiling light; steel, white / plastic, steel, satin finish, white
Deckenleuchte; Stahl, weiss / Kunststoff, Stahl, satiniert, weiss
plafonnier; acier, blanc / plastique, acier, satiné, blanc

H 50, Ø 480



21W 3200lm



9 002759 320515



9 002759 320522



9 002759 320539





99397

LED



99398

LED

99397 MENTALURGIA

wall/ceiling light; steel, white, chrome / plastic, white
Wand- / Deckenleuchte; Stahl, weiss, chrom / Kunststoff, weiss
Applique/Plafonnier; acier, blanc, chrome / plastique, blanc

L 495, B 465, H 65

11 W	1400lm	9,8W	1300lm	8,5W	1250lm
6 W	850lm	5W	600lm		



9 002759 993979



99398 MENTALURGIA

wall/ceiling light; steel, white, chrome / plastic, white
Wand- / Deckenleuchte; Stahl, weiss, chrom / Kunststoff, weiss
Applique/Plafonnier; acier, blanc, chrome / plastique, blanc

L 490, B 490, H 65

12 W	1750lm	11 W	1600lm	7,5W	1050lm
5,5W	750lm	4,4W	550lm		



9 002759 993986



MENTALURGIA

The light color of the luminaires can be controlled via the wall switch.

Über den Wandschalter kann die Lichtfarbe der Leuchten gesteuert werden.

L'interrupteur mural permet de contrôler la couleur de la lumière des luminaires.



81635



83404



81636

81635 ELLA

wall/ceiling light; steel, white / matte-opal glass, white
Wand- / Deckenleuchte; Stahl, weiss / Glas opal-matt, weiss
Applique/Plafonnier; acier, blanc / verre opale mat, blanc

H 92, Ø 200



E27



1x 60W

81636 ELLA

wall/ceiling light; steel, white / matte-opal glass, white
Wand- / Deckenleuchte; Stahl, weiss / Glas opal-matt, weiss
Applique/Plafonnier; acier, blanc / verre opale mat, blanc

H 117, Ø 280



E27



1x 60W

83404 ELLA

wall/ceiling light; steel, white / matte-opal glass, white
Wand- / Deckenleuchte; Stahl, weiss / Glas opal-matt, weiss
Applique/Plafonnier; acier, blanc / verre opale mat, blanc

H 127, Ø 350



E27



2x 60W



9 002759 816353



9 002759 816360



9 002759 834043





94973

94973 DURELO

ceiling light; plastic, white / glass, white
Deckenleuchte; Kunststoff, weiss / Glas, weiss
plafonnier; plastique, blanc / verre, blanc

H 195, Ø 160



E27



1x 28W



9 002759 949730





82942



83155



83153

82942 PLANET

wall/ceiling light; steel, satin nickel / satin glass, white, clear
Wand- / Deckenleuchte; Stahl, nickel-matt / Glas satiniert, weiss, klar
Applique/Plafonnier; acier, nickel mat / verre satiné, blanc, transparent

H 85, Ø 290



E27



1x 25W

83155 PLANET 1

wall/ceiling light; steel, chrome / painted glass, white, clear
Wand- / Deckenleuchte; Stahl, chrom / Glas lackiert, weiss, klar
Applique/Plafonnier; acier, chrome / verre laqué, blanc, transparent

H 85, Ø 290



E27



1x 25W

83153 PLANET 1

wall/ceiling light; steel, white / painted glass, white, clear
Wand- / Deckenleuchte; Stahl, weiss / Glas lackiert, weiss, klar
Applique/Plafonnier; acier, blanc / verre laqué, blanc, transparent

H 85, Ø 290



E27



1x 25W



9 002759 829421



Ø 290



9 002759 831554



Ø 290



9 002759 831530



Ø 290



83156



83154

83156 PLANET 1

wall light; steel, chrome / painted glass, white, clear
 Wandleuchte; Stahl, chrom / Glas lackiert, weiss, klar
 Applique; acier, chrome / verre laqué, blanc, transparent

L 290, H 145, A 85



83154 PLANET 1

wall light; steel, white / painted glass, white, clear
 Wandleuchte; Stahl, weiss / Glas lackiert, weiss, klar
 Applique; acier, blanc / verre laqué, blanc, transparent

L 290, H 145, A 85



9 002759 831561



9 002759 831547





83157



83159

83157 PLANET 1

wall/ceiling light; steel, brass / painted glass, white, clear
Wand- / Deckenleuchte; Stahl, messing / Glas lackiert, weiss, klar
Applique/Plafonnier; acier, laiton / verre laqué, blanc, transparent

H 85, Ø 290



E27



1x 25W



9 002759 831578



Ø 290

83159 PLANET 1

wall/ceiling light; steel, black / painted glass, white, clear
Wand- / Deckenleuchte; Stahl, schwarz / Glas lackiert, weiss, klar
Applique/Plafonnier; acier, noir / verre laqué, blanc, transparent

H 85, Ø 290



E27



1x 25W



9 002759 831592



Ø 290

83162 PLANET 1

wall/ceiling light; steel, satin nickel / painted glass, white, clear
Wand- / Deckenleuchte; Stahl, nickel-matt / Glas lackiert, weiss, klar
Applique/Plafonnier; acier, nickel mat / verre laqué, blanc, transparent

H 85, Ø 290



E27



1x 25W



9 002759 831622



Ø 290



83162



83163

83163 PLANET 1

wall light; steel, satin nickel / painted glass, white, clear
Wandleuchte; Stahl, nickel-matt / Glas lackiert, weiss, klar
Applique; acier, nickel mat / verre laqué, blanc, transparent

L 290, H 145, A 85



E27



1x 60W



9 002759 831639

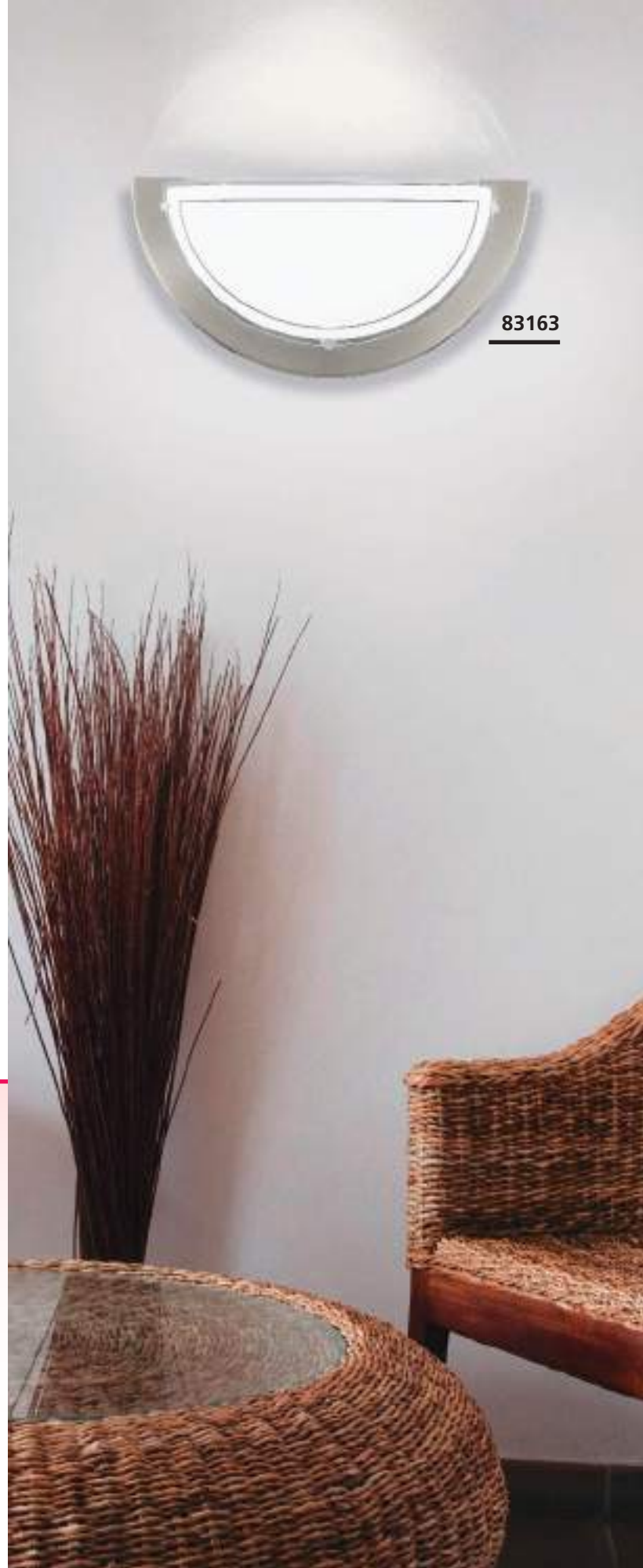



96117

LED





96089

LED



96111

LED

96117 MARGITTA 1

wall/ceiling light; steel, white / glass, white, black, clear
Wand- / Deckenleuchte; Stahl, weiss / Glas, weiss, schwarz, klar
Applique/Plafonnier; acier, blanc / verre, blanc, noir, transparent

H 95, Ø 315



3x 3,6W 1110lm



9 002759 961176



Ø 315

96089 MARGITTA 1

wall/ceiling light; steel, white / glass, white granules, clear
Wand- / Deckenleuchte; Stahl, weiss / Glas, granille weiss, klar
Applique/Plafonnier; acier, blanc / verre, blanc granille, transparent

H 70, Ø 250



3x 3,6W 960lm



9 002759 960896



Ø 250

96111 MARGITTA 1

wall/ceiling light; steel, white / glass, white granules, clear
Wand- / Deckenleuchte; Stahl, weiss / Glas, granille weiss, klar
Applique/Plafonnier; acier, blanc / verre, blanc granille, transparent

H 95, Ø 315



3x 3,6W 960lm



9 002759 961114



Ø 315



89248



89239

89248 MARS 1

wall/ceiling light; steel, white / satin glass, white, silver
 Wand- / Deckenleuchte; Stahl, weiss / Glas satiniert, weiss, silber
 Applique/Plafonnier; acier, blanc / verre satiné, blanc, argent

H 70, Ø 250



E27 1x 25W



9 002759 892487



Ø 250

89239 MARS 1

wall/ceiling light; steel, white / satin glass, sunbeam motif
 Wand- / Deckenleuchte; Stahl, weiss / Glas satiniert, Motiv Strahlen
 Applique/Plafonnier; acier, blanc / verre satiné, motif «rayons»

H 70, Ø 250



E27 1x 25W



9 002759 892395



Ø 250



80263



80264



89238

80264 MARS

wall/ceiling light; steel, white / satin glass, leaf motif
Wand- / Deckenleuchte; Stahl, weiss / Glas satiniert, Motiv Blätter
Applique/Plafonnier; acier, blanc / verre satiné, motif «feuilles»

H 70, Ø 250



9 002759 802646



Ø 250

80263 MARS

wall/ceiling light; steel, white / satin glass, triangle motif
Wand- / Deckenleuchte; Stahl, weiss / Glas satiniert, Motiv Dreiecke
Applique/Plafonnier; acier, blanc / verre satiné, motif «triangles»

H 70, Ø 250



9 002759 802639



Ø 250

89238 MARS 1

wall/ceiling light; steel, white / satin glass, rose motif
Wand- / Deckenleuchte; Stahl, weiss / Glas satiniert, Motiv Rose
Applique/Plafonnier; acier, blanc / verre satiné, motif «rose»

H 70, Ø 250



9 002759 892388



Ø 250



80265



7186



7184

80265 MARS

wall/ceiling light; steel, white / satin glass, white
Wand- / Deckenleuchte; Stahl, weiss / Glas satiniert, weiss
Applique/Plafonnier; acier, blanc / verre satiné, blanc

H 70, Ø 250



E27



1x 25W



9 002759 802653



Ø 250

7186 SALOME

wall/ceiling light; steel, chrome / alabaster glass, white
Wand- / Deckenleuchte; Stahl, chrom / Glas alabaster, weiss
Applique/Plafonnier; acier, chrome / verre albâtre, blanc

H 90, Ø 300



E27



1x 25W



9 002759 718602



Ø 300

7184 SALOME

wall/ceiling light; steel, chrome / alabaster glass, white
Wand- / Deckenleuchte; Stahl, chrom / Glas alabaster, weiss
Applique/Plafonnier; acier, chrome / verre albâtre, blanc

H 110, Ø 400



E27



2x 25W



9 002759 718404



Ø 400



7188

7188 SALOME

wall light; steel, chrome / alabaster glass, white
Wandleuchte; Stahl, chrom / Glas alabaster, weiss
Applique; acier, chrome / verre albâtre, blanc

L 300, H 150, A 90



E27



1x 60W



9 002759 718800



SALOME

These luminaires have a beautiful alabaster glass.

Diese Leuchten besitzen ein wunderschönes Alabasterglas.

Ces luminaires ont un beau verre d'albâtre.





95672



90043

DESIGN
HIGHLIGHT
DETAIL

95672 MAGITTA 1

wall/ceiling light; steel, white / glass, white, clear
Wand- / Deckenleuchte; Stahl, weiss / Glas, weiss, klar
Applique/Plafonnier; acier, blanc / verre, blanc, transparent

H 80, Ø 250



3x 3,6W 1110lm

90043 SCALEA 1

wall/ceiling light; steel, white / satin glass, white with decoration
Wand- / Deckenleuchte; Stahl, weiss / Glas satiniert, weiss m.Dekor
Applique/Plafonnier; acier, blanc / verre satiné, blanc avec décor

H 100, Ø 315



E27 1x 25W



9 002759 956721



Ø 250



9 002759 900434



Ø 315



83132



83119



84028

83132 GRAFIK

wall/ceiling light; steel / satin glass, line motif
Wand- / Deckenleuchte; Stahl / Glas satiniert, Motiv Linien
Applique/Plafonnier; acier / verre satiné, motif «lignes»

L 180, H 210, A 85



E27 1x 60W



9 002759 831325

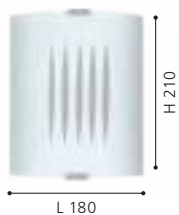

84028 GRAFIK

wall/ceiling light; steel, silver / satin glass, white
Wand- / Deckenleuchte; Stahl, silber / Glas satiniert, weiss
Applique/Plafonnier; acier, argent / verre satiné, blanc

L 180, H 210, A 85



E27 1x 60W



9 002759 840280



83119 NEMO

wall light; steel, satin nickel / matte-opal glass, white
Wandleuchte; Stahl, nickel-matt / Glas opal-matt, weiss
Applique; acier, nickel mat / verre opale mat, blanc

L 150, H 320, A 95



E27 1x 25W



9 002759 831196





DESIGN
HIGHLIGHT
DETAIL



82741



86712

86712 MESTRE

wall/ceiling light; steel, antique brown, gold / chalked glass, beige
Wand- / Deckenleuchte; Stahl, antik-braun, gold / Glas gekalkt, beige
Applique/Plafonnier; acier, marron antique, or / verre chaulé, beige
H 133, Ø 395



9 002759 867126



82741 IMPERIAL

wall/ceiling light; cast metal, bronzed / satin glass, white
Wand- / Deckenleuchte; Metallguss, brüniert / Glas satiniert, weiss
Applique/Plafonnier; fonte métallique, brun / verre satiné, blanc

H 140, Ø 310



9 002759 827410





89115



86715



87793

89115 ALMERA

wall light; steel, antique brown / glass, champagne
Wandleuchte; Stahl, antik-braun / Glas, champagner
Applique; acier, marron antique / verre, champagne

L 180, H 250, A 75

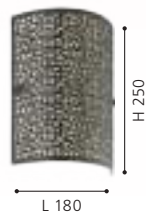

86715 MESTRE

wall light; steel, antique brown, gold / chalked glass, beige
Wandleuchte; Stahl, antik-braun, gold / Glas gekalkt, beige
Applique; acier, marron antique, or / verre chaulé, beige

L 300, H 335, A 160

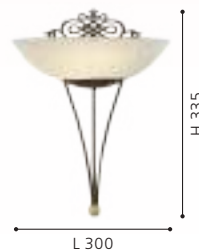

87793 PASCAL 1

wall light; steel, antique brown / chalked glass, beige
Wandleuchte; Stahl, antik-braun / Glas gekalkt, beige
Applique; acier, marron antique / verre chaulé, beige

L 180, H 480, A 120





90737

90737, 90697

Rustic luminaire series with appealing leaf decor

Rustikale Leuchtenserie mit ansprechendem Blätterdekor

Série de luminaires rustique avec un décor de feuille plaisant



90697

90737 CAMPANIA

ceiling light; steel, antique brown, gold / chalked glass, white
Deckenleuchte; Stahl, antik-braun, gold / Glas gekalkt, weiss
plafonnier; acier, marron antique, or / verre chaulé, blanc

H 115, Ø 775



G4 15x 10W

90697 GERBERA 1

ceiling light; steel, antique brown, gold / satin glass, white
Deckenleuchte; Stahl, antik-braun, gold / Glas satiniert, weiss
plafonnier; acier, marron antique, or / verre satiné, blanc

H 90, Ø 780



G9 6x 33W

92143 COLTI

ceiling light; steel, antique brown / satin glass, white painted
Deckenleuchte; Stahl, antik-braun / Glas satiniert, weiss lackiert
plafonnier; acier, marron antique / verre satiné, blanc laqué

H 95, Ø 350



E27 2x 25W



9 002759 907372



9 002759 906979

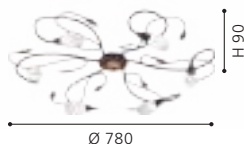

9 002759 921439





92143





97886



99348

Matching fabric luminaires
can be found from page 130.

Passende Stoffleuchten finden
Sie ab Seite 130.

Vous trouverez les luminaires à tissu
assorties à partir de la page 130.

97886 SAN PERI

wall light; steel, black
Wandleuchte; Stahl, schwarz
Applique; acier, noir

L 130, B 300, H 210



E27 1x 10W



9 002759 978860



99348 STAITI 1

wall light; steel, black / fabric, black
Wandleuchte; Stahl, schwarz / Textil, schwarz
Applique; acier, noir / tissu, noir

L 160, H 240, A 500

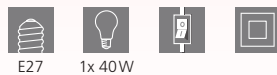

E27 1x 40W



9 002759 993481

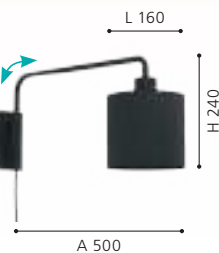



99348

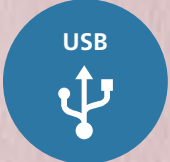

96567



TAZZOLI

These luminaires have a USB-connection.

Diese Leuchten verfügen über einen USB-Anschluss.

Ces luminaires disposent d'une connexion USB.



USB



96566

LED

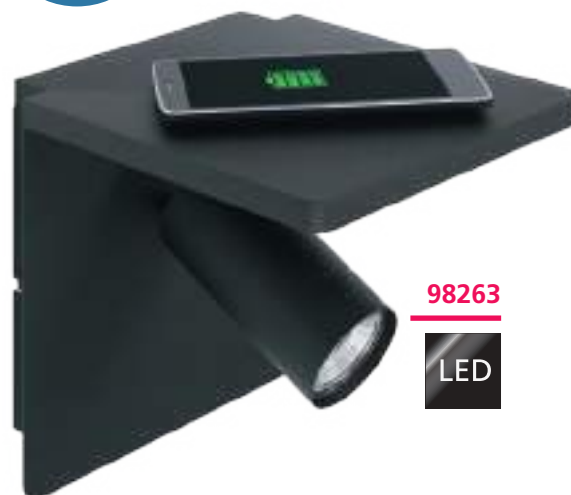

98263

LED

96567 TAZZOLI

wall light; steel, plastic, satin nickel, black
Wandleuchte; Stahl, Kunststoff, nickel-matt, schwarz
Applique; acier, plastique, nickel mat, noir

L 65, H 300, A 160



3,8W 320lm



9 002759 965679



96566 TAZZOLI

wall light; steel, plastic, white
Wandleuchte; Stahl, Kunststoff, weiss
Applique; acier, plastique, blanc

L 65, H 300, A 160



3,8W 320lm



9 002759 965662



98263 CIGLIE

wall light; aluminium, steel, black
Wandleuchte; Alu, Stahl, schwarz
Applique; aluminium, acier, noir

L 180, H 180, A 210



GU10 1x 4,5W 1x 345lm



9 002759 982638





99595



99595

These simple, modern luminaires serve not only as a source of light, but also as a wardrobe. They can be mounted directly in the wall outlet, a cable with switch is automatically supplied.

Diese schlichten, modernen Leuchten dienen nicht nur als Lichtquelle, sondern auch als Garderobe. Sie können direkt im Wandauslass montiert werden, ein Kabel mit Schalter wird automatisch mitgeliefert.

Ces luminaires sobres et modernes ne servent pas seulement de source de lumière, mais aussi de portemanteau. Ils peuvent être montés directement dans le diffuseur mural, un câble avec interrupteur est automatiquement fourni.

99595 CARTIGNANO

wall light; steel, black / plastic, white
 Wandleuchte; Stahl, schwarz / Kunststoff, weiss
 Applique; acier, noir / plastique, blanc

L 780, H 180, A 35



7,8W



900lm



9 002759 995959

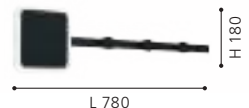



99596



99596 CIVITATE

wall light; steel, wood, black, brown
Wandleuchte; Stahl, Holz, schwarz, braun
Applique; acier, bois, noir, marron

L 760, B 100, H 85



18W 1900lm



99596

LED wall luminaires CIVITATE consist of a rectangular black metal body with rounded corners. Thanks to the five holders made of brown rubber wood, the wall luminaires offer enough space for jackets as well as coats and can thus be optimally used as an illuminated coat rack. The luminaires provide pleasant warm white light, creating indirect lighting in the entrance area. The minimalist luminaires round off modern interior styles and are conveniently switched on and off via a switch on the cable.

Die LED Wandleuchten CIVITATE bestehen aus einem rechteckigen, schwarzen Metall-Körper mit abgerundeten Ecken. Dank der fünf Halterungen aus braunem Gummibaumholz bieten die Wandlampen genügend Platz für Jacken sowie Mäntel und kann so optimal als beleuchtete Garderobe genutzt werden. Die Leuchten spenden angenehmes warmweißes Licht und schaffen so eine indirekte Beleuchtung im Eingangsbereich. Die minimalistischen Leuchten runden moderne Einrichtungsstile ab und sind bequem über einen Schalter am Kabel ein- und ausschaltbar.

Les appliques LED CIVITATE se composent d'un corps rectangulaire en métal noir aux coins arrondis. Grâce aux cinq supports en bois d'hévéa brun, les appliques offrent suffisamment de place pour les vestes et les manteaux et peuvent ainsi être utilisées de manière optimale comme portemanteau éclairé. Les luminaires diffusent une agréable lumière blanche chaude et créent ainsi un éclairage indirect dans la zone d'entrée. Les luminaires minimalistes complètent les styles d'aménagement modernes et s'allument et s'éteignent facilement grâce à un interrupteur sur le câble.



900525

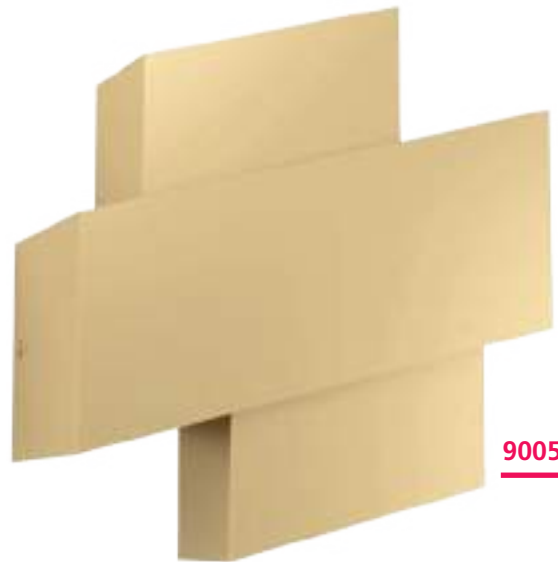

900526

900525 TIMPAROSSA

wall light; steel, white
Wandleuchte; Stahl, weiss
Applique; acier, blanc

L 255, H 220, A 105



E27



1x 40W



9 008606 244539

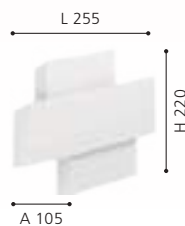

900526 TIMPAROSSA

wall light; steel, gold-coloured
Wandleuchte; Stahl, goldfarben
Applique; acier, or

L 255, H 220, A 105



E27



1x 40W



9 008606 244546

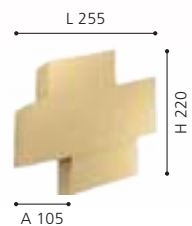



900717

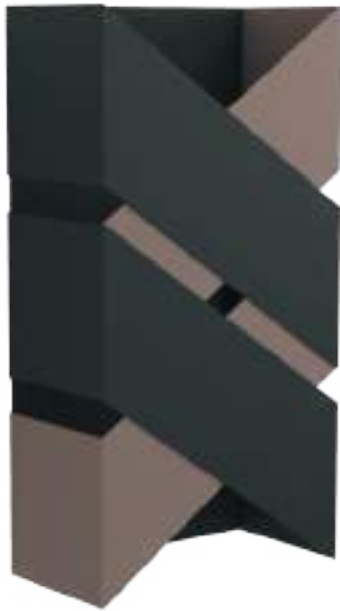

99689



98841



900717 ALAMILO

wall light; steel, white / wood, brown
Wandleuchte; Stahl, weiss / Holz, braun
Applique; acier, blanc / bois, marron

Ø 220, A 35



9,2W

99689 GURARE

wall light; steel, black, mocha-coloured
Wandleuchte; Stahl, schwarz, mokkafarben
Applique; acier, noir, café

L 125, H 240, A 85

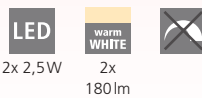

2x 2,5W

2x 180lm

98841 ZINACUA

wall light; steel, silver
Wandleuchte; Stahl, silber
Applique; acier, argent

L 225, H 310, A 85

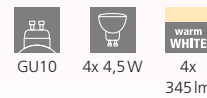

GU10

4x 4,5W

4x 345lm



9 008606 256969



Ø 220



9 002759 996895



L 125

H 240

A 85



9 002759 988418

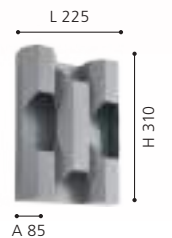

L 225

H 310

A 85



99087



99086



900325



ZUBIALDE

The front panel of the luminaires can be swiveled. Thus, the light pattern can be adjusted individually.

Die Frontplatte der Leuchten ist schwenkbar. Somit kann das Lichtbild individuell eingestellt werden.

La plaque frontale des luminaires est orientable. Ainsi, l'image lumineuse peut être réglée individuellement.



99087 ZUBIALDE

wall light; aluminium, steel, black, white
Wandleuchte; Alu, Stahl, schwarz, weiss
Applique; aluminium, acier, noir, blanc

L 360, H 80, A 50



12W 1550lm



9 002759 990879



99086 ZUBIALDE

wall light; aluminium, steel, white
Wandleuchte; Alu, Stahl, weiss
Applique; aluminium, acier, blanc

L 360, H 80, A 50



12W 1550lm



9 002759 990862



900325 ZUBIALDE

wall light; steel, wood, black, brown
Wandleuchte; Stahl, Holz, schwarz, braun
Applique; acier, bois, noir, marron

L 360, H 80, A 50



12W 1550lm



9 008606 235360





900871

LED



96049

LED



900871

These luminaires can be mounted left or right sideways to the wall. This creates a beautiful grazing light.

Diese Leuchten können links und rechts, seitlich zur Wand montiert werden. Dabei entsteht ein schönes Streiflicht.

Ces luminaires peuvent être montés latéralement à gauche ou à droite du mur. Cela crée une belle lumière rasante.



96048

LED

900871 TUDONS

wall light; aluminium, steel, wood, black, brown
Wandleuchte; Alu, Stahl, Holz, schwarz, braun
Applique; aluminium, acier, bois, noir, marron

L 560, B 60, H 45



1x 12W 1300lm



9 008606 274468



96049 ONO 2

wall light; aluminium, anthracite / plastic, clear
Wandleuchte; Alu, anthrazit / Kunststoff, klar
Applique; aluminium, gris anthracite / plastique, transparent

L 90, H 80, A 130



2x 2,5W 500lm



9 002759 960490



96048 ONO 2

wall light; aluminium, white / plastic, clear
Wandleuchte; Alu, weiss / Kunststoff, klar
Applique; aluminium, blanc / plastique, transparent

L 90, H 80, A 130



2x 2,5W 500lm



9 002759 960483





98542



98541



98543



98541 MACCARI

wall light; aluminium, steel, white / plastic, transparent
Wandleuchte; Alu, Stahl, weiss / Kunststoff, transparent
Applique; aluminium, acier, blanc / plastique, transparent

L 270, H 75, A 130

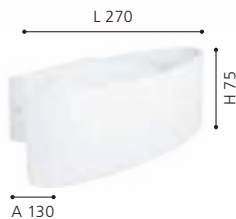

98542 MACCARI

wall light; aluminium, steel, black, gold / plastic, transparent
Wandleuchte; Alu, Stahl, schwarz, gold / Kunststoff, transparent
Applique; aluminium, acier, noir, or / plastique, transparent

L 270, H 75, A 130

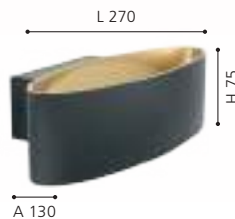

98543 MACCARI

wall light; aluminium, steel, white, satin nickel / plastic, transparent
Wandleuchte; Alu, Stahl, weiss, nickel-matt / Kunststoff, transparent
Applique; aluminium, acier, blanc, nickel mat / plastique, transparent

L 270, H 75, A 130

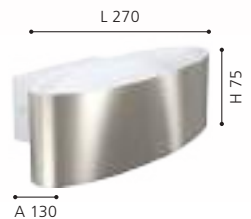



98544



98545



98544 FELONICHE

wall light; aluminium, white / plastic, transparent
 Wandleuchte; Alu, weiss / Kunststoff, transparent
 Applique; aluminium, blanc / plastique, transparent

L 220, H 100, A 75



10W 1300lm



9 002759 985448

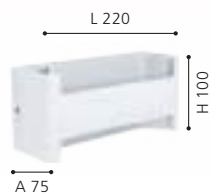

98545 FELONICHE

wall light; aluminium, black, gold / plastic, transparent
 Wandleuchte; Alu, schwarz, gold / Kunststoff, transparent
 Applique; aluminium, noir, or / plastique, transparent

L 220, H 100, A 75



10W 1300lm



9 002759 985455

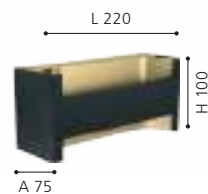



98421



98422



98423



98421 SANIA 4

wall light; aluminium, white
Wandleuchte; Alu, weiss
Applique; aluminium, blanc

L 130, H 80, A 90



6W

670lm



9 002759 984212



98422 SANIA 4

wall light; aluminium, white
Wandleuchte; Alu, weiss
Applique; aluminium, blanc

L 200, H 80, A 90



10W

1300lm



9 002759 984229

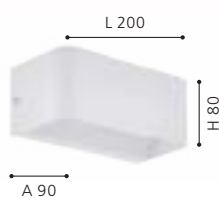

98423 SANIA 4

wall light; aluminium, white
Wandleuchte; Alu, weiss
Applique; aluminium, blanc

L 365, H 80, A 90



12W

1400lm



9 002759 984236

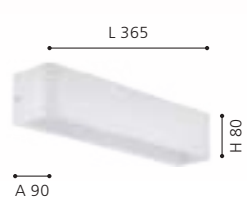



98424



98425



98426



98424 SANIA 4

wall light; aluminium, satin nickel
Wandleuchte; Alu, nickel-matt
Applique; aluminium, nickel mat

L 130, H 80, A 90



6W 670lm



9 002759 984243

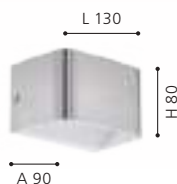

98425 SANIA 4

wall light; aluminium, satin nickel
Wandleuchte; Alu, nickel-matt
Applique; aluminium, nickel mat

L 200, H 80, A 90



10W 1300lm



9 002759 984250

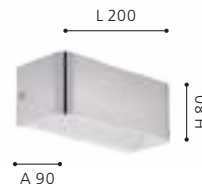

98426 SANIA 4

wall light; aluminium, satin nickel
Wandleuchte; Alu, nickel-matt
Applique; aluminium, nickel mat

L 365, H 80, A 90



12W 1400lm



9 002759 984267



DESIGN
HIGHLIGHT
DETAIL



96261

LED



96264

LED

96261 PASSA

wall light; steel, satin nickel, chrome
Wandleuchte; Stahl, nickel-matt, chrom
Applique; acier, nickel mat, chrome

L 60, H 170, A 85



GU10



2x 3W



warm
WHITE
2x
250lm



9 002759 962616



96264 PASSA

wall light; steel, satin nickel, chrome
Wandleuchte; Stahl, nickel-matt, chrom
Applique; acier, nickel mat, chrome

L 55, H 170, A 85



GU10



2x 3W



warm
WHITE
2x
250lm



9 002759 962647





95368

LED



95377

LED

95368 PASSA

wall light; steel, chrome, white
Wandleuchte; Stahl, chrom, weiss
Applique; acier, chrome, blanc

L 60, H 170, A 85



GU10



2x 3W



2x
warm
WHITE
250lm



9 002759 953683



95377 PASSA

wall light; steel, chrome, white
Wandleuchte; Stahl, chrom, weiss
Applique; acier, chrome, blanc

L 55, H 170, A 85



GU10



2x 3W



2x
warm
WHITE
250lm



9 002759 953775





95371

LED



95379

LED

95371 PASSA

wall light; steel, brown, copper
Wandleuchte; Stahl, braun, kupfer
Applique; acier, marron, cuivre

L 60, H 170, A 85

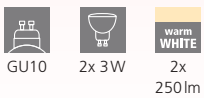

95379 PASSA

wall light; steel, brown, copper
Wandleuchte; Stahl, braun, kupfer
Applique; acier, marron, cuivre

L 55, H 170, A 85

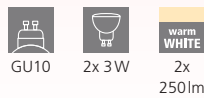

95364 PASSA

wall light; steel, black, gold
Wandleuchte; Stahl, schwarz, gold
Applique; acier, noir, or

L 60, H 170, A 85





95364

LED



95373

LED

95373 PASSA

wall light; steel, black, gold
Wandleuchte; Stahl, schwarz, gold
Applique; acier, noir, or

L 55, H 170, A 85



GU10



2x 3W



warm
WHITE
2x
250lm



9 002759 953737

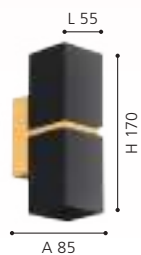



98379



98755



98759

98379 GASCUERIA

wall light; plastic, steel, gold, black
Wandleuchte; Kunststoff, Stahl, gold, schwarz
Applique; plastique, acier, or, noir

L 290, H 330, A 130



E27



1x 60W



L 290



H 330

A 130



9 002759 983796

98755 ELIZONDO

wall light; steel, black, gold
Wandleuchte; Stahl, schwarz, gold
Applique; acier, noir, or

L 80, H 270, A 115



E14



1x 40W

L 80



H 270

A 115



9 002759 987558

98759 FALICETTO

wall light; steel, black, gold
Wandleuchte; Stahl, schwarz, gold
Applique; acier, noir, or

L 160, H 250, A 115



E27



1x 40W

L 160



H 250

A 115



9 002759 987596



900375

900375 HAYES

wall light; steel, black, gold
 Wandleuchte; Stahl, schwarz, gold
 Applique; acier, noir, or

L 120, H 225, A 120



E27



1x 40W



9 008606 240555



900375

The golden element of the luminaires can be rotated. This allows the light to be individually adjusted.

Das goldene Element der Leuchten ist drehbar. Dadurch lässt sich der Lichtschein individuell anpassen.

L'élément doré du luminaires peut être tourné. Cela permet de régler la lumière individuellement.



900343



900518

900343 TANURA

wall light; steel, black
Wandleuchte; Stahl, schwarz
Applique; acier, noir

L 245, H 110, A 105



E27



1x 25W



9 008606 243495

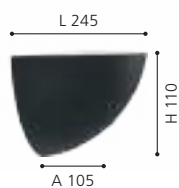

900518 GUANAL

wall light; aluminium, steel, chrome
Wandleuchte; Alu, Stahl, chrom
Applique; aluminium, acier, chrome

L 600, B 50, H 60



E27



4x 40W



9 008606 244478



900517 GUANAL

wall light; aluminium, steel, black
Wandleuchte; Alu, Stahl, schwarz
Applique; aluminium, acier, noir

L 600, B 50, H 60



E27



4x 40W



9 008606 244461





900517



30658



30659



33941



30658 CADEGAL

ceiling light; steel, black / plastic, white
 Deckenleuchte; Stahl, schwarz / Kunststoff, weiss
 plafonnier; acier, noir / plastique, blanc

L 200, B 200, H 50



7,8W 1200lm

30659 CADEGAL

ceiling light; steel, black / plastic, white
 Deckenleuchte; Stahl, schwarz / Kunststoff, weiss
 plafonnier; acier, noir / plastique, blanc

H 50, Ø 200



7,8W 1100lm

33941 CADEGAL

ceiling light; steel, white / plastic, white
 Deckenleuchte; Stahl, weiss / Kunststoff, weiss
 plafonnier; acier, blanc / plastique, blanc

L 200, B 200, H 50



7,8W 1200lm



9 002759 306588

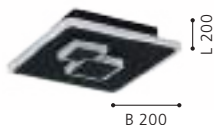

9 002759 306595



9 002759 339418





33942

LED



33964

LED



33942 CADEGAL

ceiling light; steel, white / plastic, white
Deckenleuchte; Stahl, weiss / Kunststoff, weiss
plafonnier; acier, blanc / plastique, blanc

H 50, Ø 200



7,8W 1100lm



33964 REMIDOS

ceiling light; steel, white / plastic, white
Deckenleuchte; Stahl, weiss / Kunststoff, weiss
plafonnier; acier, blanc / plastique, blanc

H 90, Ø 400



15,5W 2200lm 4,5W 600lm





98888



96037



96038



98888 METRASS

wall light; aluminium, black / plastic, satin finish
Wandleuchte; Alu, schwarz / Kunststoff, satiniert
Applique; aluminium, noir / plastique, satiné

L 200, H 105, A 60



1x 5,6W 680lm

96037 METRASS

wall light; aluminium, white / plastic, satin finish
Wandleuchte; Alu, weiss / Kunststoff, satiniert
Applique; aluminium, blanc / plastique, satiné

L 200, H 105, A 60



1x 5,6W 680lm

96038 METRASS

wall light; aluminium, satin nickel / plastic, satin finish
Wandleuchte; Alu, nickel-matt / Kunststoff, satiniert
Applique; aluminium, nickel mat / plastique, satiné

L 200, H 105, A 60



1x 5,6W 680lm



9 002759 988883



9 002759 960377



9 002759 960384





96042



96043



96042 METRASS 2

wall/ceiling light; aluminium, white / plastic, satin finish
Wand- / Deckenleuchte; Alu, weiss / Kunststoff, satiniert
Applique/Plafonnier; aluminium, blanc / plastique, satiné

L 170, H 200, A 55



2x 4,5W 960lm



9 002759 960421

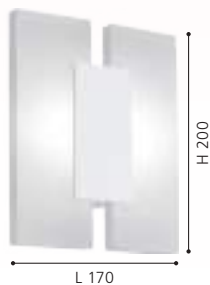

96043 METRASS 2

wall/ceiling light; aluminium, satin nickel / plastic, satin finish
Wand- / Deckenleuchte; Alu, nickel-matt / Kunststoff, satiniert
Applique/Plafonnier; aluminium, nickel mat / plastique, satiné

L 170, H 200, A 55



2x 4,5W 960lm



9 002759 960438





96039





96041



96039 METRASS 1

wall light; aluminium, white / plastic, satin finish
 Wandleuchte; Alu, weiss / Kunststoff, satiniert
 Applique; aluminium, blanc / plastique, satiné

L 130, H 130, A 50



1x 4,5W 480lm



9 002759 960391

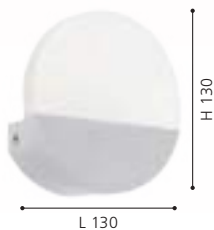

96041 METRASS 1

wall light; aluminium, satin nickel / plastic, satin finish
 Wandleuchte; Alu, nickel-matt / Kunststoff, satiniert
 Applique; aluminium, nickel mat / plastique, satiné

L 130, H 130, A 50



1x 4,5W 480lm



9 002759 960414





99606



99607



99609



99606 SARGINTO

wall/ceiling light; steel, white / plastic, white
Wand- / Deckenleuchte; Stahl, weiss / Kunststoff, weiss
Applique/Plafonnier; acier, blanc / plastique, blanc

L 590, B 140, H 45



9 002759 996062

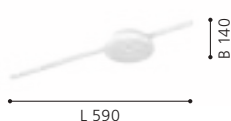

99607 SARGINTO

wall/ceiling light; steel, white / plastic, white
Wand- / Deckenleuchte; Stahl, weiss / Kunststoff, weiss
Applique/Plafonnier; acier, blanc / plastique, blanc

L 590, B 130, H 45



9 002759 996079

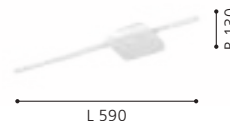

99609 SARGINTO

wall/ceiling light; steel, black / plastic, white
Wand- / Deckenleuchte; Stahl, schwarz / Kunststoff, weiss
Applique/Plafonnier; acier, noir / plastique, blanc

L 590, B 130, H 45



9 002759 996093





99608

LED

99608 SARGINTO

wall/ceiling light; steel, black / plastic, white

Wand- / Deckenleuchte; Stahl, schwarz / Kunststoff, weiss

Applique/Plafonnier; acier, noir / plastique, blanc

L 590, B 140, H 45

LED

6,3W

warm
WHITE

950lm

LED

5,4W

warm
WHITE

570lm



9 002759 996086





BATH & MIRROR LUMINAIRES

BAD- & SPIEGELLEUCHTEN
LUMINAIRES DE BAIN & MIROIR



EN PURE RELAXATION

Turn your bathroom into your personal wellness oasis. Trendy bathroom and mirror luminaires give a pleasant light and ensure relaxation and comfort.

DE ENTSPANNUNG PUR

Verwandeln Sie Ihr Badezimmer in eine persönliche Wohlfühloase. Trendige Bad- und Spiegelleuchten spenden ein angenehmes Licht und sorgen für Entspannung und Ihr Wohlbefinden.

FR DE LA PURE DÉTENTE











































Transformez votre salle de bains en un îlot personnel de bien-être. Des éclairages à la mode de miroirs et de bain confèrent une lumière agréable et vous assurent de la détente et du bien-être.





OVERVIEW

BATH & MIRROR LUMINAIRES
BAD- & SPIEGELLEUCHTEN
LUMINAIRES DE BAIN & MIROIR

 AMEZOLA 620	 SAN PERI 1 621	 TAMARA 1 622-623	 ALMONTE 624	 TOLIRICO 626	 PALMITAL 628-629	 MOSIANO 630	 BARI-M 630	
 FRANIA 631-632	 FRANIA-S 631, 633	 WASAO 1 632	 MANILVA 1 632	 PINETTO 634-635	 LED PALERMO 634-635	 LED CARPI 636-637	 FUEVA 5 638-646	
 ROMENDO 1 648-649	 SIDERNO 650	 SANIA 5 650-651	 PEGUERA 653	 VERDELLO 653-654	 GEMILIANA 654-655	 ALCUDIA 656	 CALNOVA 657	
 TORRETTA 657	 TRAGACETE 1 658-659	 GITA 2 660	 TABIANO 663	 CABUS 663	 VADUMI 664	 PANDELLA 2 666, 670	 PANDELLA 1 666-669	
 VINCHIO 670	 PALMERA 672	 ZOLA 672	 BARI 1 673	 STICKER 673	 BUENAVISTA 674	 BUENAVISTA 1 676	 BUENAVISTA 2 676-677	
 TABIANO-Z 44	 FUEVA-Z 76-87	 TOTARI-Z 88	Bath & mirror lights can also be found in the EGLO connect.Z chapter. Bad- und Spiegelleuchten finden Sie auch im Kapitel EGLO connect.Z. Les luminaires de bain & miroir se trouvent également dans le chapitre EGLO connect.Z.					



This product is available in different colors and shapes. / Dieser Artikel ist in unterschiedlichen Farben und Formen verfügbar. / Cet article est disponible en différentes couleurs et formes.





99122 AMEZOLA

wall/ceiling light; steel, black / glass, clear
 Wand- / Deckenleuchte; Stahl, schwarz / Glas, klar
 Applique/Plafonnier; acier, noir / verre, transparent

L 290, H 290, A 130



99123 AMEZOLA

wall light; steel, black / glass, clear
 Wandleuchte; Stahl, schwarz / Glas, klar
 Applique; acier, noir / verre, transparent

L 110, H 260, A 100



99124 AMEZOLA

wall light; steel, black / glass, clear
 Wandleuchte; Stahl, schwarz / Glas, klar
 Applique; acier, noir / verre, transparent

L 110, H 380, A 100

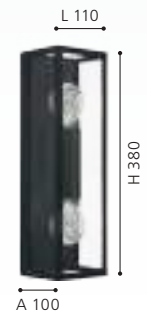
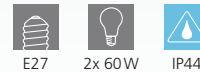



99124



IP44



900428

LED



IP44

900428 SAN PERI 1

wall light; steel, black, white
Wandleuchte; Stahl, schwarz, weiss
Applique; acier, noir, blanc

L 130, H 180, A 160



GU10



1x 3W



warm
WHITE
1x
240lm



IP44



9 008606 243877





95994



IP44



95993



IP44



95995



IP44

95993 TAMARA 1

spot; steel, glass, white, chrome
Spot; Stahl, Glas, weiss, chrom
spot; acier, verre, blanc, chrome

L 120, B 120



GU10



1x 3W



warm
WHITE

1x

240lm



IP44



95994 TAMARA 1

spot; steel, glass, white, chrome
Spot; Stahl, Glas, weiss, chrom
spot; acier, verre, blanc, chrome

L 460, B 70



GU10



3x 3W



warm
WHITE

3x

240lm



IP44



95995 TAMARA 1

spot; steel, glass, white, chrome
Spot; Stahl, Glas, weiss, chrom
spot; acier, verre, blanc, chrome

L 240, B 260



GU10



4x 3W



warm
WHITE

4x

240lm



IP44



9 002759 959937



L 120

B 120



9 002759 959944



L 460

B 70



9 002759 959951



L 240

B 260



33677

LED



IP44



33678

LED



IP44

33677 TAMARA 1

spot; steel, black, chrome / glass, clear
 Spot; Stahl, schwarz, chrom / Glas, klar
 spot; acier, noir, chrome / verre, transparent

L 120, B 120



GU10



1x 3W



1x
warm
WHITE
240lm



IP44



33678 TAMARA 1

spot; steel, black, chrome / glass, clear
 Spot; Stahl, schwarz, chrom / Glas, klar
 spot; acier, noir, chrome / verre, transparent

L 240, B 260



GU10



4x 3W



4x
warm
WHITE
240lm



IP44



9 002759 336776



L 120

B 120



9 002759 336783



L 240

B 260

DESIGN
HIGHLIGHT
DETAIL



94879

LED



IP44



97699

LED



IP44

94879 ALMONTE

wall light; steel, chrome / brilliant glass, clear
Wandleuchte; Stahl, chrom / Brillantglas, klar
Applique; acier, chrome / verre brillant, transparent

L 110, H 230, A 170



G9



1x 3W



1x
320lm



IP44



97699 ALMONTE

ceiling light; steel, chrome / brilliant glass, clear
Deckenleuchte; Stahl, chrom / Brillantglas, klar
plafonnier; acier, chrome / verre brillant, transparent

H 300, Ø 500



G9



8x 3W



8x
320lm



IP44



94878 ALMONTE

ceiling light; steel, chrome / brilliant glass, clear
Deckenleuchte; Stahl, chrom / Brillantglas, klar
plafonnier; acier, chrome / verre brillant, transparent

H 230, Ø 350



G9



4x 3W



4x
320lm



IP44



9 002759 948795



9 002759 976996

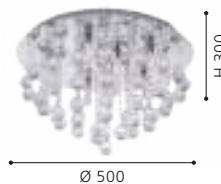

9 002759 948788





94878

LED



IP44





TOLORICO

These luminaires come with high quality brilliant glass.

Diese Leuchten sind mit hochwertigem Brillantglas ausgestattet.

Ces lumières sont fabriquées avec une haute qualité Equipé de verre brillant.



97054

LED



IP44



97055

LED



IP44

97054 TOLORICO

wall/ceiling light; stainless steel, chrome / plastic, brilliant glass, clear

Wand- / Deckenleuchte; Edelstahl, chrom / Kunststoff, Brillantglas, klar

Applique/Plafonnier; acier inoxydable, chrome / plastique, verre brillant, transparent
L 350, B 100, H 70

LED

8W

neutral
WHITE

1000lm



IP44



97055 TOLORICO

wall/ceiling light; stainless steel, chrome / plastic, brilliant glass, clear

Wand- / Deckenleuchte; Edelstahl, chrom / Kunststoff, Brillantglas, klar

Applique/Plafonnier; acier inoxydable, chrome / plastique, verre brillant, transparent
L 570, B 100, H 75

LED

20,5W

neutral
WHITE

2700lm



IP44



97056 TOLORICO

wall/ceiling light; stainless steel, chrome / plastic, brilliant glass, clear

Wand- / Deckenleuchte; Edelstahl, chrom / Kunststoff, Brillantglas, klar

Applique/Plafonnier; acier inoxydable, chrome / plastique, verre brillant, transparent
L 350, B 350, H 75

LED

22W

neutral
WHITE

3000lm



IP44



9 002759 970543



9 002759 970550



9 002759 970567





97056

LED



IP44





97965



IP44

97965 PALMITAL

wall/ceiling light; aluminium, steel, chrome / plastic, clear
Wand- / Deckenleuchte; Alu, Stahl, chrom / Kunststoff, klar
Applique/Plafonnier; aluminium, acier, chrome / plastique,
transparent

L 880, B 100, H 90



2x 11 W



2700lm



IP44



9 002759 979652

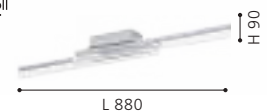



900844



IP44



97966



IP44



900845



IP44

900844 PALMITAL

wall/ceiling light; aluminium, steel, black / plastic, satin finish
Wand- / Deckenleuchte; Alu, Stahl, schwarz / Kunststoff, satiniert
Applique/Plafonnier; aluminium, acier, noir / plastique, satiné

L 880, B 100, H 90



2x 11 W 2700lm

97966 PALMITAL

wall light; aluminium, steel, chrome / plastic, clear
Wandleuchte; Alu, Stahl, chrom / Kunststoff, klar
Applique; aluminium, acier, chrome / plastique, transparent

L 595, H 80, A 65



1x 11 W 1350lm

900845 PALMITAL

wall light; aluminium, steel, black / plastic, satin finish
Wandleuchte; Alu, Stahl, schwarz / Kunststoff, satiniert
Applique; aluminium, acier, noir / plastique, satiné

L 595, H 80, A 65



1x 11 W 1350lm



9 008606 259762



L 880



9 002759 979669



L 595



9 008606 259779



L 595



94626

LED



IP44



97531



97531



IP44

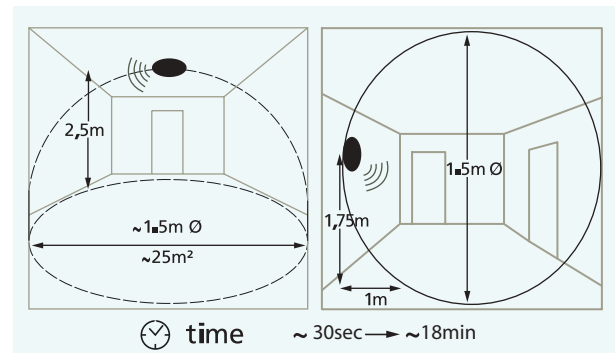

97531

These luminaires are equipped with an integrated motion sensor. The sensor is invisibly mounted behind the glass.

Diese Leuchten sind mit einem integrierten Bewegungssensor ausgestattet. Der Sensor ist unsichtbar hinter dem Glas befestigt.

Ces luminaires sont équipés d'un capteur de mouvement intégré. Le capteur est fixé de manière invisible derrière le verre.

94626 MOSIANO

wall/ceiling light; stainless steel, chrome / matte-opal glass, white

Wand- / Deckenleuchte; Edelstahl, chrom / Glas opal-matt, weiss

Applique/Plafonnier; acier inoxydable, chrome / verre opale mat, blanc

H 115, Ø 110



1x 3,3W



340 lm



IP44



97531 BARI-M

ceiling light; plastic, white / glass, white

Deckenleuchte; Kunststoff, weiss / Glas, weiss

plafonnier; plastique, blanc / verre, blanc

H 110, Ø 275



E27



1x 20W



IP44



9 002759 946265



9 002759 975319





97884



IP44



900363



IP44



900619



IP44

97884 FRANIA

wall/ceiling light; steel, white / plastic, white
Wand- / Deckenleuchte; Stahl, weiss / Kunststoff, weiss
Applique/Plafonnier; acier, blanc / plastique, blanc

H 70, Ø 330



14,6W



1600lm



IP44

900363 FRANIA-S

wall/ceiling light; steel, white / plastic with crystal effect, white
Wand- / Deckenleuchte; Stahl, weiss / Kunststoff m.Kristalleffekt, weiss
Applique/Plafonnier; acier, blanc / plastique avec effet cristal, blanc

H 55, Ø 310



18W



1850lm



IP44

900619 FRANIA-S

wall/ceiling light; steel, white / plastic with crystal effect, white
Wand- / Deckenleuchte; Stahl, weiss / Kunststoff m.Kristalleffekt, weiss
Applique/Plafonnier; acier, blanc / plastique avec effet cristal, blanc

H 55, Ø 310



15W



1800lm



IP44



9 002759 978846



9 008606 234455



9 008606 245161





94884



IP44



96229



IP44

94884 WASAO 1

wall/ceiling light; stainless steel, chrome / painted glass, white
Wand- / Deckenleuchte; Edelstahl, chrom / Glas lackiert, weiss
Applique/Plafonnier; acier inoxydable, chrome / verre laqué, blanc

L 320, B 320, H 60



4x 5,4W 2040lm

96229 MANILVA 1

wall light; steel, chrome / plastic, white
Wandleuchte; Stahl, chrom / Kunststoff, weiss
Applique; acier, chrome / plastique, blanc

L 290, B 290, H 70



2x 5,4W 1100lm 2x 2,6W 660lm



IP44

97885 FRANIA

wall/ceiling light; steel, white / plastic, white
Wand- / Deckenleuchte; Stahl, weiss / Kunststoff, weiss
Applique/Plafonnier; acier, blanc / plastique, blanc

L 330, B 330, H 70



14,6W 1600lm



9 002759 948849

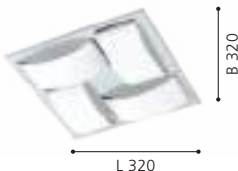

L 320



9 002759 962296

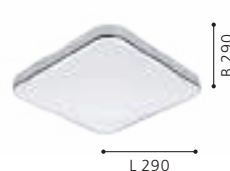

L 290



9 002759 978853



L 330



97885



900364



900364 FRANIA-S

wall/ceiling light; steel, white / plastic with crystal effect, white
Wand- / Deckenleuchte; Stahl, weiss / Kunststoff m.Kristalleffekt, weiss
Applique/Plafonnier; acier, blanc / plastique avec effet cristal, blanc

L 330, B 330, H 70



9 008606 234462





900846



IP44



900366



IP44

900366 PINETTO

wall/ceiling light; steel, white / plastic, white, black
Wand- / Deckenleuchte; Stahl, weiss / Kunststoff, weiss, schwarz
Applique/Plafonnier; acier, blanc / plastique, blanc, noir

H 65, Ø 340



15,6W



1900lm



IP44

900846 LED PALERMO

wall/ceiling light; steel, black / satin glass, white painted
Wand- / Deckenleuchte; Stahl, schwarz / Glas satiniert, weiss lackiert
Applique/Plafonnier; acier, noir / verre satiné, blanc laqué

H 75, Ø 300



3x 5,7W



2100lm



IP44

DESIGN
HIGHLIGHT
DETAIL



9 008606 235971



9 008606 259786

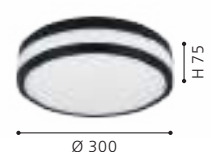



94999



IP44



900365



IP44



94998



IP44

900365 PINETTO

wall/ceiling light; steel, white / plastic, white, chrome
Wand- / Deckenleuchte; Stahl, weiss / Kunststoff, weiss, chrom
Applique/Plafonnier; acier, blanc / plastique, blanc, chrome

H 65, Ø 340



15,6W 1900lm

94998 LED PALERMO

wall/ceiling light; steel, chrome / satin glass, white painted
Wand- / Deckenleuchte; Stahl, chrom / Glas satiniert, weiss lackiert
Applique/Plafonnier; acier, chrome / verre satiné, blanc laqué

H 60, Ø 225



3x 3,6W 1110lm

94999 LED PALERMO

wall/ceiling light; steel, chrome / satin glass, white painted
Wand- / Deckenleuchte; Stahl, chrom / Glas satiniert, weiss lackiert
Applique/Plafonnier; acier, chrome / verre satiné, blanc laqué

H 75, Ø 300



3x 5,7W 2100lm



9 008606 235964



9 002759 949983



9 002759 949990





33682



IP44



95282



IP44



900369



IP44

33682 LED CARPI

wall/ceiling light; steel, black, white / plastic, white
Wand- / Deckenleuchte; Stahl, schwarz, weiss / Kunststoff, weiss
Applique/Plafonnier; acier, noir, blanc / plastique, blanc

Ø 300, A 75



3x 3,6W

960lm

IP44

900369 LED CARPI

ceiling light; steel, brushed brass, white / plastic, white
Deckenleuchte; Stahl, messing-gebürstet, weiss / Kunststoff, weiss
plafonnier; acier, laiton brossé, blanc / plastique, blanc

Ø 300, A 75



3x 3,6W

1110lm

IP44

95282 LED CARPI

wall/ceiling light; steel, white, chrome / plastic, white
Wand- / Deckenleuchte; Stahl, weiss, chrom / Kunststoff, weiss
Applique/Plafonnier; acier, blanc, chrome / plastique, blanc

Ø 300, A 75



3x 3,6W

960lm

IP44



9 002759 336820



Ø 300



9 008606 240623



Ø 300



9 002759 952822



Ø 300



95283

LED



IP44



95283 LED CARPI

wall/ceiling light; steel, white, chrome / plastic, white
Wand- / Deckenleuchte; Stahl, weiss, chrom / Kunststoff, weiss
Applique/Plafonnier; acier, blanc, chrome / plastique, blanc

Ø 385, A 75

LED

warm
WHITE



3x 7,3 W

2220 lm

IP44



Ø 385

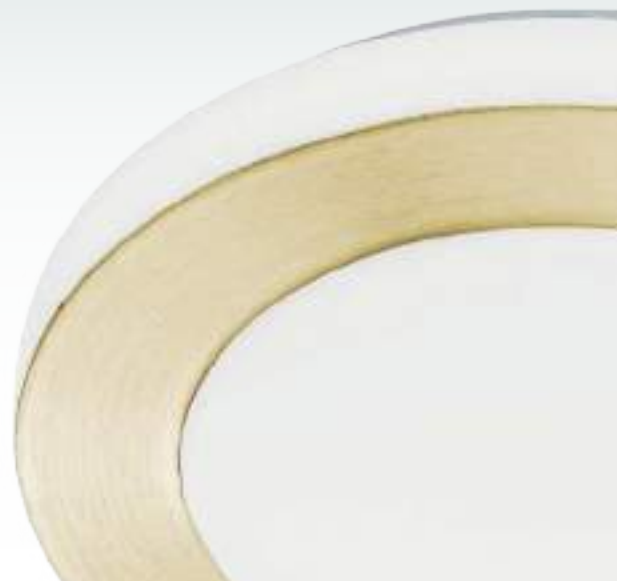

FUEVA 5

These luminaires are protected against splash water.

Diese Leuchten sind gegen Spritzwasser geschützt.

Les luminaires sont protégées contre les éclaboussures d'eau.



IP44

	0	1	2	3
EU	X	X	✓	✓
FR	X	X	X	✓



99202



IP44

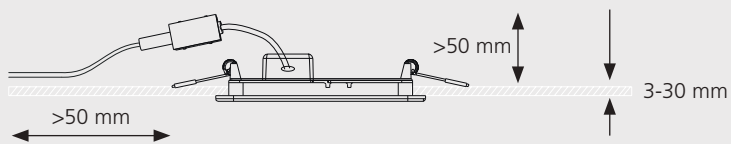

FUEVA 5

Slim design and minimal installation depth. This makes it ideal for ceiling constructions with little space. Easy installation / replacement of the lights with practical connectors.

Schlanke Bauform und minimale Einbautiefe. Dadurch ideal für Deckenkonstruktionen mit wenig Platz. Einfache Montage / Austausch der Leuchten durch praktischen Verbinder.

Conception mince et profondeur d'installation minimale. Cela le rend idéal pour les constructions de plafond avec peu d'espace. Installation / remplacement facile des lumières avec des connecteurs pratiques.

99202 FUEVA 5

recessed light; steel, white / plastic, white
Einbauleuchte; Stahl, weiss / Kunststoff, weiss
luminaire encastrable; acier, blanc / plastique, blanc

Ø 86, ET 26



2,7W



330lm



Ø 75



IP44



9 002759 992026



Ø 86

99203 FUEVA 5

recessed light; steel, white / plastic, white
Einbauleuchte; Stahl, weiss / Kunststoff, weiss
luminaire encastrable; acier, blanc / plastique, blanc

Ø 166, ET 26



11W



1350lm



Ø 155



IP44



9 002759 992033



Ø 166

99206 FUEVA 5

recessed light; steel, white / plastic, white
Einbauleuchte; Stahl, weiss / Kunststoff, weiss
luminaire encastrable; acier, blanc / plastique, blanc

Ø 86, ET 26



2,7W



330lm



Ø 75



IP44



9 002759 992064



Ø 86



99203

LED



IP44



99206

LED



IP44

99207 FUEVA 5

recessed light; steel, white / plastic, white
Einbauleuchte; Stahl, weiss / Kunststoff, weiss
luminaire encastrable; acier, blanc / plastique, blanc

Ø 166, ET 26

LED

11W

neutral
WHITE

1350lm



Ø 155



IP44



9 002759 992071



Ø 166



99207

LED



IP44

FUEVA 5

These luminaires are protected against splash water.

Diese Leuchten sind gegen Spritzwasser geschützt.

Les luminaires sont protégées contre les éclaboussures d'eau.



IP44

	0	1	2	3
EU	X	X	✓	✓
FR	X	X	X	✓



99208



IP44



99209



IP44

FUEVA 5

Slim design and minimal installation depth. This makes it ideal for ceiling constructions with little space. Easy installation / replacement of the lights with practical connectors.

Schlanke Bauform und minimale Einbautiefe. Dadurch ideal für Deckenkonstruktionen mit wenig Platz. Einfache Montage / Austausch der Leuchten durch praktischen Verbinder.

Conception mince et profondeur d'installation minimale. Cela le rend idéal pour les constructions de plafond avec peu d'espace. Installation / remplacement facile des lumières avec des connecteurs pratiques.

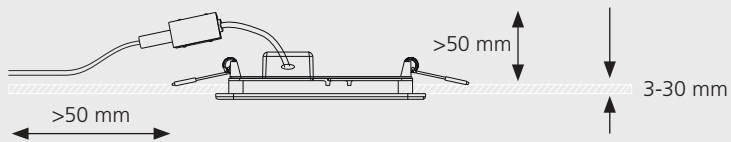

99208 FUEVA 5

recessed light; steel, chrome / plastic, white
Einbauleuchte; Stahl, chrom / Kunststoff, weiss
luminaire encastrable; acier, chrome / plastique, blanc

Ø 86, ET 26



2,7W



330lm



Ø 75



IP44



9 002759 992088



Ø 86

99209 FUEVA 5

recessed light; steel, chrome / plastic, white
Einbauleuchte; Stahl, chrom / Kunststoff, weiss
luminaire encastrable; acier, chrome / plastique, blanc

Ø 166, ET 26



11W



1350lm



Ø 155



IP44



9 002759 992095



Ø 166

99205 FUEVA 5

recessed light; steel, chrome / plastic, white
Einbauleuchte; Stahl, chrom / Kunststoff, weiss
luminaire encastrable; acier, chrome / plastique, blanc

Ø 166, ET 26



11W



1350lm



Ø 155



IP44



9 002759 992057



Ø 166



99205



IP44



99204



IP44

99204 FUEVA 5

recessed light; steel, chrome / plastic, white
Einbauleuchte; Stahl, chrom / Kunststoff, weiss
luminaire encastrable; acier, chrome / plastique, blanc

Ø 86, ET 26



2,7W



330lm



Ø 75



IP44



9 002759 992040



Ø 86

FUEVA 5

These luminaires are protected against splash water.

Diese Leuchten sind gegen Spritzwasser geschützt.

Les luminaires sont protégées contre les éclaboussures d'eau.



IP44

	0	1	2	3
EU	X	X	✓	✓
FR	X	X	X	✓



99213



IP44



99214



IP44

FUEVA 5

Slim design and minimal installation depth. This makes it ideal for ceiling constructions with little space. Easy installation / replacement of the lights with practical connectors.

Schlanke Bauform und minimale Einbautiefe. Dadurch ideal für Deckenkonstruktionen mit wenig Platz. Einfache Montage / Austausch der Leuchten durch praktischen Verbinder.

Conception mince et profondeur d'installation minimale. Cela rend idéal pour les constructions de plafond avec peu d'espace. Installation / remplacement facile des lumières avec des connecteurs pratiques.

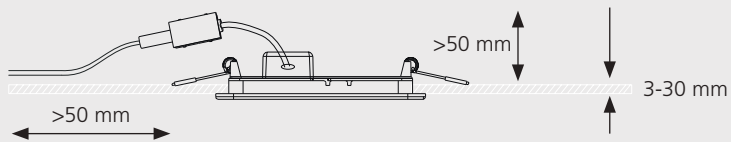

99213 FUEVA 5

recessed light; steel, black / plastic, white
Einbauleuchte; Stahl, schwarz / Kunststoff, weiss
luminaire encastrable; acier, noir / plastique, blanc

Ø 86, ET 26



2,7W



330lm



Ø 75



IP44



9 002759 992132



Ø 86

99214 FUEVA 5

recessed light; steel, black / plastic, white
Einbauleuchte; Stahl, schwarz / Kunststoff, weiss
luminaire encastrable; acier, noir / plastique, blanc

Ø 166, ET 26



11W



1350lm



Ø 155



IP44



9 002759 992149



Ø 166

99212 FUEVA 5

recessed light; steel, black / plastic, white
Einbauleuchte; Stahl, schwarz / Kunststoff, weiss
luminaire encastrable; acier, noir / plastique, blanc

Ø 166, ET 26



11W



1350lm



Ø 155



IP44



9 002759 992125



Ø 166



99212

LED



IP44



99211

LED



IP44

99211 FUEVA 5

recessed light; steel, black / plastic, white
Einbauleuchte; Stahl, schwarz / Kunststoff, weiss
luminaire encastrable; acier, noir / plastique, blanc

Ø 86, ET 26

LED

2,7W

warm
WHITE

330lm



Ø 75



IP44



Ø 86



99265



IP44



99267



IP44

99265 FUEVA 5

surface-mounted light; steel, white / plastic, white
 Aufbauleuchte; Stahl, weiss / Kunststoff, weiss
 luminaire en saillie; acier, blanc / plastique, blanc

H 28, Ø 285



20,5W 2400lm

99267 FUEVA 5

surface-mounted light; steel, black / plastic, white
 Aufbauleuchte; Stahl, schwarz / Kunststoff, weiss
 luminaire en saillie; acier, noir / plastique, blanc

H 28, Ø 285



20,5W 2400lm

99266 FUEVA 5

surface-mounted light; steel, chrome / plastic, white
 Aufbauleuchte; Stahl, chrom / Kunststoff, weiss
 luminaire en saillie; acier, chrome / plastique, blanc

H 28, Ø 285



20,5W 2400lm



9 002759 992651



9 002759 992675



9 002759 992668





99266

LED



IP44





99268



IP44



99271



IP44

99268 FUEVA 5

surface-mounted light; steel, white / plastic, white
 Aufbauleuchte; Stahl, weiss / Kunststoff, weiss
 luminaire en saillie; acier, blanc / plastique, blanc

L 285, B 285, H 30



20,5W 2400lm

99271 FUEVA 5

surface-mounted light; steel, black / plastic, white
 Aufbauleuchte; Stahl, schwarz / Kunststoff, weiss
 luminaire en saillie; acier, noir / plastique, blanc

L 285, B 285, H 30



20,5W 2400lm

99269 FUEVA 5

surface-mounted light; steel, chrome / plastic, white
 Aufbauleuchte; Stahl, chrom / Kunststoff, weiss
 luminaire en saillie; acier, chrome / plastique, blanc

L 285, B 285, H 30



20,5W 2400lm



9 002759 992682

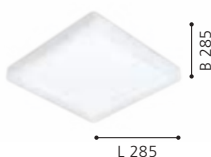

9 002759 992712



9 002759 992699

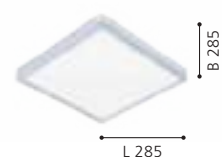



99269

LED



IP44





96541



IP44



96542



IP44



96544



IP44

96541 ROMENDO 1

wall light; steel, chrome / plastic, clear, satin finish
Wandleuchte; Stahl, chrom / Kunststoff, klar, satiniert
Applique; acier, chrome / plastique, transparent, satiné

L 70, H 155, A 120

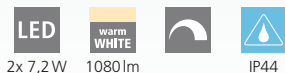

2x 7,2W 1080lm

96542 ROMENDO 1

wall light; steel, chrome / plastic, clear, satin finish
Wandleuchte; Stahl, chrom / Kunststoff, klar, satiniert
Applique; acier, chrome / plastique, transparent, satiné

L 300, H 70, A 125



2x 7,2W 1080lm

96544 ROMENDO 1

ceiling light; steel, chrome / plastic, clear, satin finish
Deckenleuchte; Stahl, chrom / Kunststoff, klar, satiniert
plafonnier; acier, chrome / plastique, transparent, satiné

L 320, B 320, H 70



5x 5,4W 3750lm



9 002759 965419

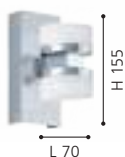

L 70

H 155



9 002759 965426



L 300

H 70



9 002759 965440



L 320

B 320



ROMENDO 1

These luminaires are dimmable.

Diese Leuchten sind dimmbar.

Ces luminaires sont graduables.

96543 ROMENDO 1

wall light; steel, chrome / plastic, clear, satin finish
Wandleuchte; Stahl, chrom / Kunststoff, klar, satiniert
Applique; acier, chrome / plastique, transparent, satiné

L 450, H 70, A 125

LED

3x 7,2W

warm
WHITE

3x
570lm



IP44



96543

LED



IP44



97718



IP44



97719



IP44



99692



IP44

97718 SIDERNO

mirror light; steel, chrome / plastic, satin finish
Spiegelleuchte; Stahl, chrom / Kunststoff, satiniert
applique pour miroir; acier, chrome / plastique, satiné

L 350, B 60, A 55



8,3W



1000lm



IP44



97719 SIDERNO

mirror light; steel, chrome / plastic, satin finish
Spiegelleuchte; Stahl, chrom / Kunststoff, satiniert
applique pour miroir; acier, chrome / plastique, satiné

L 580, B 60, A 65



16W



1600lm



IP44



99692 SANIA 5

wall light; steel, satin nickel, white / plastic, satin finish
Wandleuchte; Stahl, nickel-matt, weiss / Kunststoff, satiniert
Applique; acier, nickel mat, blanc / plastique, satiné

L 620, H 80, A 90



26,5W



3200lm



IP44



9 002759 977184

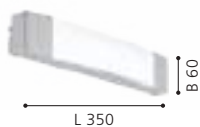

L 350

B 60



9 002759 977191

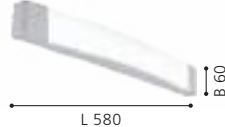

L 580

B 60



9 002759 996925

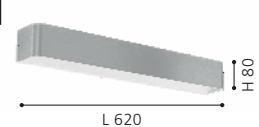

L 620

H 80



99691

LED



IP44

99691 SANIA 5

wall light; steel, black, white / plastic, satin finish
Wandleuchte; Stahl, schwarz, weiss / Kunststoff, satiniert
Applique; acier, noir, blanc / plastique, satiné

L 620, H 80, A 90

LED

26,5W

warm
WHITE

3200lm



IP44



9 002759 996918





900929

LED



IP44



900928



IP44



900475



IP44

900929 PEGUERA

wall light; aluminium, steel, black, brushed brass / plastic, white
Wandleuchte; Alu, Stahl, schwarz, messing-gebürstet / Kunststoff, weiss
Applique; aluminium, acier, noir, laiton brossé / plastique, blanc

L 800, H 110, A 70



17,5W 2000lm



9 008606 274994

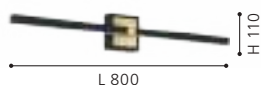

900928 PEGUERA

wall light; aluminium, steel, black, brushed brass / plastic, white
Wandleuchte; Alu, Stahl, schwarz, messing-gebürstet / Kunststoff, weiss
Applique; aluminium, acier, noir, laiton brossé / plastique, blanc

L 600, H 110, A 70



1x 11W 1165lm



9 008606 274987



900475 VERDELLO

mirror light; plastic, black, brass / plastic, white
Spiegelleuchte; Kunststoff, schwarz, messing / Kunststoff, weiss
applique pour miroir; plastique, noir, laiton / plastique, blanc

L 600, B 60, H 105



5W 750lm



9 008606 244126

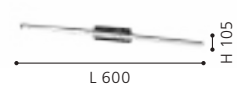

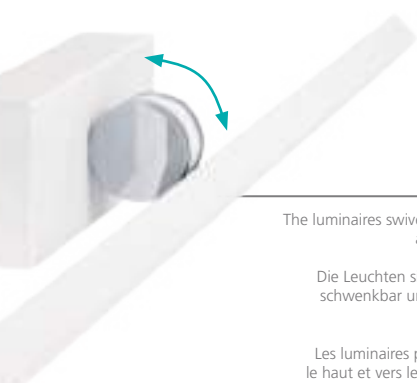

VERDELLO

The luminaires swivel up and down and have a CCT switch on the side.

Die Leuchten sind nach oben und unten schwenkbar und haben einen seitlichen CCT-Schalter.

Les luminaires peuvent être orientés vers le haut et vers le bas et sont équipés d'un interrupteur CCT latéral.



900476



IP44



900616



IP44

900476 VERDELLO

mirror light; plastic, white, chrome / plastic, white
Spiegelleuchte; Kunststoff, weiss, chrom / Kunststoff, weiss
applique pour miroir; plastique, blanc, chrome / plastique, blanc

L 600, B 60, H 105



5W



750lm



IP44



9 008606 244133



900616 GEMILIANA

mirror light; steel, chrome / plastic, white
Spiegelleuchte; Stahl, chrom / Kunststoff, weiss
applique pour miroir; acier, chrome / plastique, blanc

L 450, H 40, A 100



8,9W



1000lm



IP44



9 008606 245130





GEMILIANA

The LED profiles of these luminaires can be swivelled for direct or indirect light.

Die LED-Profil dieser Leuchten sind schwenkbar für direktes oder indirektes Licht.

Les profilés LED de ces luminaires sont orientables pour un éclairage direct ou indirect.

900615 GEMILIANA

mirror light; steel, black / plastic, white
Spiegelleuchte; Stahl, schwarz / Kunststoff, weiss
applique pour miroir; acier, noir / plastique, blanc

L 450, H 40, A 100



8,9W

1000lm

IP44



9 008606 245123



900615

LED



IP44





900618

LED



IP44



900617

LED



IP44

900618 ALCUDIA

mirror light; aluminium, steel, chrome / plastic, satin finish
Spiegelleuchte; Alu, Stahl, chrom / Kunststoff, satiniert
applique pour miroir; aluminium, acier, chrome / plastique, satiné

L 420, H 30, A 60

LED

2x 5,5W

warm
WHITE

1200lm



IP44



900617 ALCUDIA

mirror light; aluminium, steel, black / plastic, satin finish
Spiegelleuchte; Alu, Stahl, schwarz / Kunststoff, satiniert
applique pour miroir; aluminium, acier, noir / plastique, satiné

L 420, H 30, A 60

LED

2x 5,5W

warm
WHITE

1200lm



IP44



9 008606 245154



9 008606 245147



COLOUR RENDERING INDEX FARBWIEDERGABE-INDEX L'INDICE DE RESTITUTION DE COULEURS

The colour rendering index Ra describes the colour rendering quality of lamps. The higher the Ra value, the less will the artificial light change the colour of an object. The maximum Ra value (e.g. the Ra value of the sun) is 100. Therefore, lamps with an Ra above 90 will make you look more natural.

CRI >90 This button indicates Lamps that have an Ra value of >90.

Mit dem Farbwiedergabe-Index Ra wird die Qualität der Farbwiedergabe von Leuchten beschrieben. Je höher der Ra-Wert ist, desto weniger verfälscht das künstliche Licht die Farbe von Objekten. Der maximale Ra-Wert (z.B. der Ra-Wert der Sonne) ist 100. Leuchten mit Ra >90 lassen Sie somit natürlicher aussehen.

CRI >90 Dieser Button kennzeichnet Leuchten die einen Ra-Wert von >90 haben.

L'indice de restitution de couleurs Ra décrit la qualité de restitution des éclairages. Plus la valeur Ra est élevée, moins la lumière artificielle falsifie la couleur des objets. La valeur Ra maximale (par ex. la valeur Ra du soleil) est 100.

CRI >90 Ce bouton signale les luminaires qui ont une valeur Ra >90.

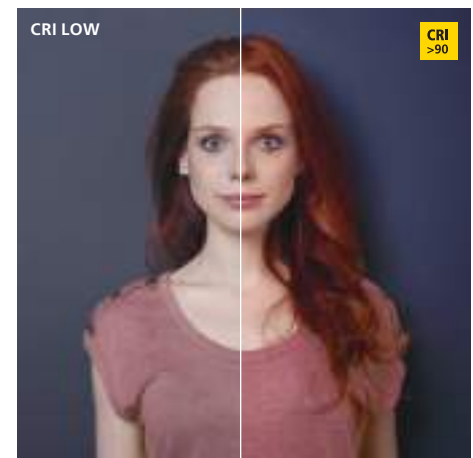

94716 CALNOVA

wall light; steel, satin nickel / satin glass, white
Wandleuchte; Stahl, nickel-matt / Glas satiniert, weiss
Applique; acier, nickel mat / verre satiné, blanc

L 600, B 50, A 85



CRI >90



94617 TORRETTA

mirror light; steel, satin nickel / plastic, white
Spiegelleuchte; Stahl, nickel-matt / Kunststoff, weiss
applique pour miroir; acier, nickel mat / plastique, blanc

L 600, B 40, A 75



CRI >90



TRAGACETE 1

These luminaires refer to an on / off button directly on the luminaire.

Diese Leuchten verfügen über einen Ein-/Ausschaltknopf direkt an der Leuchte.

Ces luminaires se réfèrent à un bouton marche / arrêt directement sur le luminaire.



99776



IP44



99777



IP44



99778



IP44

99776 TRAGACETE 1

mirror light; plastic, steel, silver, chrome / plastic, white
Spiegelleuchte; Kunststoff, Stahl, silber, chrom / Kunststoff, weiss
applique pour miroir; plastique, acier, argent, chrome / plastique, blanc

L 450, B 45, H 45



7,5W



900lm



IP44



9 002759 997762



B 45

99777 TRAGACETE 1

mirror light; plastic, steel, silver, chrome / plastic, white
Spiegelleuchte; Kunststoff, Stahl, silber, chrom / Kunststoff, weiss
applique pour miroir; plastique, acier, argent, chrome / plastique, blanc

L 600, B 45, H 45



15,5W



1900lm



IP44



9 002759 997779



B 45

99778 TRAGACETE 1

mirror light; plastic, steel, silver, chrome / plastic, white
Spiegelleuchte; Kunststoff, Stahl, silber, chrom / Kunststoff, weiss
applique pour miroir; plastique, acier, argent, chrome / plastique, blanc

L 770, B 45, H 45



18,5W



2600lm



IP44



9 002759 997786



B 45



99339

LED



IP44

99339 TRAGACETE 1

mirror light; aluminium, silver, chrome / plastic, white
 Spiegelleuchte; Alu, silber, chrom / Kunststoff, weiss
 applique pour miroir; aluminium, argent, chrome / plastique,
 blanc

L 680, B 55, H 70

LED

15W

neutral
WHITE

1850lm



IP44



99339

These luminaires have a built-in socket.

Diese Leuchten verfügen über eine eingebaute Steckdose.

Ces luminaires disposent d'une prise de courant intégrée.



9 002759 993399





DESIGN
HIGHLIGHT
DETAIL



94712



IP44



94713



IP44

94712 GITA 2

wall/ceiling light; cast metal, chrome / plastic, white
Wand- / Deckenleuchte; Metallguss, chrom / Kunststoff, weiss
Applique/Plafonnier; fonte métallique, chrome / plastique, blanc

L 350, B 75, H 75



8,3W



1000lm



IP44



9 002759 947125



B 75

94713 GITA 2

wall/ceiling light; cast metal, chrome / plastic, white
Wand- / Deckenleuchte; Metallguss, chrom / Kunststoff, weiss
Applique/Plafonnier; fonte métallique, chrome / plastique, blanc

L 600, B 75, H 75



16W



1900lm



IP44



9 002759 947132

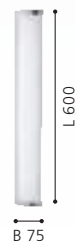

B 75

94714 GITA 2

wall/ceiling light; cast metal, chrome / plastic, white
Wand- / Deckenleuchte; Metallguss, chrom / Kunststoff, weiss
Applique/Plafonnier; fonte métallique, chrome / plastique, blanc

L 900, B 75, H 75



8,3W



850lm



16W



1600lm



IP44



9 002759 947149



B 75



94714

LED



IP44



94613

LED





94612



96937



IP44

94613 TABIANO

mirror light; steel, chrome / plastic, white
Spiegelleuchte; Stahl, chrom / Kunststoff, weiss
applique pour miroir; acier, chrome / plastique, blanc

L 605, H 70, A 130



3x 3,2W 900lm

94612 TABIANO

mirror light; steel, chrome / plastic, white
Spiegelleuchte; Stahl, chrom / Kunststoff, weiss
applique pour miroir; acier, chrome / plastique, blanc

L 405, H 70, A 130



2x 3,2W 600lm

96937 CABUS

wall light; steel, chrome / plastic, satin finish
Wandleuchte; Stahl, chrom / Kunststoff, satiniert
Applique; acier, chrome / plastique, satiné

L 450, H 45, A 115



3x 4,5W 1350lm



9 002759 946135

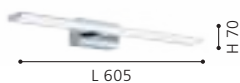

9 002759 946128



9 002759 969370



DESIGN
HIGHLIGHT
DETAIL



97081



IP44



97082



IP44

97081 VADUMI

wall light; plastic, chrome / plastic, white
Wandleuchte; Kunststoff, chrom / Kunststoff, weiss
Applique; plastique, chrome / plastique, blanc

L 400, H 50, A 125



7,4W



900lm



IP44



97082 VADUMI

wall light; plastic, chrome / plastic, white
Wandleuchte; Kunststoff, chrom / Kunststoff, weiss
Applique; plastique, chrome / plastique, blanc

L 600, H 50, A 125



11W



1350lm



IP44



97083 VADUMI

wall light; plastic, chrome / plastic, white
Wandleuchte; Kunststoff, chrom / Kunststoff, weiss
Applique; plastique, chrome / plastique, blanc

L 780, H 50, A 125



14W



1700lm



IP44



9 002759 970819



L 400

H 50



9 002759 970826



L 600

H 50



9 002759 970833



L 780

H 50



97083

LED



IP44





99731



IP44



98908



IP44



98677



IP44

99731 PANDELLA 2

mirror light; aluminium, plastic, black / plastic, white
Spiegelleuchte; Alu, Kunststoff, schwarz / Kunststoff, weiss
applique pour miroir; aluminium, plastique, noir / plastique, blanc

L 600, H 40, A 120



11W



1400lm



IP44



98908 PANDELLA 1

mirror light; aluminium, plastic, black / plastic, white
Spiegelleuchte; Alu, Kunststoff, schwarz / Kunststoff, weiss
applique pour miroir; aluminium, plastique, noir / plastique, blanc

L 600, H 40, A 120



11W



1350lm



IP44



98677 PANDELLA 1

mirror light; aluminium, plastic, black / plastic, white
Spiegelleuchte; Alu, Kunststoff, schwarz / Kunststoff, weiss
applique pour miroir; aluminium, plastique, noir / plastique, blanc

L 780, H 40, A 120



14W



1700lm



IP44



9 002759 997311



L 600

H 40



9 002759 989088



L 600

H 40



9 002759 986773

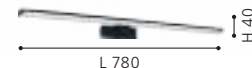

L 780

H 40

98907



IP44

DESIGN
HIGHLIGHT
DETAIL



98907 PANDELLA 1

mirror light; aluminium, plastic, black / plastic, white
Spiegelleuchte; Alu, Kunststoff, schwarz / Kunststoff, weiss
applique pour miroir; aluminium, plastique, noir / plastique,
blanc

L 400, H 40, A 120



7,4W



900lm



IP44



9 002759 989071





96064



IP44



96065



IP44



96066



IP44

96064 PANDELLA 1

mirror light; aluminium, plastic, chrome, silver / plastic, white
Spiegelleuchte; Alu, Kunststoff, chrom, silber / Kunststoff, weiss
applique pour miroir; aluminium, plastique, chrome, argent /
plastique, blanc

L 400, H 40, A 120



7,4W



900lm



IP44



96065 PANDELLA 1

mirror light; aluminium, plastic, chrome, silver / plastic, white
Spiegelleuchte; Alu, Kunststoff, chrom, silber / Kunststoff, weiss
applique pour miroir; aluminium, plastique, chrome, argent /
plastique, blanc

L 600, H 40, A 120



11W



1350lm



IP44



96066 PANDELLA 1

mirror light; aluminium, plastic, chrome, silver / plastic, white
Spiegelleuchte; Alu, Kunststoff, chrom, silber / Kunststoff, weiss
applique pour miroir; aluminium, plastique, chrome, argent /
plastique, blanc

L 780, H 40, A 120



14W



1700lm



IP44



9 002759 960643



9 002759 960650



9 002759 960667

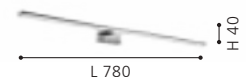



99297



IP44

99297 PANDELLA 1

mirror light; aluminium, plastic, chrome, silver / plastic, white
Spiegelleuchte; Alu, Kunststoff, chrom, silber / Kunststoff, weiss
applique pour miroir; aluminium, plastique, chrome, argent /
plastique, blanc

L 1200, H 40, A 120

13,5W	1750lm	IP44	

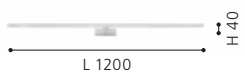

DESIGN
HIGHLIGHT
DETAIL



97059



IP44

97059

These luminaires are equipped with an integrated motion sensor. The sensor is invisibly mounted behind the housing.

Diese Leuchten sind mit einem integrierten Bewegungssensor ausgestattet. Der Sensor ist unsichtbar hinter dem Gehäuse befestigt.

Ces luminaires sont équipés d'un capteur de mouvement intégré. Le capteur est fixé de manière invisible derrière le boîtier.

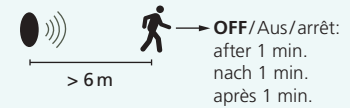
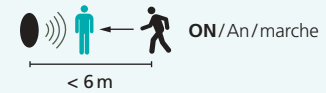
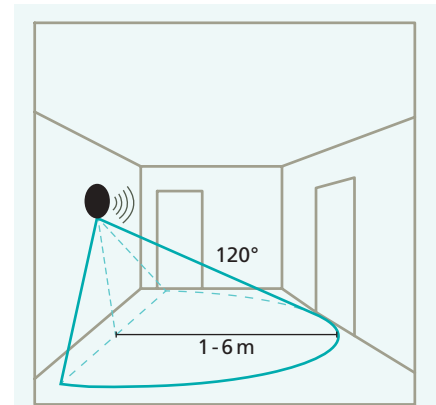

VINCHIO

These luminaires are delivered with a wiring and connection box that is 19.5 mm deep.

Diese Leuchten werden mit einer Verkabelungs- und Anschlussbox mit einer Tiefe von 19,5 mm geliefert.

Cette luminaires sont livrés avec un boîtier de câblage et de connexion d'une profondeur de 19,5 mm.



98501



IP44

97059 PANDELLA 2

mirror light; plastic, silver, chrome / plastic, white
Spiegelleuchte; Kunststoff, silber, chrom / Kunststoff, weiss
applique pour miroir; plastique, argent, chrome / plastique, blanc

L 400, H 75, A 150



7,4W



900lm



IP44



9 002759 970598



98501 VINCHIO

mirror light; steel, chrome / plastic, white
Spiegelleuchte; Stahl, chrom / Kunststoff, weiss
applique pour miroir; acier, chrome / plastique, blanc

L 400, H 50, A 140



9W



1050lm



IP44



9 002759 985011



98502 VINCHIO

mirror light; steel, chrome / plastic, white
Spiegelleuchte; Stahl, chrom / Kunststoff, weiss
applique pour miroir; acier, chrome / plastique, blanc

L 600, H 50, A 140



13,6W



1600lm



IP44



9 002759 985028

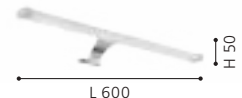



98502

LED



IP44



87219



IP44



87222



IP44



83406



83406 | 87219 | 87222

87219 PALMERA

wall light; steel, chrome / matte-opal glass, white
Wandleuchte; Stahl, chrom / Glas opal-matt, weiss
Applique; acier, chrome / verre opale mat, blanc

L 460, A 110



E14



2x 40W



IP44



9 002759 872199



L 460

87222 PALMERA

wall light; steel, satin nickel / matte-opal glass, white
Wandleuchte; Stahl, nickel-matt / Glas opal-matt, weiss
Applique; acier, nickel mat / verre opale mat, blanc

L 460, A 110



E14



2x 40W



IP44



9 002759 872229



L 460

83406 ZOLA

wall light; steel / matte-opal glass, white
Wandleuchte; Stahl / Glas opal-matt, weiss
Applique; acier / verre opale mat, blanc

L 390, B 80



E14



2x 40W



9 002759 834067

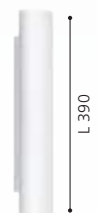

B 80

L 390



94987



85832

94987 BARI 1

mirror light; plastic, white / grooved glass, white
Spiegelleuchte; Kunststoff, weiss / Glas gerillt, weiss
applique pour miroir; plastique, blanc / verre rainuré, blanc

L 350, B 60, A 85



E14 2x 25W



9 002759 949877



85832 STICKER

mirror light; steel, chrome / matte-opal glass, white
Spiegelleuchte; Stahl, chrom / Glas opal-matt, weiss
applique pour miroir; acier, chrome / verre opale mat, blanc

L 70, H 115, A 95



E14 1x 40W



9 002759 858322



94987

These luminaires are equipped with an integrated socket.

Diese Leuchten sind mit einer integrierten Steckdose ausgestattet.

Ces luminaires sont équipés d'une prise de courant intégrée.



99774



IP44



99772



IP44

99774 BUENAVISTA

mirror light; aluminium, silver / mirror
Spiegelleuchte; Alu, silber / Spiegel
applique pour miroir; aluminium, argent / miroir

Ø 600, A 30



15,3W



1700lm



IP44



9 002759 997748



Ø 600

99772 BUENAVISTA

mirror light; aluminium, silver / mirror
Spiegelleuchte; Alu, silber / Spiegel
applique pour miroir; aluminium, argent / miroir

L 500, H 700, A 30



2x 6,1W



1300lm



IP44



9 002759 997724



L 500

H 700

99773 BUENAVISTA

mirror light; aluminium, silver / mirror
Spiegelleuchte; Alu, silber / Spiegel
applique pour miroir; aluminium, argent / miroir

L 800, H 600, A 30



2x 5,1W



1100lm



IP44



9 002759 997731



L 800

H 600



99773



IP44



99838



IP44



99839



IP44

99838 BUENAVISTA 1

mirror light; aluminium, silver / mirror
Spiegelleuchte; Alu, silber / Spiegel
applique pour miroir; aluminium, argent / miroir

L 500, H 700, A 30



15,7W



1700lm



IP44



9 002759 998387



L 500

H 700

99839 BUENAVISTA 1

mirror light; aluminium, silver / mirror
Spiegelleuchte; Alu, silber / Spiegel
applique pour miroir; aluminium, argent / miroir

L 800, H 600, A 30



18,6W



2030lm



IP44



9 002759 998394

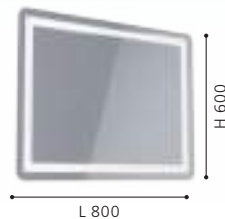

L 800

H 600

99853 BUENAVISTA 2

mirror light; aluminium, silver / mirror
Spiegelleuchte; Alu, silber / Spiegel
applique pour miroir; aluminium, argent / miroir

L 500, H 700, A 30



4x 7,1W



3000lm



IP44



9 002759 998530



L 500

H 700



99853



IP44



99854



IP44

99854 BUENAVISTA 2

mirror light; aluminium, silver / mirror

Spiegelleuchte; Alu, silber / Spiegel

applique pour miroir; aluminium, argent / miroir

L 800, H 600, A 30



4x 6,2 W



2600 lm



ON/OFF



IP44



9 002759 998547

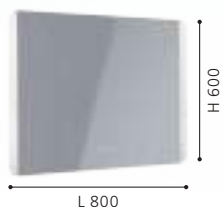

L 800

H 600

BUENAVISTA 2

The additional anti-fog function prevents the mirrors from fogging up and ensures a clear view after showering.

Die zusätzliche Anti-Fog-Funktion verhindert das Beschlagen der Spiegel und sorgt für eine klare Sicht nach dem Duschen.

La fonction anti-buée supplémentaire empêche la formation de buée sur les miroirs et garantit une vision claire après la douche.



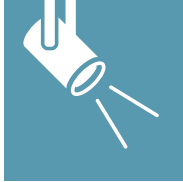

SPOT & TRACK LUMINAIRES

SPOT- & SCHIENENLEUCHTEN
SPOT & LUMINAIRES SUR RAIL



EN SYSTEMATIC LIGHTING

Our spot & track luminaires set specific highlights while optimally lighting your living rooms. No matter whether you prefer a modern or a traditional look – our range will fit any taste.

DE BELEUCHTUNG MIT SYSTEM

Mit unseren Spot- & Schienenleuchten setzen Sie gezielt Lichtakzente und sorgen zugleich für eine optimale Ausleuchtung Ihrer Wohnräume. Egal ob modern oder traditionell - unser Sortiment trifft jeden Geschmack.

FR UN ÉCLAIRAGE AVEC SYSTÈME

Nos spots et nos luminaires sur rail vous permettent d'offrir des accents ponctuels de lumière et assurent parallèlement un éclairage optimal de vos pièces d'habitat. Qu'ils soient modernes ou traditionnels - notre gamme répond à tous les goûts.





OVERVIEW

SPOT & TRACK LUMINAIRES
SPOT- & SCHIENENLEUCHTEN
SPOT & LUMINAIRES

 TOWNSHEND 3 682-685	 BATALLAS 686-687	 COTORRO 689	 ESTEPERRA 690	 VALBIANO 691	 POLLICA 692	 BERREGAS 694	 CONSACA 696
 CASIBARE 698	 COSWARTH 700	 ARRECIFE 703	 CAROVIGNO 704	 SAMBATELLO 706-709	 COSLADA 710	 GIRONA 713	 TABILLANO 714
 ZAPATA 1 716	 ZAPATA 719	 SERAS 1 720-721	 SERAS 722-723, 726-727	 SERAS 2 724-725	 DAKAR 1 728-729	 ENEA 730-731	 CORATO 733
 BARNHAM 734-735	 NOCITO 736-737	 BIMEDA 738-741	 LOCANDA 739	 CAYUCA 743	 SOREGO 744	 VERGHIANO 745	 DAVIDA 746-747
 DAVIDA 1 748-749	 SARRIA 750-753	 ZERACO 753	 ROTTELO 754-755	 BUZZ-LED 756-761	 MAGNUM-LED 762-763	 CABO 1 764	 VILANOVA 764-765
 CARDILLIO 1 766-767, 769	 CARDILLIO 2 768-769	 SALTO 770-771					



This product is available in different colors and shapes. / Dieser Artikel ist in unterschiedlichen Farben und Formen verfügbar. / Cet article est disponible en différentes couleurs et formes.





33169 TOWNSHEND 3

spot; wood, steel, brown, white
 Spot; Holz, Stahl, braun, weiss
 spot; bois, acier, marron, blanc

L 300, B 50



E27

2x 60W

33171 TOWNSHEND 3

spot; wood, steel, brown, white
 Spot; Holz, Stahl, braun, weiss
 spot; bois, acier, marron, blanc

L 480, B 50



E27

3x 60W

33172 TOWNSHEND 3

spot; wood, steel, brown, white
 Spot; Holz, Stahl, braun, weiss
 spot; bois, acier, marron, blanc

L 630, B 50



E27

4x 60W



9 002759 331696



L 300



9 002759 331719



L 480



9 002759 331726



L 630



33172



33168

33168 TOWNSHEND 3

spot; wood, steel, brown, white
 Spot; Holz, Stahl, braun, weiss
 spot; bois, acier, marron, blanc

L 165, B 50



9 002759 331689

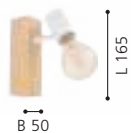



98112 TOWNSHEND 3

spot; wood, steel, brown, black
 Spot; Holz, Stahl, braun, schwarz
 spot; bois, acier, marron, noir

L 300, B 50



E27



2x 60W

98113 TOWNSHEND 3

spot; wood, steel, brown, black
 Spot; Holz, Stahl, braun, schwarz
 spot; bois, acier, marron, noir

L 480, B 50



E27



3x 60W

98114 TOWNSHEND 3

spot; wood, steel, brown, black
 Spot; Holz, Stahl, braun, schwarz
 spot; bois, acier, marron, noir

L 630, B 50



E27



4x 60W



9 002759 981129

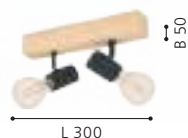

9 002759 981136



9 002759 981143





98114



98111

98111 TOWNSHEND 3

spot; wood, steel, brown, black
 Spot; Holz, Stahl, braun, schwarz
 spot; bois, acier, marron, noir

L 165, B 50



E27



1x 10W



9 002759 981112

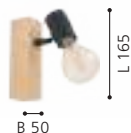



99488



99489



99491



99488 BATALLAS

spot; wood, steel, brown, black / fabric, black, white
 Spot; Holz, Stahl, braun, schwarz / Textil, schwarz, weiss
 spot; bois, acier, marron, noir / tissu, noir, blanc

L 100, H 170, A 205



E27

1x 10W

99489 BATALLAS

spot; wood, steel, brown, black / fabric, black, white
 Spot; Holz, Stahl, braun, schwarz / Textil, schwarz, weiss
 spot; bois, acier, marron, noir / tissu, noir, blanc

L 300, B 50



E27

2x 10W

99491 BATALLAS

spot; wood, steel, brown, black / fabric, black, white
 Spot; Holz, Stahl, braun, schwarz / Textil, schwarz, weiss
 spot; bois, acier, marron, noir / tissu, noir, blanc

L 480, B 50



E27

3x 10W



9 002759 994884



9 002759 994891



9 002759 994914





99492



99492 BATALLAS

spot; wood, steel, brown, black / fabric, black, white
Spot; Holz, Stahl, braun, schwarz / Textil, schwarz, weiss
spot; bois, acier, marron, noir / tissu, noir, blanc

L 630, B 50



E27



4x 10W



9 002759 994921



DESIGN
HIGHLIGHT
DETAIL





900433





900432



COTORRO



900434



900433 COTORRO

spot; wood, steel, brown, black
Spot; Holz, Stahl, braun, schwarz
spot; bois, acier, marron, noir

L 840, B 145, H 230



E27 3x 25W

900432 COTORRO

spot; wood, steel, brown, black
Spot; Holz, Stahl, braun, schwarz
spot; bois, acier, marron, noir

L 540, B 145, H 230



E27 2x 25W

900434 COTORRO

spot; wood, steel, brown, black
Spot; Holz, Stahl, braun, schwarz
spot; bois, acier, marron, noir

L 145, H 220, A 230



E27 1x 25W



9 008606 243891



9 008606 243884



9 008606 243907





99276 ESTEPERRA

spot; steel, black / fabric, black, gold
 Spot; Stahl, schwarz / Textil, schwarz, gold
 spot; acier, noir / tissu, noir, or

H 240, Ø 120



E27



1x 28W

99277 ESTEPERRA

spot; steel, black / fabric, black, gold
 Spot; Stahl, schwarz / Textil, schwarz, gold
 spot; acier, noir / tissu, noir, or

L 335, B 90



E27



2x 28W

99278 ESTEPERRA

spot; steel, black / fabric, black, gold
 Spot; Stahl, schwarz / Textil, schwarz, gold
 spot; acier, noir / tissu, noir, or

L 575, B 90



E27



3x 28W





97536

97537



97538

97536 VALBIANO

spot; steel, brushed brass, satin nickel / fabric, cappuccino, gold
 Spot; Stahl, messing-gebürstet, nickel-matt / Textil, cappuccino, gold
 spot; acier, laiton brossé, nickel mat / tissu, cappucino, or

L 110, B 110



E14 1x 7W

97537 VALBIANO

spot; steel, brushed brass, satin nickel / fabric, cappuccino, gold
 Spot; Stahl, messing-gebürstet, nickel-matt / Textil, cappuccino, gold
 spot; acier, laiton brossé, nickel mat / tissu, cappucino, or

L 320, B 70



E14 2x 7W

97538 VALBIANO

spot; steel, brushed brass, satin nickel / fabric, cappuccino, gold
 Spot; Stahl, messing-gebürstet, nickel-matt / Textil, cappuccino, gold
 spot; acier, laiton brossé, nickel mat / tissu, cappucino, or

L 560, B 70

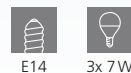

E14 3x 7W



9 002759 975364

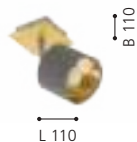

L 110



9 002759 975371

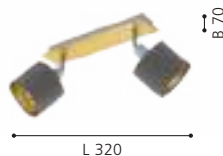

L 320



9 002759 975388



L 560



98624



POLLICA



98625

98624 POLLICA

spot; steel, black / glass vaporized, black-transparent
Spot; Stahl, schwarz / Glas bedampft, schwarz-transparent
spot; acier, noir / verre vaporisé, noir transparent

L 65, H 105



E14

1x 10W

98625 POLLICA

spot; steel, black / glass vaporized, black-transparent
Spot; Stahl, schwarz / Glas bedampft, schwarz-transparent
spot; acier, noir / verre vaporisé, noir transparent

L 365, B 165



E14

2x 28W

98626 POLLICA

spot; steel, black / glass vaporized, black-transparent
Spot; Stahl, schwarz / Glas bedampft, schwarz-transparent
spot; acier, noir / verre vaporisé, noir transparent

L 640, B 220



E14

4x 28W



9 002759 986247



9 002759 986254



9 002759 986261





98626





99052



99053

99052 BERREGAS

spot; steel, black, chrome / glass vaporized, black-transparent
 Spot; Stahl, schwarz, chrom / Glas bedampft, schwarz-transparent
 spot; acier, noir, chrome / verre vaporisé, noir transparent

Ø 110



E27 1x 28W

99053 BERREGAS

spot; steel, black, chrome / glass vaporized, black-transparent
 Spot; Stahl, schwarz, chrom / Glas bedampft, schwarz-transparent
 spot; acier, noir, chrome / verre vaporisé, noir transparent

L 440, B 110



E27 2x 40W

99054 BERREGAS

spot; steel, black, chrome / glass vaporized, black-transparent
 Spot; Stahl, schwarz, chrom / Glas bedampft, schwarz-transparent
 spot; acier, noir, chrome / verre vaporisé, noir transparent

L 775, B 110



E27 3x 40W



9 002759 990527



Ø 110



9 002759 990534



L 440

B 110



9 002759 990541



L 775

B 110



99054



99711



CONSACA



99713

99711 CONSACA

spot; steel, black / glass vaporized, black-transparent
Spot; Stahl, schwarz / Glas bedampft, schwarz-transparent
spot; acier, noir / verre vaporisé, noir transparent

L 120, H 220, A 235



E27



1x 28W

99713 CONSACA

spot; steel, black / glass vaporized, black-transparent
Spot; Stahl, schwarz / Glas bedampft, schwarz-transparent
spot; acier, noir / verre vaporisé, noir transparent

L 780, H 205, A 235



E27



4x 40W

99712 CONSACA

spot; steel, black / glass vaporized, black-transparent
Spot; Stahl, schwarz / Glas bedampft, schwarz-transparent
spot; acier, noir / verre vaporisé, noir transparent

L 340, H 205, A 235



E27



2x 40W



9 002759 997113



9 002759 997137



9 002759 997120





99712



99517



99518

99517 CASIBARE

spot; steel, black
Spot; Stahl, schwarz
spot; acier, noir

L 120, H 185, A 190



E27



1x 28W

99518 CASIBARE

spot; steel, black
Spot; Stahl, schwarz
spot; acier, noir

L 335, H 175, A 180



E27



2x 28W

99519 CASIBARE

spot; steel, black
Spot; Stahl, schwarz
spot; acier, noir

L 575, H 175, A 180



E27



3x 28W



9 002759 995171



9 002759 995188



9 002759 995195





99519





99075



99076

99075 COSWARTH

spot; steel, wood, anthracite, cream-white, brown
Spot; Stahl, Holz, anthrazit, creme-weiss, braun
spot; acier, bois, gris anthracite, blanc crème,

L 480, B 140, H 240



E27



2x 40W

99076 COSWARTH

spot; steel, wood, anthracite, cream-white, brown
Spot; Stahl, Holz, anthrazit, creme-weiss, braun
spot; acier, bois, gris anthracite, blanc crème,

L 670, B 140, H 240



E27



3x 40W

99074 COSWARTH

spot; steel, wood, anthracite, cream-white, brown
Spot; Stahl, Holz, anthrazit, creme-weiss, braun
spot; acier, bois, gris anthracite, blanc crème,

L 140, H 200



E27



1x 25W



9 002759 990756



L 480



9 002759 990763



L 670



9 002759 990749

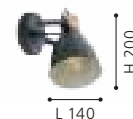

L 140



99074



900713





900712



900711

900713 ARRECIFE

spot; steel, brown, satin nickel / steel, sandy
 Spot; Stahl, braun, nickel-matt / Stahl, sandfarben
 spot; acier, marron, nickel mat / acier, couleur sable

L 745, B 145, H 235



E27 3x 28W



9 008606 262045



900712 ARRECIFE

spot; steel, brown, satin nickel / steel, sandy
 Spot; Stahl, braun, nickel-matt / Stahl, sandfarben
 spot; acier, marron, nickel mat / acier, couleur sable

L 531, B 145, H 235



E27 2x 28W



9 008606 262038



900711 ARRECIFE

spot; steel, brown, satin nickel / steel, sandy
 Spot; Stahl, braun, nickel-matt / Stahl, sandfarben
 spot; acier, marron, nickel mat / acier, couleur sable

H 235, Ø 145



E27 1x 28W



9 008606 262021





98621



98623

98621 CAROVIGNO

spot; steel, black
Spot; Stahl, schwarz
spot; acier, noir

L 65, H 105



E14

1x 28W

98623 CAROVIGNO

spot; steel, black
Spot; Stahl, schwarz
spot; acier, noir

L 640, B 150



E14

4x 40W

98622 CAROVIGNO

spot; steel, black
Spot; Stahl, schwarz
spot; acier, noir

L 365, B 150



E14

2x 40W



9 002759 986216



9 002759 986230

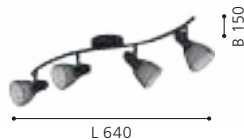

9 002759 986223





98622



98134



98135



98137

98134 SAMBATELLO

spot; wood, steel, brown, silver / steel, silver
 Spot; Holz, Stahl, braun, silber / Stahl, silber
 spot; bois, acier, marron, argent / acier, argent

L 150, H 220, A 240



E27

1x 40W

98135 SAMBATELLO

spot; wood, steel, brown, silver / steel, silver
 Spot; Holz, Stahl, braun, silber / Stahl, silber
 spot; bois, acier, marron, argent / acier, argent

L 335, B 90



E27

2x 40W

98137 SAMBATELLO

spot; wood, steel, brown, silver / steel, silver
 Spot; Holz, Stahl, braun, silber / Stahl, silber
 spot; bois, acier, marron, argent / acier, argent

L 795, B 90



E27

4x 40W



9 002759 981341

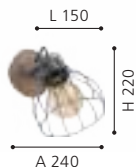

9 002759 981358

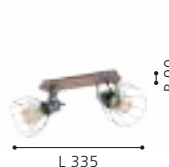

9 002759 981372





98136

98136 SAMBATELLO

spot; wood, steel, brown, silver / steel, silver
Spot; Holz, Stahl, braun, silber / Stahl, silber
spot; bois, acier, marron, argent / acier, argent

L 575, B 90



E27



3x 40W



9 002759 981365





900382





900382 SAMBATELLO

spot; steel, wood, black, brushed brass
 Spot; Stahl, Holz, schwarz, messing-gebürstet
 spot; acier, bois, noir, laiton brossé

L 260, B 150, H 220



900383 SAMBATELLO

spot; steel, wood, black, brushed brass
 Spot; Stahl, Holz, schwarz, messing-gebürstet
 spot; acier, bois, noir, laiton brossé

L 480, B 280, H 260



900384 SAMBATELLO

spot; steel, wood, black, brushed brass
 Spot; Stahl, Holz, schwarz, messing-gebürstet
 spot; acier, bois, noir, laiton brossé

L 700, B 280, H 260





900693



900694



EGLO
RECOMMENDS
110052

COSLADA

900693 COSLADA

spot; steel, black / steel, black, brass
Spot; Stahl, schwarz / Stahl, schwarz, messing
spot; acier, noir / acier, noir, laiton

L 130, H 200, A 170



E27



1x 40W

900694 COSLADA

spot; steel, black / steel, black, brass
Spot; Stahl, schwarz / Stahl, schwarz, messing
spot; acier, noir / acier, noir, laiton

L 320, B 80, H 170



E27



2x 40W

900695 COSLADA

spot; steel, black / steel, black, brass
Spot; Stahl, schwarz / Stahl, schwarz, messing
spot; acier, noir / acier, noir, laiton

L 790, B 80, H 170



E27



4x 40W



9 008606 262052



9 008606 262069



9 008606 262076





900695





900662





GIRONA



900661



900663

900662 GIRONA

spot; steel, black, brushed brass
Spot; Stahl, schwarz, messing-gebürstet
spot; acier, noir, laiton brossé

L 440, B 190, H 150



E27 2x 40W

900661 GIRONA

spot; steel, black, brushed brass
Spot; Stahl, schwarz, messing-gebürstet
spot; acier, noir, laiton brossé

L 190, B 140, H 150



E27 1x 40W

900663 GIRONA

spot; steel, black, brushed brass
Spot; Stahl, schwarz, messing-gebürstet
spot; acier, noir, laiton brossé

L 775, B 190, H 150



E27 3x 40W



9 008606 258598



9 008606 258581



L 190



9 008606 258604



L 775



98763 TABILLANO

spot; steel, black
Spot; Stahl, schwarz
spot; acier, noir

L 440, B 110



E27

2x 40W

98764 TABILLANO

spot; steel, black
Spot; Stahl, schwarz
spot; acier, noir

L 775, B 110



E27

3x 40W

98762 TABILLANO

spot; steel, black
Spot; Stahl, schwarz
spot; acier, noir

Ø 110



E27

1x 40W



9 002759 987633

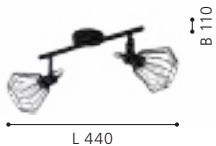

9 002759 987640



9 002759 987626





98762





32765

LED



32767

LED

32765 ZAPATA 1

spot; steel, black / glass, amber
Spot; Stahl, schwarz / Glas, amber
spot; acier, noir / verre, ambre

Ø 60



G9



1x 3W



1x
320lm

32767 ZAPATA 1

spot; steel, black / glass, amber
Spot; Stahl, schwarz / Glas, amber
spot; acier, noir / verre, ambre

L 635, B 65



G9



4x 3W



4x
320lm

32766 ZAPATA 1

spot; steel, black / glass, amber
Spot; Stahl, schwarz / Glas, amber
spot; acier, noir / verre, ambre

L 360, B 65



G9



2x 3W



2x
320lm



9 002759 327651



Ø 60



9 002759 327675



L 635

B 65



9 002759 327668



L 360

B 65



32766

LED



95547

LED



95546

LED



95545

LED

DESIGN
HIGHLIGHT
DETAIL



95547 ZAPATA

spot; steel, copper / satin glass, white
Spot; Stahl, kupfer / Glas satiniert, weiss
spot; acier, cuivre / verre satiné, blanc

L 515, B 65

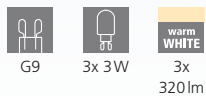

95546 ZAPATA

spot; steel, copper / satin glass, white
Spot; Stahl, kupfer / Glas satiniert, weiss
spot; acier, cuivre / verre satiné, blanc

L 360, B 65

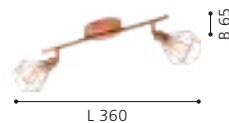
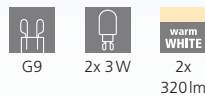

95545 ZAPATA

spot; steel, copper / satin glass, white
Spot; Stahl, kupfer / Glas satiniert, weiss
spot; acier, cuivre / verre satiné, blanc

Ø 60





98393

LED



98394

LED



98396

LED

98393 SERAS 1

spot; steel, white
Spot; Stahl, weiss
spot; acier, blanc

Ø 100



GU10



1x 3W



1x
warm
WHITE
250lm

98394 SERAS 1

spot; steel, white
Spot; Stahl, weiss
spot; acier, blanc

L 370, B 65



GU10



2x 3W



2x
warm
WHITE
250lm

98396 SERAS 1

spot; steel, white
Spot; Stahl, weiss
spot; acier, blanc

L 770, B 65



GU10



4x 3W



4x
warm
WHITE
250lm



9 002759 983932



Ø 100



9 002759 983949



L 370



9 002759 983963



L 770



98395

LED

98395 SERAS 1

spot; steel, white
Spot; Stahl, weiss
spot; acier, blanc

L 595, B 65



GU10



3x 3W



warm
WHITE
3x
250lm



9 002759 983956



INCL.





96552

LED



DESIGN
HIGHLIGHT
DETAIL

96552 SERAS

spot; steel, antique nickel, cream
Spot; Stahl, nickel-antik, creme
spot; acier, nickel antique, crème

Ø 100



GU10



1x 3W



warm
WHITE

1x

250lm



9 002759 965525



INCL.

Ø 100





96553



96554



96555



96553 SERAS

spot; steel, antique nickel, cream
Spot; Stahl, nickel-antik, creme
spot; acier, nickel antique, crème

L 370, B 65



GU10



2x 3W



2x
warm
WHITE
250lm

96554 SERAS

spot; steel, antique nickel, cream
Spot; Stahl, nickel-antik, creme
spot; acier, nickel antique, crème

L 595, B 65



GU10



3x 3W



3x
warm
WHITE
250lm

96555 SERAS

spot; steel, antique nickel, cream
Spot; Stahl, nickel-antik, creme
spot; acier, nickel antique, crème

L 770, B 65



GU10



4x 3W



4x
warm
WHITE
250lm



9 002759 965532



L 370



9 002759 965549



L 595



9 002759 965556



L 770



98398

LED



98397

LED

98398 SERAS 2

spot; steel, black
Spot; Stahl, schwarz
spot; acier, noir

L 370, B 65



GU10



2x 3W



warm
WHITE
2x
250lm



9 002759 983987



INCL.





98399

LED



98408

LED

98397 SERAS 2

spot; steel, black
Spot; Stahl, schwarz
spot; acier, noir

Ø 100



GU10



1x 3W



warm
WHITE

1x

250lm

98399 SERAS 2

spot; steel, black
Spot; Stahl, schwarz
spot; acier, noir

L 595, B 65



GU10



3x 3W



warm
WHITE

3x

250lm

98408 SERAS 2

spot; steel, black
Spot; Stahl, schwarz
spot; acier, noir

L 770, B 65



GU10



4x 3W



warm
WHITE

4x

250lm



9 002759 983970



Ø 100



9 002759 983994



L 595

B 65



9 002759 984083



L 770

B 65



900169

LED



900171

LED



900173

LED

900169 SERAS

spot; steel, brushed brass, gold
Spot; Stahl, messing-gebürstet, gold
spot; acier, laiton brossé, or

Ø 100



GU10



1x 3W



1x
250lm

900171 SERAS

spot; steel, brushed brass, gold
Spot; Stahl, messing-gebürstet, gold
spot; acier, laiton brossé, or

L 370, B 65



GU10



2x 3W



2x
250lm

900173 SERAS

spot; steel, brushed brass, gold
Spot; Stahl, messing-gebürstet, gold
spot; acier, laiton brossé, or

L 770, B 65



GU10



4x 3W



4x
250lm



9 008606 235643



9 008606 235650



9 008606 235674





900172

LED

900172 SERAS

spot; steel, brushed brass, gold
Spot; Stahl, messing-gebürstet, gold
spot; acier, laiton brossé, or

L 595, B 65



GU10



3x 3W



warm
WHITE
3x
250lm



9 008606 235667





88472

DESIGN
HIGHLIGHT
DETAIL



88473



88472 DAKAR 1

spot; steel, satin nickel / glass wiping technique, white
Spot; Stahl, nickel-matt / Glas Wischtechnik, weiss
spot; acier, nickel mat / technique de verre essuyé, blanc

L 105, B 65



E14



1x 25W

88473 DAKAR 1

spot; steel, satin nickel / glass wiping technique, white
Spot; Stahl, nickel-matt / Glas Wischtechnik, weiss
spot; acier, nickel mat / technique de verre essuyé, blanc

L 370, B 100



E14



2x 40W



9 002759 884727



L 105



9 002759 884734



L 370



88474



88475

88474 DAKAR 1

spot; steel, satin nickel / glass wiping technique, white
 Spot; Stahl, nickel-matt / Glas Wischtechnik, weiss
 spot; acier, nickel mat / technique de verre essuyé, blanc

L 650, B 100



9 002759 88474 1

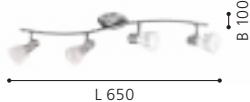

88475 DAKAR 1

spot; steel, satin nickel / glass wiping technique, white
 Spot; Stahl, nickel-matt / Glas Wischtechnik, weiss
 spot; acier, nickel mat / technique de verre essuyé, blanc

Ø 295



9 002759 88475 8





90984



90986



90985

90984 ENEC

spot; steel, satin nickel / satin glass, white
Spot; Stahl, nickel-matt / Glas satiniert, weiss
spot; acier, nickel mat / verre satiné, blanc

L 300, B 70



E14

2x 40W

90986 ENEC

spot; steel, satin nickel / satin glass, white
Spot; Stahl, nickel-matt / Glas satiniert, weiss
spot; acier, nickel mat / verre satiné, blanc

Ø 265



E14

3x 40W

90985 ENEC

spot; steel, satin nickel / satin glass, white
Spot; Stahl, nickel-matt / Glas satiniert, weiss
spot; acier, nickel mat / verre satiné, blanc

L 500, B 70



E14

3x 40W



9 002759 909840



9 002759 909864



9 002759 909857

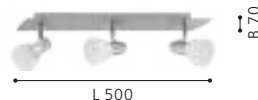



90982

90982 ENEA

spot; steel, satin nickel / satin glass, white
Spot; Stahl, nickel-matt / Glas satiniert, weiss
spot; acier, nickel mat / verre satiné, blanc

L 190, B 70



E14



1x 25W



9 002759 909826

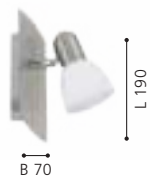



900715



900714



900716

900715 CORATO

spot; steel, sandy, satin nickel / glass, white
 Spot; Stahl, sandfarben, nickel-matt / Glas, weiss
 spot; acier, couleur sable, nickel mat / verre, blanc

L 300, H 125, A 150

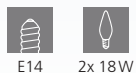

E14 2x 18W

900714 CORATO

spot; steel, sandy, satin nickel / glass, white
 Spot; Stahl, sandfarben, nickel-matt / Glas, weiss
 spot; acier, couleur sable, nickel mat / verre, blanc

L 85, H 125, A 150

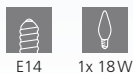

E14 1x 18W

900716 CORATO

spot; steel, sandy, satin nickel / glass, white
 Spot; Stahl, sandfarben, nickel-matt / Glas, weiss
 spot; acier, couleur sable, nickel mat / verre, blanc

L 520, H 125, A 150

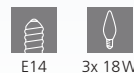

E14 3x 18W



9 008606 262120



L 300

H 125



9 008606 262113

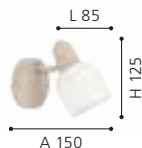

L 85

A 150

H 125



9 008606 262137



L 520

H 125



94585

LED



94586

LED

94585 BARNHAM

spot; steel, black, copper
Spot; Stahl, schwarz, kupfer
spot; acier, noir, cuivre

L 395, B 70



GU10



2x 3W



warm
WHITE

2x
250lm



9 002759 945855



L 395

94586 BARNHAM

spot; steel, black, copper
Spot; Stahl, schwarz, kupfer
spot; acier, noir, cuivre

L 585, B 70



GU10



3x 3W



warm
WHITE

3x
250lm



9 002759 945862



L 585

94587 BARNHAM

spot; steel, black, copper
Spot; Stahl, schwarz, kupfer
spot; acier, noir, cuivre

L 780, B 70



GU10



4x 3W



warm
WHITE

4x
250lm



9 002759 945879



L 780



94587

LED



94584

LED

94584 BARNHAM

spot; steel, black, copper
Spot; Stahl, schwarz, kupfer
spot; acier, noir, cuivre

L 165, B 70



GU10



1x 3W



warm
WHITE
1x
250lm



9 002759 945848

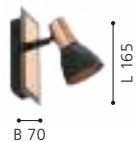



95482

LED



95483

LED



95485

LED

95482 NOCITO

spot; steel, black, gold
Spot; Stahl, schwarz, gold
spot; acier, noir, or

Ø 110



GU10



1x 3W



1x
warm
WHITE
250lm

95483 NOCITO

spot; steel, black, gold
Spot; Stahl, schwarz, gold
spot; acier, noir, or

L 360, B 105



GU10



2x 3W



2x
warm
WHITE
250lm

95485 NOCITO

spot; steel, black, gold
Spot; Stahl, schwarz, gold
spot; acier, noir, or

L 760, B 105



GU10



4x 3W



4x
warm
WHITE
250lm



9 002759 954826



Ø 110



9 002759 954833



L 360

B 105



9 002759 954857



L 760

B 105



95484

LED

95484 NOCITO

spot; steel, black, gold
Spot; Stahl, schwarz, gold
spot; acier, noir, or

L 585, B 105



GU10



3x 3W



warm
WHITE
3x
250lm



9 002759 954840



DESIGN
HIGHLIGHT
DETAIL



31001

LED



31002

LED



31004

LED

31001 BIMEDA

spot; steel, white, chrome
Spot; Stahl, weiss, chrom
spot; acier, blanc, chrome

Ø 70



GU10



1x 2,8W



1x
250lm

31002 BIMEDA

spot; steel, white, chrome
Spot; Stahl, weiss, chrom
spot; acier, blanc, chrome

L 365, B 100



GU10



2x 2,8W



2x
250lm

31004 BIMEDA

spot; steel, white, chrome
Spot; Stahl, weiss, chrom
spot; acier, blanc, chrome

L 640, B 100



GU10



4x 2,8W



4x
250lm



9 002759 310011



Ø 70



9 002759 310028



B 100

L 365



9 002759 310042



B 100

L 640



31003

LED

94252

LED

31003 BIMEDA

spot; steel, white, chrome
 Spot; Stahl, weiss, chrom
 spot; acier, blanc, chrome

L 290, H 345



GU10



3x 2,8W



warm
WHITE

3x
250lm



9 002759 310035

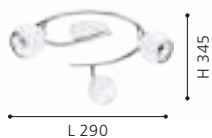

94252 LOCANDA

ceiling light; steel, white, chrome
 Deckenleuchte; Stahl, weiss, chrom
 plafonnier; acier, blanc, chrome

L 700, B 660



GU10



5x 2,8W



warm
WHITE

5x
250lm



9 002759 942526

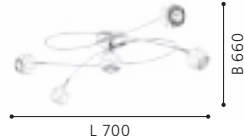



31005

LED



DESIGN
HIGHLIGHT
DETAIL

31005 BIMEDA

spot; steel, nickel-nero, chrome
Spot; Stahl, nickel-nero, chrom
spot; acier, nickel brillant, chrome

Ø 70



GU10



1x 2,8W



1x

250lm



9 002759 310059



INCL.





31006

LED



31007

LED



31008

LED

31006 BIMEDA

spot; steel, nickel-nero, chrome
Spot; Stahl, nickel-nero, chrom
spot; acier, nickel brillant, chrome

L 365, B 100

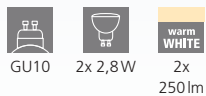

31007 BIMEDA

spot; steel, nickel-nero, chrome
Spot; Stahl, nickel-nero, chrom
spot; acier, nickel brillant, chrome

L 290, H 345

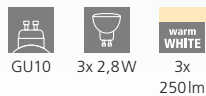

31008 BIMEDA

spot; steel, nickel-nero, chrome
Spot; Stahl, nickel-nero, chrom
spot; acier, nickel brillant, chrome

L 640, B 100

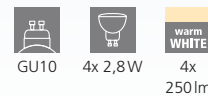

9 002759 310066



L 365



9 002759 310073



L 290



9 002759 310080



L 640



900438

LED



900436

LED



900437

LED

900438 CAYUCA

spot; steel, black / wood, brown
 Spot; Stahl, schwarz / Holz, braun
 spot; acier, noir / bois, marron

L 580, B 100, H 120

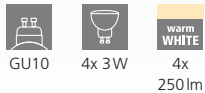

900436 CAYUCA

spot; steel, black / wood, brown
 Spot; Stahl, schwarz / Holz, braun
 spot; acier, noir / bois, marron

L 110, B 105, H 120



900437 CAYUCA

spot; steel, black / wood, brown
 Spot; Stahl, schwarz / Holz, braun
 spot; acier, noir / bois, marron

L 280, B 100, H 120

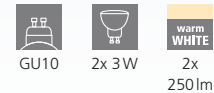

L 580



L 110



L 280



900331



900332



900333



900331 SOREGO

spot; steel, black
Spot; Stahl, schwarz
spot; acier, noir

L 110, B 105, H 120



GU10



1x 3W



warm
WHITE
1x
250lm

900332 SOREGO

spot; steel, black
Spot; Stahl, schwarz
spot; acier, noir

L 280, B 100, H 120



GU10



2x 3W



warm
WHITE
2x
250lm

900333 SOREGO

spot; steel, black
Spot; Stahl, schwarz
spot; acier, noir

L 580, B 100, H 120



GU10



4x 3W



warm
WHITE
4x
250lm



9 008606 239078



L 110



9 008606 239085



L 280



9 008606 239092



L 580



97506

LED



97507

LED



97508

LED

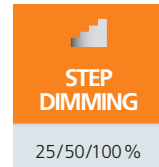

97506

97507

97508

97506 VERGIANO

spot; aluminium, steel, white, satin nickel
Spot; Alu, Stahl, weiss, nickel-matt
spot; aluminium, acier, blanc, nickel mat

L 70, H 165

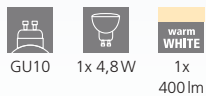

GU10 1x 4,8W 1x warm WHITE 400lm



9 002759 975067



97507 VERGIANO

spot; aluminium, steel, white, satin nickel
Spot; Alu, Stahl, weiss, nickel-matt
spot; aluminium, acier, blanc, nickel mat

L 390, B 70

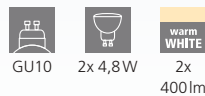

GU10 2x 4,8W 2x warm WHITE 400lm



9 002759 975074



L 390

97508 VERGIANO

spot; aluminium, steel, white, satin nickel
Spot; Alu, Stahl, weiss, nickel-matt
spot; aluminium, acier, blanc, nickel mat

L 690, B 70

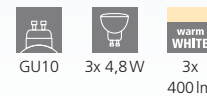

GU10 3x 4,8W 3x warm WHITE 400lm



9 002759 975081

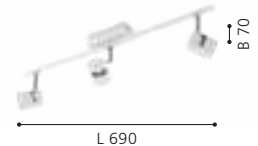

L 690



92084

LED



92085

LED



92086

LED

92084 DAVIDA

spot; steel, chrome, white
Spot; Stahl, chrom, weiss
spot; acier, chrome, blanc

L 165, B 70



GU10



1x 4,6W



1x
400lm



9 002759 920845



L 165

B 70

92085 DAVIDA

spot; steel, chrome, white
Spot; Stahl, chrom, weiss
spot; acier, chrome, blanc

L 390, B 70



GU10



2x 4,6W



2x
400lm



9 002759 920852



B 70

L 390

92086 DAVIDA

spot; steel, chrome, white
Spot; Stahl, chrom, weiss
spot; acier, chrome, blanc

L 580, B 70



GU10



3x 4,6W



3x
400lm



9 002759 920869



B 70

L 580



92087

LED

92087 DAVIDA

spot; steel, chrome, white
Spot; Stahl, chrom, weiss
spot; acier, chrome, blanc

L 780, B 70



GU10



4x 4,6 W



4x
warm
WHITE
400 lm



9 002759 920876

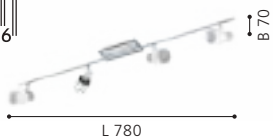

DESIGN
HIGHLIGHT
DETAIL





30833

LED



30832

LED

30832 DAVIDA 1

spot; steel, nickel-nero
Spot; Stahl, nickel-nero
spot; acier, nickel noir

L 165, B 70



GU10



1x 4,6W



warm
WHITE

1x

400lm



9 002759 308322



INCL.

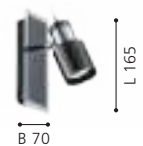



30834

LED



30835

LED

30833 DAVIDA 1

spot; steel, nickel-nero
Spot; Stahl, nickel-nero
spot; acier, nickel noir

L 390, B 70

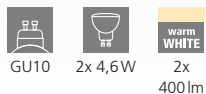

9 002759 308339



L 390

30834 DAVIDA 1

spot; steel, nickel-nero
Spot; Stahl, nickel-nero
spot; acier, nickel noir

L 580, B 70

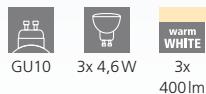

9 002759 308346



L 580

30835 DAVIDA 1

spot; steel, nickel-nero
Spot; Stahl, nickel-nero
spot; acier, nickel noir

L 780, B 70

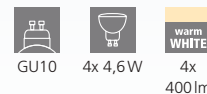

9 002759 308353



L 780



94962

LED



94958

LED

94962 SARRIA

spot; steel, white, chrome
Spot; Stahl, weiss, chrom
spot; acier, blanc, chrome

L 240, H 260



GU10



4x 4,5W



warm
WHITE
4x
345lm



9 002759 949624



INCL.



L 240

H 260



94959

LED



94961

LED

94958 SARRIA

spot; steel, white, chrome
Spot; Stahl, weiss, chrom
spot; acier, blanc, chrome

L 120, B 60

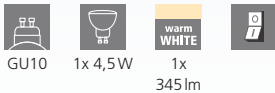

GU10 1x 4,5W 1x 345lm



9 002759 949587

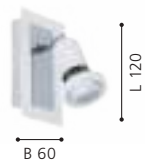

94959 SARRIA

spot; steel, white, chrome
Spot; Stahl, weiss, chrom
spot; acier, blanc, chrome

L 300, B 70

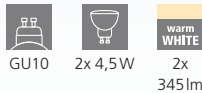

GU10 2x 4,5W 2x 345lm



9 002759 949594



94961 SARRIA

spot; steel, white, chrome
Spot; Stahl, weiss, chrom
spot; acier, blanc, chrome

L 460, B 70

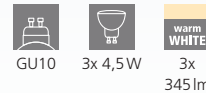

GU10 3x 4,5W 3x 345lm



9 002759 949617





94963



94966



94964



94963 SARRIA

spot; steel, black, chrome
Spot; Stahl, schwarz, chrom
spot; acier, noir, chrome

L 120, B 60

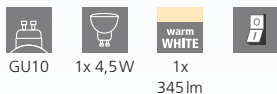

GU10 1x 4,5W 1x 345lm

94964 SARRIA

spot; steel, black, chrome
Spot; Stahl, schwarz, chrom
spot; acier, noir, chrome

L 300, B 70

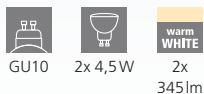

GU10 2x 4,5W 2x 345lm

94966 SARRIA

spot; steel, black, chrome
Spot; Stahl, schwarz, chrom
spot; acier, noir, chrome

L 240, H 260

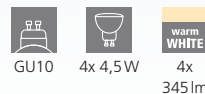

GU10 4x 4,5W 4x 345lm



9 002759 949631



9 002759 949648



9 002759 949662





94965

LED



93679

LED

94965 SARRIA

spot; steel, black, chrome
Spot; Stahl, schwarz, chrom
spot; acier, noir, chrome

L 460, B 70

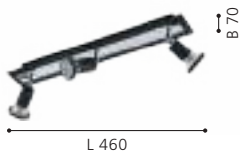
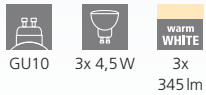

93679 ZERACO

spot; steel, plastic, satin nickel
Spot; Stahl, Kunststoff, nickel-matt
spot; acier, plastique, nickel mat

L 940, B 120

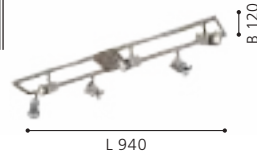
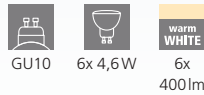



90915

LED



90914

LED



90916

LED

90915 ROTTELO

spot; steel, satin nickel, chrome
Spot; Stahl, nickel-matt, chrom
spot; acier, nickel mat, chrome

L 280, B 70

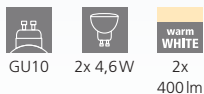

GU10

2x 4,6W

warm
WHITE
2x
400lm



9 002759 909154



L 280

B 70

90914 ROTTELO

spot; steel, satin nickel, chrome
Spot; Stahl, nickel-matt, chrom
spot; acier, nickel mat, chrome

L 120, B 60

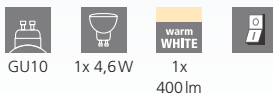

GU10

1x 4,6W

warm
WHITE
1x
400lm



9 002759 909147



B 60

L 120

90916 ROTTELO

spot; steel, satin nickel, chrome
Spot; Stahl, nickel-matt, chrom
spot; acier, nickel mat, chrome

L 260, B 240

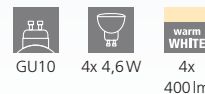

GU10

4x 4,6W

warm
WHITE
4x
400lm



9 002759 909161



L 260

B 240



90917



90927



90917 ROTTELO

spot; steel, satin nickel, chrome
 Spot; Stahl, nickel-matt, chrom
 spot; acier, nickel mat, chrome

L 780, B 70

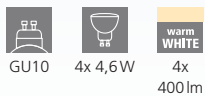

90927 ROTTELO

spot; steel, satin nickel, chrome
 Spot; Stahl, nickel-matt, chrom
 spot; acier, nickel mat, chrome

L 1160, B 70

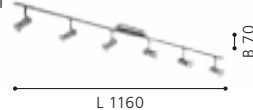
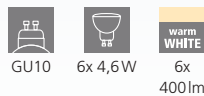



92595

LED



92596

LED



92597

LED

92595 BUZZ-LED

spot; steel, satin nickel
Spot; Stahl, nickel-matt
spot; acier, nickel mat

Ø 60



GU10



1x 2,8W



1x
warm
WHITE
250lm

92596 BUZZ-LED

spot; steel, satin nickel
Spot; Stahl, nickel-matt
spot; acier, nickel mat

L 285, B 65



GU10



2x 2,8W



2x
warm
WHITE
250lm

92597 BUZZ-LED

spot; steel, satin nickel
Spot; Stahl, nickel-matt
spot; acier, nickel mat

L 485, B 65



GU10



3x 2,8W



3x
warm
WHITE
250lm



9 002759 925956



Ø 60



9 002759 925963



L 285

B 65



9 002759 925970



L 485

B 65



92598

LED



92599

LED

92598 BUZZ-LED

spot; steel, satin nickel
Spot; Stahl, nickel-matt
spot; acier, nickel mat

L 685, B 65



GU10



4x 2,8W



4x
warm
WHITE
250lm



9 002759 925987

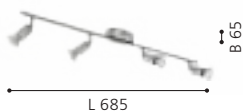

92599 BUZZ-LED

spot; steel, satin nickel
Spot; Stahl, nickel-matt
spot; acier, nickel mat

L 1050, B 65



GU10



6x 2,8W



6x
warm
WHITE
250lm



9 002759 925994

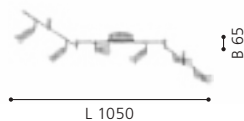



32428

LED



32429

LED



32431

LED

32428 BUZZ-LED

spot; steel, black
Spot; Stahl, schwarz
spot; acier, noir

Ø 60



GU10



1x 2,8W



warm
WHITE

1x

250lm

32429 BUZZ-LED

spot; steel, black
Spot; Stahl, schwarz
spot; acier, noir

L 285, B 65



GU10



2x 2,8W



warm
WHITE

2x

250lm

32431 BUZZ-LED

spot; steel, black
Spot; Stahl, schwarz
spot; acier, noir

L 485, B 65



GU10



3x 2,8W



warm
WHITE

3x

250lm



9 002759 324285



Ø 60



9 002759 324292



L 285

B 65



9 002759 324315



L 485

B 65



32432

LED



32433

LED

32432 BUZZ-LED

spot; steel, black
Spot; Stahl, schwarz
spot; acier, noir

L 685, B 65



32433 BUZZ-LED

spot; steel, black
Spot; Stahl, schwarz
spot; acier, noir

L 1050, B 65

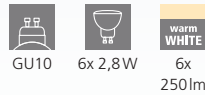

9 002759 324322



9 002759 324339

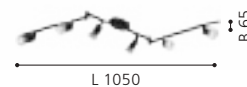



33184

LED



33185

LED



33186

LED

33184 BUZZ-LED

spot; steel, brushed brass
Spot; Stahl, messing-gebürstet
spot; acier, laiton brossé

Ø 60



GU10



1x 2,8W



1x
250lm

33185 BUZZ-LED

spot; steel, brushed brass
Spot; Stahl, messing-gebürstet
spot; acier, laiton brossé

L 285, B 65



GU10



2x 2,8W



2x
250lm

33186 BUZZ-LED

spot; steel, brushed brass
Spot; Stahl, messing-gebürstet
spot; acier, laiton brossé

L 485, B 65



GU10



3x 2,8W



3x
250lm



9 002759 331849



Ø 60



9 002759 331856



B 65

L 285



9 002759 331863



B 65

L 485



33187

LED

33187 BUZZ-LED

spot; steel, brushed brass
Spot; Stahl, messing-gebürstet
spot; acier, laiton brossé

L 685, B 65



GU10



4x 2,8W



4x
warm
WHITE
250lm



9 002759 331870

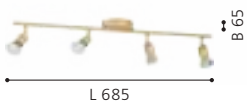



92642

LED



92641

LED



92643

LED

92641 MAGNUM-LED

spot; steel, satin nickel, chrome
Spot; Stahl, nickel-matt, chrom
spot; acier, nickel mat, chrome

Ø 70



GU10



1x 2,8W



1x
250lm

92642 MAGNUM-LED

spot; steel, satin nickel, chrome
Spot; Stahl, nickel-matt, chrom
spot; acier, nickel mat, chrome

L 330, B 105



GU10



2x 2,8W



2x
250lm

92643 MAGNUM-LED

spot; steel, satin nickel, chrome
Spot; Stahl, nickel-matt, chrom
spot; acier, nickel mat, chrome

L 255, H 295



GU10



3x 2,8W



3x
250lm



9 002759 926410



9 002759 926427



9 002759 926434





95824

LED



92644

LED



92645

LED

95824 MAGNUM LED

spot; steel, satin nickel, chrome
Spot; Stahl, nickel-matt, chrom
spot; acier, nickel mat, chrome

Ø 180

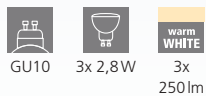

GU10 3x 2,8W 3x 250lm



9 002759 958244



Ø 180

92644 MAGNUM-LED

spot; steel, satin nickel, chrome
Spot; Stahl, nickel-matt, chrom
spot; acier, nickel mat, chrome

L 645, B 105

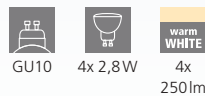

GU10 4x 2,8W 4x 250lm



9 002759 926444



L 645

92645 MAGNUM-LED

spot; steel, satin nickel, chrome
Spot; Stahl, nickel-matt, chrom
spot; acier, nickel mat, chrome

L 1050

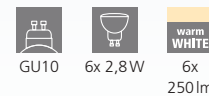

GU10 6x 2,8W 6x 250lm



9 002759 926458



L 1050



93359

LED



93085

LED



93358

93359



94609

93085 CABO 1

wall/ceiling light; steel, chrome / satin glass, white, clear
Wand- / Deckenleuchte; Stahl, chrom / Glas satiniert, weiss, klar
Applique/Plafonnier; acier, chrome / verre satiné, blanc, transparent

H 100, Ø 290



GU10



4x 2,8W



4x
250lm



9 002759 930851



93359 VILANOVA

system; aluminium, steel, aluminium, chrome
System; Alu, Stahl, alu, chrom
système; aluminium, acier, aluminium, chrome

L 2000, H 200



GU10



5x 2,8W



5x
250lm



9 002759 933593

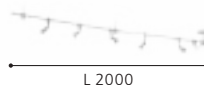

94609 VILANOVA

accessory; steel, satin nickel
Zubehör; Stahl, nickel-matt
Accessoires; acier, nickel mat

L 395



9 002759 946098





93358

LED

93358 VILANOVA

system; aluminium, steel, aluminium, chrome / glass, white, clear
 System; Alu, Stahl, alu, chrom / Glas, weiss, klar
 système; aluminium, acier, aluminium, chrome / verre, blanc, transparent

L 2000, H 200



GU10



5x 4,6W



5x
warm
WHITE
400lm



9 002759 933586



INCL.



L 2000

94609

Set to connect 93359 and 93358 tracks:
 › 250mm Kabel
 › 2 end parts
 › 1 straight connector for direct connection

Verbindungsset für 93359 und 93358 Schienen:
 › 250mm Kabel
 › 2 Endstücke
 › 1 Verbinder für eine direkte Verbindung

Set de connexion pour rails 93359 et 93358:
 › câble de 250mm
 › 2 pièces d'about
 › 1 connecteur pour une connexion directe





96182

LED



96178

LED



96179

LED

96182 CARDILLO 1

spot; aluminium, steel, aluminium, chrome / plastic, satin finish
Spot; Alu, Stahl, alu, chrom / Kunststoff, satiniert
spot; aluminium, acier, aluminium, chrome / plastique, satiné

L 985, B 85

LED warm WHITE LED warm WHITE

4x 3,2W 1760lm 2x 3,3W 800lm



9 002759 961824

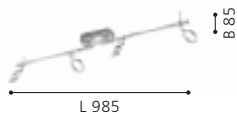

96178 CARDILLO 1

spot; aluminium, steel, aluminium, chrome / plastic, satin finish
Spot; Alu, Stahl, alu, chrom / Kunststoff, satiniert
spot; aluminium, acier, aluminium, chrome / plastique, satiné

L 225, B 65

LED warm WHITE LED warm WHITE

1x 3,2W 440lm 1x 2,2W 260lm



9 002759 961787



96179 CARDILLO 1

spot; aluminium, steel, aluminium, chrome / plastic, satin finish
Spot; Alu, Stahl, alu, chrom / Kunststoff, satiniert
spot; aluminium, acier, aluminium, chrome / plastique, satiné

L 390, B 85

LED warm WHITE LED warm WHITE

2x 3,2W 880lm 1x 3,3W 400lm



9 002759 961794

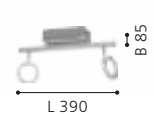



96181



96183



96181 CARDILLIO 1

spot; aluminium, steel, aluminium, chrome / plastic, satin finish
 Spot; Alu, Stahl, alu, chrom / Kunststoff, satiniert
 spot; aluminium, acier, aluminium, chrome / plastique, satiné

L 690, B 85



9 002759 961817

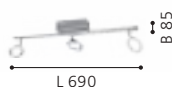

96183 CARDILLIO 1

spot; aluminium, steel, aluminium, chrome / plastic, satin finish
 Spot; Alu, Stahl, alu, chrom / Kunststoff, satiniert
 spot; aluminium, acier, aluminium, chrome / plastique, satiné

L 1585, B 85



9 002759 961831

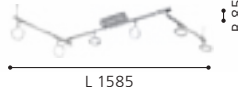

CARDILLIO 1

These luminaires have different lighting sources. Profil lights combined with spot heads create basic lighting as well as accent lighting.

Diese Leuchten verfügen über unterschiedliche Lichtquellen. Profilleuchten kombiniert mit Spotköpfen schaffen sowohl Grundlicht als auch Akzentbeleuchtung.

Ces luminaires ont des sources d'éclairage différentes. La combinaison entre un éclairage sur la base du produit et un spot vous permet d'avoir un éclairage général mais aussi directionnel.



900516

LED



900513

LED

900516 CARDILLIO 2

spot; aluminium, steel, black / plastic, satin finish
Spot; Alu, Stahl, schwarz / Kunststoff, satiniert
spot; aluminium, acier, noir / plastique, satiné

L 985, B 85, H 175



900513 CARDILLIO 2

spot; aluminium, steel, black / plastic, satin finish
Spot; Alu, Stahl, schwarz / Kunststoff, satiniert
spot; aluminium, acier, noir / plastique, satiné

L 225, B 65, H 165





900514 CARDILLIO 2

spot; aluminium, steel, black / plastic, satin finish
Spot; Alu, Stahl, schwarz / Kunststoff, satiniert
spot; aluminium, acier, noir / plastique, satiné

L 385, B 85, H 175



900515 CARDILLIO 2

spot; aluminium, steel, black / plastic, satin finish
Spot; Alu, Stahl, schwarz / Kunststoff, satiniert
spot; aluminium, acier, noir / plastique, satiné

L 385, B 85, H 175



900839 CARDILLIO 1

spot; aluminium, steel, black / plastic, satin finish
Spot; Alu, Stahl, schwarz / Kunststoff, satiniert
spot; aluminium, acier, noir / plastique, satiné

L 1585, B 85, H 200

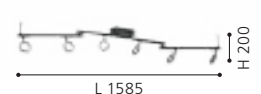



95629

LED



DESIGN
HIGHLIGHT
DETAIL

95629 SALTO

spot; steel, chrome / plastic, satin finish
Spot; Stahl, chrom / Kunststoff, satiniert
spot; acier, chrome / plastique, satiné

L 360, B 120

LED

2x 5,4W

warm
WHITE

2x
640lm



9 002759 956295



L 360

B 120



95631



95632



95631 SALTO

spot; steel, chrome / plastic, satin finish
 Spot; Stahl, chrom / Kunststoff, satiniert
 spot; acier, chrome / plastique, satiné

L 560, B 130



3x 5,4W

3x
640lm

95632 SALTO

spot; steel, chrome / plastic, satin finish
 Spot; Stahl, chrom / Kunststoff, satiniert
 spot; acier, chrome / plastique, satiné

L 760, B 130



4x 5,4W

4x
640lm



9 002759 956318

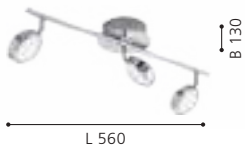

9 002759 956325





CLIP & PLUG LUMINAIRES

KLEMM- & STECKERLEUCHTEN
LUMINAIRES À PINCE & SUR PRISE



EN LIGHT - VIRTUALLY ANYWHERE

Our clamping and plug-in luminaires inspire with their flexible uses. They serve as pleasant reading lamps or can be positioned for targeted highlighting.

DE LICHT - PRAKTISCH ÜBERALL

Unsere Klemm- und Steckerleuchten begeistern durch ihre flexible Verwendbarkeit. Sie dienen als angenehme Lesebeleuchtung oder können zur gezielten Lichtsetzung positioniert werden.

FR LA LUMIÈRE - PRATIQUE ET PARTOUT

Nos luminaires à pinces et à fiches ravissent de leurs possibilités flexibles d'utilisation. Ils servent de lumière agréable pour la lecture ou peuvent être positionnés afin d'offrir une lumière ciblée.





OVERVIEW

CLIP & PLUG LUMINAIRES
KLEMM- & STECKERLEUCHTEN
LUMINAIRES À PINCE & SUR PRISE



CABADO
776



FABIO
776-777



RICCIO 1
777



MINI 4
778-779



DAKAR 3
778



This product is available in different colors and shapes. / Dieser Artikel ist in unterschiedlichen Farben und Formen verfügbar. /
Cet article est disponible en différentes couleurs et formes.





97077

LED



81262

97077 CABADO

clamp light; plastic, white
 Klemmleuchte; Kunststoff, weiss
 luminaire à pince; plastique, blanc

L 120, B 65, H 420



1,6W



150lm



Li-ion



500mAh



9 002759 970772



L 120

81262 FABIO

clamp light; steel, plastic, white, silver
 Klemmleuchte; Stahl, Kunststoff, weiss, silber
 luminaire à pince; acier, plastique, blanc, argent

H 300



E14



1x 40W



9 002759 812621



H 300



81265



94329

LED

81265 FABIO

clamp light; steel, plastic, silver
 Klemmleuchte; Stahl, Kunststoff, silber
 luminaire à pince; acier, plastique, argent

H 300



E14 1x 40W



9 002759 812652



H 300

94329 RICCIO 1

clamp light; plastic, steel, white, chrome / steel, white, chrome
 Klemmleuchte; Kunststoff, Stahl, weiss, chrom / Stahl, weiss, chrom
 luminaire à pince; plastique, acier, blanc, chrome / acier, blanc, chrome

L 180, H 330

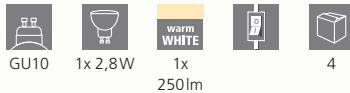

GU10 1x 2,8W 1x 250lm 4



9 002759 943295

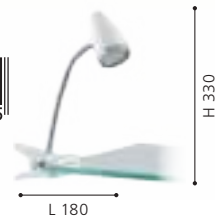

H 330

L 180



92924

LED



92925

LED



92935

92925 MINI 4

plug-in light; steel, white, chrome
Steckerleuchte; Stahl, weiss, chrom
luminaire sur prise; acier, blanc, chrome

L 70, H 100



GU10 1x 2,8W 1x 250lm



92924 MINI 4

plug-in light; steel, satin nickel, chrome
Steckerleuchte; Stahl, nickel-matt, chrom
luminaire sur prise; acier, nickel mat, chrome

L 70, H 100



GU10 1x 2,8W 1x 250lm



92935 DAKAR 3

plug-in light; steel, satin nickel, chrome / plastic, white
Steckerleuchte; Stahl, nickel-matt, chrom / Kunststoff, weiss
luminaire sur prise; acier, nickel mat, chrome / plastique, blanc

L 70, H 180, A 280



E14 1x 25W





92933

LED

92933 MINI 4

plug-in light; steel, satin nickel, chrome
Steckerleuchte; Stahl, nickel-matt, chrom
luminaire sur prise; acier, nickel mat, chrome

L 70, H 180, A 220



GU10



1x 2,8W



1x
warm
WHITE
250lm



4



9 002759 929336



INCL.





TABLE & FLOOR LUMINAIRES

TISCH- & STEHLEUCHTEN
LUMINAIRES DE TABLE & LAMPADAIRES

EN WE LOVE LIGHT

The range of table and floor luminaires is made up of many different styles and convinces with its diverse uses. The luminaires give your home a comfortable light mood and turn into chic living room accessories.

DE WIR STEHEN AUF LICHT

Das Sortiment der Tisch- und Stehleuchten setzt sich aus unterschiedlichen Stilen zusammen und überzeugt mit seinen vielseitigen Einsatzmöglichkeiten. Die Leuchten verleihen Ihrem Zuhause eine gemütliche Lichtstimmung und werden zum schicken Wohnraumaccessoire.

FR NOUS NOUS TENONS EN PLEINE LUMIÈRE



















































La gamme de luminaires de table et lampadaires est formée de différents styles et persuade par ses multiples possibilités d'application. Les lampes donnent à votre intérieur une lumière conviviale et se transforment en des accessoires d'habitat chics.





OVERVIEW

TABLE & FLOOR LUMINAIRES
TISCH- & STEHLEUCHTEN
LUMINAIRES DE TABLE & LAMPADAIRES

 PICCOLA 785	 MANNERA 786-787	 FONDACHELLI 788	 CONESA 790	 ESPARTAL 791	 NADINA 791	 ONEDA 792	 CORTADERAS 792
 ARANZOLA 793	 RONDO 4 794	 BELESER 795	 BUDENSEA 796	 CARBONERAS 796	 PICACHA 799	 BORGILLIO 799	 UP 2 800-801
 BAYA LED 802-803	 BAYA 804	 PASTERI 806	 CARLTON 2 807	 MANALBA 1 808	 MANALBA 808	 CHIETINO 1 809	 BELLARIVA 3 809
 TRONDIO 809	 BELLARIVA 810	 CAPALBIO 811	 CAHUAMA 812	 BATISTA 3 813	 TURALDO 1 813	 SWARBY 813	 MURNIA 814
 PETTO 1 814	 BILBANA 815	 BATABANO 815	 ERMUA 815	 SARONA 816	 AMEZAGA 816	 MARYVILLA 817	 CAPRAROLA 817
 CIUDADELA 817	 MADONNINA 818	 SOLO 2 819	 SOLO 1 820	 SOLO 821	 DAMASCO 1 821-822	 SLIM 821	 GEO 823
 NARANJO 825	 DESIERTO 825						



This product is available in different colors and shapes. / Dieser Artikel ist in unterschiedlichen Farben und Formen verfügbar. / Cet article est disponible en différentes couleurs et formes.



Office table & floor luminaires starts on page 826.
Office Tisch- & Stehleuchten starten auf Seite 826.
Luminaires de table & lampadaires à bureau commence à la page 826.





900923

LED

HIGH
IP

IP54



900924



900925



900923 PICCOLA

table light; steel, brushed brass / plastic, white
Tischleuchte; Stahl, messing-gebürstet / Kunststoff, weiss
luminaire de table; acier, laiton brossé / plastique, blanc

H 280, Ø 130, Base: Ø 70

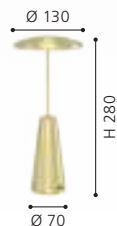
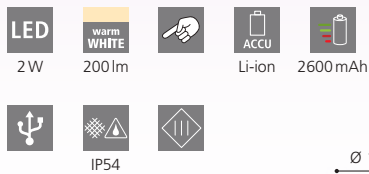

900924 PICCOLA

table light; steel, dark bronze / plastic, white
Tischleuchte; Stahl, bronze dunkel / Kunststoff, weiss
luminaire de table; acier, bronze foncé / plastique, blanc

H 280, Ø 130, Base: Ø 70

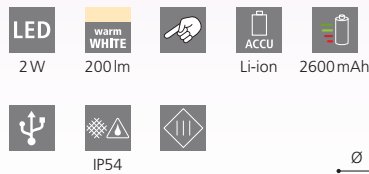

900925 PICCOLA

table light; steel, black / plastic, white
Tischleuchte; Stahl, schwarz / Kunststoff, weiss
luminaire de table; acier, noir / plastique, blanc

H 280, Ø 130, Base: Ø 70





900459



IP54



900457



IP54



900461



IP54

900459 MANNERA

table light; aluminium, steel, auburn / plastic, white
Tischleuchte; Alu, Stahl, rostbraun / Kunststoff, weiss
luminaire de table; aluminium, acier, brun rouille / plastique, blanc

H 340, Ø 110, Base: Ø 110



2,2W



200lm



Li-ion



1800mAh



IP54



9 008606 244003



900457 MANNERA

table light; aluminium, steel, black / plastic, white
Tischleuchte; Alu, Stahl, schwarz / Kunststoff, weiss
luminaire de table; aluminium, acier, noir / plastique, blanc

H 340, Ø 110, Base: Ø 110



2,2W



200lm



Li-ion



1800mAh



IP54



9 008606 243990



900461 MANNERA

table light; aluminium, steel, sandy / plastic, white
Tischleuchte; Alu, Stahl, sandfarben / Kunststoff, weiss
luminaire de table; aluminium, acier, couleur sable / plastique, blanc

H 340, Ø 110, Base: Ø 110



2,2W



200lm



Li-ion



1800mAh



IP54



9 008606 243983





900458

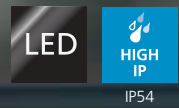

900458 MANNERA

table light; aluminium, steel, grey / plastic, white

Tischleuchte; Alu, Stahl, grau / Kunststoff, weiss

luminaire de table; aluminium, acier, gris / plastique, blanc

H 340, Ø 110, Base: Ø 110



2,2W



200lm



Li-ion



1800 mAh



IP54



9 008606 243976

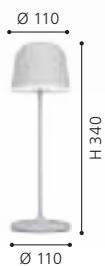



95539



95541

95539 FONDACHELLI

floor light; steel, satin nickel / fabric, white, silver
 Stehleuchte; Stahl, nickel-matt / Textil, weiss, silber
 lampadaire; acier, nickel mat / tissu, blanc, argent

H 1515, Ø 510

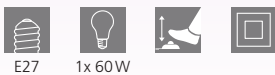

E27 1x 60W

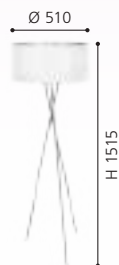

9 002759 955397

95541 FONDACHELLI

floor light; steel, black / fabric, black, copper
 Stehleuchte; Stahl, schwarz / Textil, schwarz, kupfer
 lampadaire; acier, noir / tissu, noir, cuivre

H 1515, Ø 510

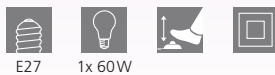

E27 1x 60W



9 002759 955410

900187 FONDACHELLI

floor light; steel, black / fabric, linen, grey
 Stehleuchte; Stahl, schwarz / Textil, Leinen, grau
 lampadaire; acier, noir / tissu, lin, gris

H 1515, Ø 510

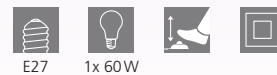

E27 1x 60W



9 008606 234479



900187



95686



98309

LED

95686 CONESA

floor light; steel, satin nickel / fabric, glass, white
 Stehleuchte; Stahl, nickel-matt / Textil, Glas, weiss
 lampadaire; acier, nickel mat / tissu, verre, blanc

H 1700, Ø 380, Base: Ø 230



E27



1x 60W



E14



1x 40W



9 002759 956868





92206



98309 ESPARTAL

floor light; steel, aluminium, satin nickel, aluminium / fabric, white

Stehleuchte; Stahl, Alu, nickel-matt, alu / Textil, weiss

lampadaire; acier, aluminium, nickel mat, aluminium / tissu, blanc

H 1485, Ø 250, Base: Ø 250



E27 1x 60W 11,8W 1650lm



9 002759 983093



92206 NADINA

floor light; steel, satin nickel / textile with velcro, white

Stehleuchte; Stahl, nickel-matt / Textil mit Klettverschluss, weiss

lampadaire; acier, nickel mat / tissu avec fermeture velcro, blanc

L 1790, B 380, H 1950, Base: Ø 320

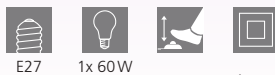

E27 1x 60W

L 1790



9 002759 922061





900393



900394



97806

LED

900393 ONEDA

table light; steel, black, white
Tischleuchte; Stahl, schwarz, weiss
luminaire de table; acier, noir, blanc

L 290, B 145, H 445, Base: Ø 210



E27 1x 40W



9 008606 243716



900394 ONEDA

floor light; steel, black, white
Stehleuchte; Stahl, schwarz, weiss
lampadaire; acier, noir, blanc

L 540, B 200, H 1605, Base: Ø 315



E27 1x 40W



9 008606 243723



97806 CORTADERAS

floor light; steel, black, gold
Stehleuchte; Stahl, schwarz, gold
lampadaire; acier, noir, or

H 1445, Ø 250, Base: Ø 250



GU10 2x 4,8W 2x warm WHITE 400lm



9 002759 978068



INCL.





900134



900135

900134 ARANZOLA

table light; steel, black, white
Tischleuchte; Stahl, schwarz, weiss
luminaire de table; acier, noir, blanc

H 450, Ø 300, Base: Ø 115



900135 ARANZOLA

floor light; steel, black, white
Stehleuchte; Stahl, schwarz, weiss
lampadaire; acier, noir, blanc

L 300, H 1635, Base: Ø 300

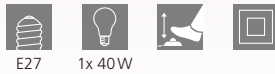

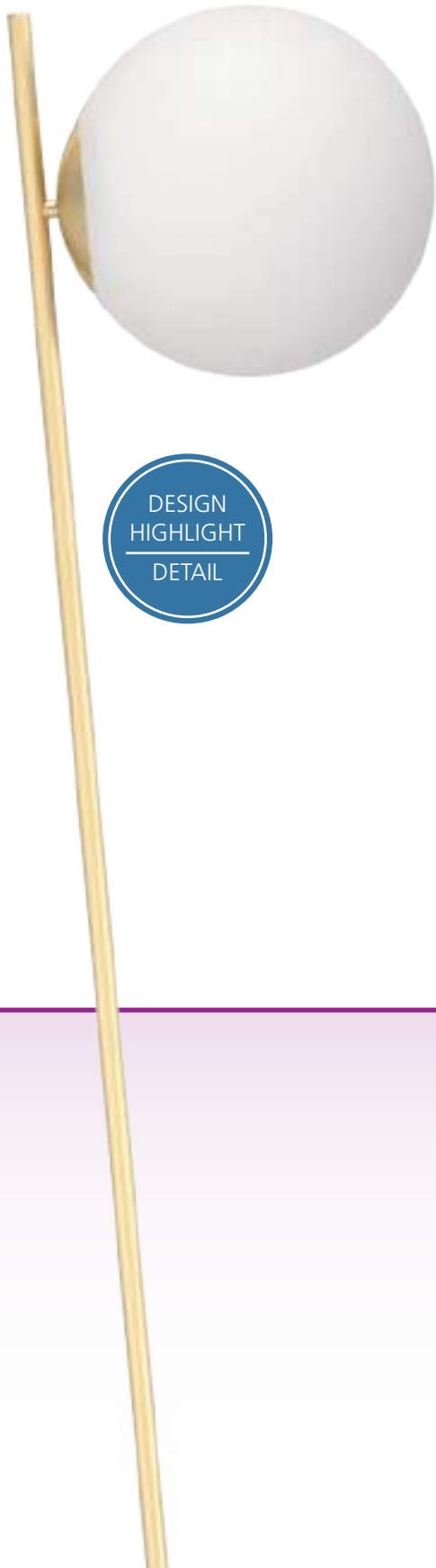

DESIGN
HIGHLIGHT
DETAIL



900868



RONDO 4

900869

900868 RONDO 4

table light; steel, brushed brass / matte-opal glass, white
Tischleuchte; Stahl, messing-gebürstet / Glas opal-matt, weiss
luminaire de table; acier, laiton brossé / verre opale mat, blanc

L 230, B 180, H 565, Base: Ø 215



900869 RONDO 4

floor light; steel, brushed brass / matte-opal glass, white
Stehleuchte; Stahl, messing-gebürstet / Glas opal-matt, weiss
lampadaire; acier, laiton brossé / verre opale mat, blanc

L 355, B 250, H 1745, Base: Ø 300





98386 BELESER

table light; steel, black / glass vaporized, black-transparent
Tischleuchte; Stahl, schwarz / Glas bedampft, schwarz-transparent
luminaire de table; acier, noir / verre vaporisé, noir transparent

L 265, B 205, H 505, Base: Ø 200

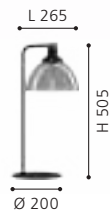
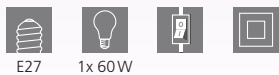

98387 BELESER

floor light; steel, black / glass vaporized, black-transparent
Stehleuchte; Stahl, schwarz / Glas bedampft, schwarz-transparent
lampadaire; acier, noir / verre vaporisé, noir transparent

L 260, B 205, H 1505, Base: Ø 220

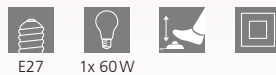



99113

These luminaires are rotatable.
 Diese Leuchten sind drehbar.
 Ces luminaires sont orientables.

0-180°

0-80°



99113

LED



99822

The heads of this luminaires can be switched and dimmed separately.
 Die Köpfe dieser Leuchten sind getrennt voneinander schaltbar und dimmbar.
 Les têtes de ce luminaires peuvent être commutées et gradées séparément.

99113 BUDENSEA

floor light; cast aluminium, black, white
 Stehleuchte; Aluguss, schwarz, weiss
 lampadaire; fonte d'aluminium, noir, blanc

L 365, B 250, H 1800, Base: B 300, T 250



GU10



2x 4,5W



2x
 warm
 WHITE
 345lm



9 002759 991135

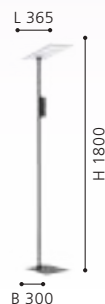

99822 CARBONERAS

floor light; steel, black / plastic, transparent
 Stehleuchte; Stahl, schwarz / Kunststoff, transparent
 lampadaire; acier, noir / plastique, transparent

L 400, B 250, H 1800, Base: B 330, T 240



6x 3,8W



warm
 WHITE
 2400lm



7W



warm
 WHITE
 750lm



9 002759 998226

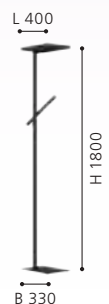



99822

LED



99715

LED

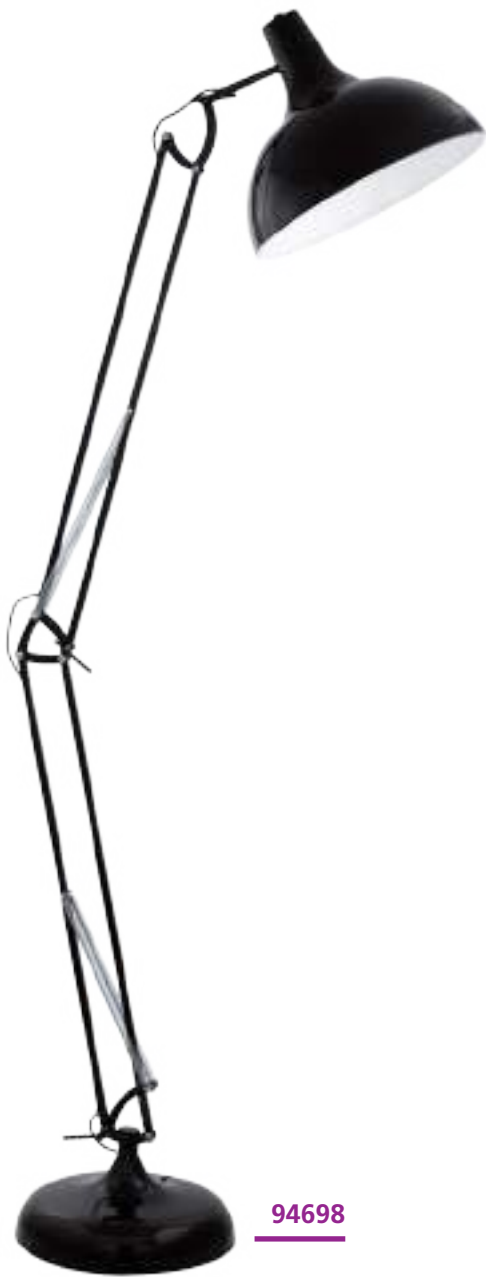

94698



94705

99715 PICACHA

floor light; steel, black / plastic, white
 Stehleuchte; Stahl, schwarz / Kunststoff, weiss
 lampadaire; acier, noir / plastique, blanc

H 1625, Base: B 150, T 150



29W 3500lm



9 002759 997151



94698 BORGILLO

floor light; steel, black
 Stehleuchte; Stahl, schwarz
 lampadaire; acier, noir

L 380, H 1900, Base: Ø 340

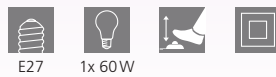

E27 1x 60W



9 002759 946982

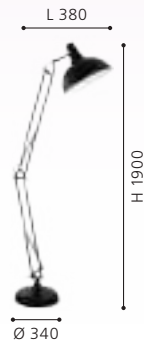

94705 BORGILLO

floor light; steel, copper
 Stehleuchte; Stahl, kupfer
 lampadaire; acier, cuivre

L 380, H 1900, Base: Ø 340

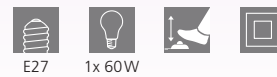

E27 1x 60W



9 002759 947057

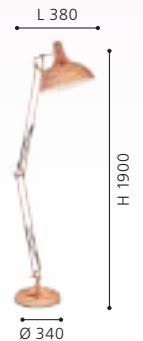



93917



82842



82843

93917 UP 2

floor light; steel, nickel-nero / plastic, glass, white
 Stehleuchte; Stahl, nickel-nero / Kunststoff, Glas, weiss
 lampadaire; acier, nickel noir / plastique, verre, blanc

H 1765, Ø 275, Base: Ø 230

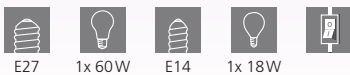

9 002759 939175



82842 UP 2

floor light; steel, satin nickel / plastic, glass, white
 Stehleuchte; Stahl, nickel-matt / Kunststoff, Glas, weiss
 lampadaire; acier, nickel mat / plastique, verre, blanc

H 1765, Ø 275, Base: Ø 230

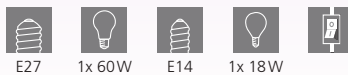

9 002759 828424



82843 UP 2

floor light; steel, matte brass / plastic, glass, white
 Stehleuchte; Stahl, messing-matt / Kunststoff, Glas, weiss
 lampadaire; acier, laiton mat / plastique, verre, blanc

H 1765, Ø 275, Base: Ø 230

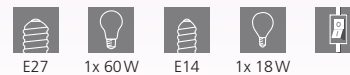

9 002759 828431





82844

DESIGN
HIGHLIGHT
DETAIL



82844 UP 2

floor light; steel, bronzed / plastic, glass, white
Stehleuchte; Stahl, brüniert / Kunststoff, Glas, weiss
lampadaire; acier, brun / plastique, verre, blanc

H 1765, Ø 275, Base: Ø 230

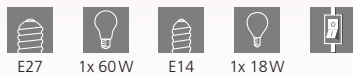

E27 1x 60W E14 1x 18W



9 002759 828448





93877



93876



93875



93877 BAYA LED

floor light; steel, brass / glass, plastic, white, satin finish
 Stehleuchte; Stahl, messing / Glas, Kunststoff, weiss, satiniert
 lampadaire; acier, laiton / verre, plastique, blanc, satiné

L 360, H 1800, Base: Ø 250

LED 20W warm WHITE 1950lm LED 2,5W warm WHITE 240lm LED 2,5W

warm WHITE 250lm



9 002759 938772



93876 BAYA LED

floor light; steel, bronzed / glass, plastic, white, satin finish
 Stehleuchte; Stahl, brüniert / Glas, Kunststoff, weiss, satiniert
 lampadaire; acier, brun / verre, plastique, blanc, satiné

L 360, H 1800, Base: Ø 250

LED 20W warm WHITE 1950lm LED 2,5W warm WHITE 240lm LED 2,5W

warm WHITE 250lm



9 002759 938765



93875 BAYA LED

floor light; steel, chrome / glass, plastic, white, satin finish
 Stehleuchte; Stahl, chrom / Glas, Kunststoff, weiss, satiniert
 lampadaire; acier, chrome / verre, plastique, blanc, satiné

L 360, H 1800, Base: Ø 250

LED 20W warm WHITE 1950lm LED 2,5W warm WHITE 240lm LED 2,5W

warm WHITE 250lm



9 002759 938758





DESIGN
HIGHLIGHT
DETAIL

93874 BAYA LED

floor light; steel, satin nickel / glass, plastic, white, satin finish
Stehleuchte; Stahl, nickel-matt / Glas, Kunststoff, weiss, satiniert
lampadaire; acier, nickel mat / verre, plastique, blanc, satiné

L 360, H 1800, Base: Ø 250

LED 20W	warm WHITE 2200lm	LED 2,5W	warm WHITE 250lm	LED 2,5W
-------------------	-----------------------------	--------------------	----------------------------	--------------------

warm WHITE 250lm				
----------------------------	--	--	--	--



9 002759 938741



93874

LED



DESIGN
HIGHLIGHT
DETAIL



85974

85974 BAYA

floor light; steel, bronzed / satin glass, white
Stehleuchte; Stahl, brüniert / Glas satiniert, weiss
lampadaire; acier, brun / verre satiné, blanc

L 440, H 1800, Base: Ø 280



R7S 1x 230W G9 1x 33W



9 002759 859749



85971 BAYA

floor light; steel, satin nickel / satin glass, white
Stehleuchte; Stahl, nickel-matt / Glas satiniert, weiss
lampadaire; acier, nickel mat / verre satiné, blanc

L 440, H 1800, Base: Ø 280



R7S 1x 230W G9 1x 33W



9 002759 859718





85971



95726



95725

95726 PASTERI

table light; steel, satin nickel / fabric, taupe
Tischleuchte; Stahl, nickel-matt / Textil, taupe
luminaire de table; acier, nickel mat / tissu, taupe

H 275, Ø 140, Base: Ø 120



E14 1x 40W



95725 PASTERI

table light; steel, satin nickel / fabric, white
Tischleuchte; Stahl, nickel-matt / Textil, weiss
luminaire de table; acier, nickel mat / tissu, blanc

H 275, Ø 140, Base: Ø 120



E14 1x 40W





95789



95787



95788

95789 CARLTON 2

table light; steel, black / fabric, white
Tischleuchte; Stahl, schwarz / Textil, weiss
luminaire de table; acier, noir / tissu, blanc

H 305, Ø 165, Base: Ø 95

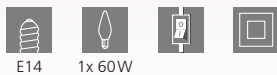

E14 1x 60W



9 002759 957896



95787 CARLTON 2

table light; steel, copper / fabric, black, copper
Tischleuchte; Stahl, kupfer / Textil, schwarz, kupfer
luminaire de table; acier, cuivre / tissu, noir, cuivre

H 305, Ø 165, Base: Ø 95



E14 1x 60W



9 002759 957872



95788 CARLTON 2

table light; steel, brass / fabric, black, gold
Tischleuchte; Stahl, messing / Textil, schwarz, gold
luminaire de table; acier, laiton / tissu, noir, or

H 305, Ø 165, Base: Ø 95



E14 1x 60W



9 002759 957889





99329



99331



95386

99329 MANALBA 1

table light; ceramic, silver / fabric, white, silver
Tischleuchte; Keramik, silber / Textil, weiss, silber
luminaire de table; céramique, argent / tissu, blanc, argent

H 300, Ø 200, Base: Ø 125



E14 1x 40W



9 002759 993290



99331 MANALBA 1

table light; ceramic, gold-coloured / fabric, black, gold
Tischleuchte; Keramik, goldfarben / Textil, schwarz, gold
luminaire de table; céramique, or / tissu, noir, or

H 300, Ø 200, Base: Ø 125



E14 1x 40W



9 002759 993313



95386 MANALBA

table light; steel, gold / fabric, black, gold
Tischleuchte; Stahl, gold / Textil, schwarz, gold
luminaire de table; acier, or / tissu, noir, or

H 380, Ø 250, Base: Ø 160

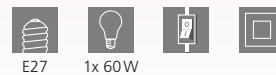

E27 1x 60W



9 002759 953867





97516



99332



93046

97516 CHIETINO 1

table light; wood, steel, natural, chrome / fabric, white
Tischleuchte; Holz, Stahl, natur, chrom / Textil, weiss
luminaire de table; bois, acier, naturel, chrome / tissu, blanc

H 440, Ø 260, Base: B 235, T 235

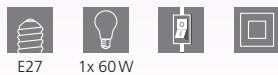

E27 1x 60W



9 002759 975166

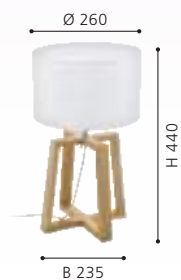

99332 BELLARIVA 3

table light; ceramic, white / fabric, linen, light brown
Tischleuchte; Keramik, weiss / Textil, Leinen, hellbraun
luminaire de table; céramique, blanc / tissu, lin, marron transparent

H 360, Ø 200, Base: Ø 160

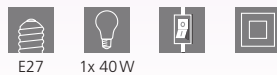

E27 1x 40W



9 002759 993320



93046 TRONDIO

table light; ceramic, white / fabric, white
Tischleuchte; Keramik, weiss / Textil, weiss
luminaire de table; céramique, blanc / tissu, blanc

H 270, Ø 150, Base: Ø 120

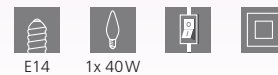

E14 1x 40W



9 002759 930462





97774



97773



97774 BELLARIVA

table light; ceramic, grey / fabric, white
Tischleuchte; Keramik, grau / Textil, weiss
luminaire de table; céramique, gris / tissu, blanc

H 320, Ø 150, Base: Ø 120



E14 1x 40W



97773 BELLARIVA

table light; ceramic, cream-white / fabric, white
Tischleuchte; Keramik, creme-weiss / Textil, weiss
luminaire de table; céramique, blanc crème / tissu, blanc

H 320, Ø 150, Base: Ø 120



E14 1x 40W





CAPALBIO



900824



900823

900824 CAPALBIO

table light; ceramic, grey / fabric, linen, natural
Tischleuchte; Keramik, grau / Textil, Leinen, natur
luminaire de table; céramique, gris / tissu, lin, nature

H 410, Ø 230, Base: Ø 120



E27 1x 40W



9 008606 274017



900823 CAPALBIO

table light; ceramic, sandy / fabric, white
Tischleuchte; Keramik, sandfarben / Textil, weiss
luminaire de table; céramique, couleur sable / tissu, blanc

H 410, Ø 230, Base: Ø 120

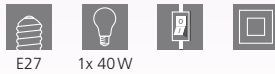

E27 1x 40W



9 008606 274000





99824



99825

99824 CAHUAMA

table light; ceramic, light brown / glass, white
Tischleuchte; Keramik, hellbraun / Glas, weiss
luminaire de table; céramique, marron clair / verre, blanc

H 300, Ø 275, Base: Ø 105



E27 1x 40W



9 002759 998240



99825 CAHUAMA

table light; ceramic, white, black / satin glass, grey matt
Tischleuchte; Keramik, weiss, schwarz / Glas satiniert, grau matt
luminaire de table; céramique, blanc, noir / verre satiné, gris mat

H 300, Ø 275, Base: Ø 105



E27 1x 40W



9 002759 998257





97589 BATISTA 3

table light; steel, satin nickel / glass wiping technique, white
Tischleuchte; Stahl, nickel-matt / Glas Wischtechnik, weiss
luminaire de table; acier, nickel mat / technique de verre essuyé, blanc

H 225, Ø 120, Base: Ø 110



900334 TURIALDO 1

table light; wood, steel, black
Tischleuchte; Holz, Stahl, schwarz
luminaire de table; bois, acier, noir

H 100, Ø 85

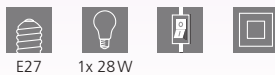

98859 SWARBY

table light; cement, grey
Tischleuchte; Zement, grau
luminaire de table; ciment, gris

H 120, Ø 100

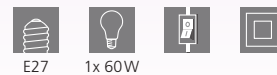



900314



94513

LED

DESIGN
HIGHLIGHT
DETAIL



900314 MURNIA

table light; steel, black, white
Tischleuchte; Stahl, schwarz, weiss
luminaire de table; acier, noir, blanc

L 190, B 165, H 430, Base: Ø 165



E14 1x 40W



9 008606 235421



94513 PETTO 1

table light; steel, white
Tischleuchte; Stahl, weiss
luminaire de table; acier, blanc

H 135, Ø 105, Base: Ø 90

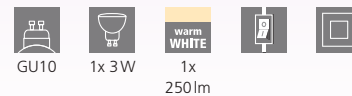

GU10 1x 3W 1x 250lm



9 002759 945138





900358



900396



98837



900358 BILBANA

table light; steel, black / matte-opal glass, white
Tischleuchte; Stahl, schwarz / Glas opal-matt, weiss
luminaire de table; acier, noir / verre opale mat, blanc

L 145, B 135, H 195, Base: B 135, T 115



E14 1x 40W



900396 BATABANO

table light; steel, sandy, black
Tischleuchte; Stahl, sandfarben, schwarz
luminaire de table; acier, couleur sable, noir

H 275, Ø 180, Base: Ø 160



E27 1x 40W



98837 ERMUA

table light; steel, wood, black, brown / plastic, white
Tischleuchte; Stahl, Holz, schwarz, braun / Kunststoff, weiss
luminaire de table; acier, bois, noir, marron / plastique, blanc

L 330, B 165, H 505, Base: B 240, T 160



LED warm WHITE 4,5W 480lm





900403

LED



98864

900403 SARONA

table light; steel, black, gold
Tischleuchte; Stahl, schwarz, gold
luminaire de table; acier, noir, or

H 315, Ø 140, Base: B 140



GU10



1x 4,5W



1x
345lm



9 008606 243785



98864 AMEZAGA

table light; steel, black, brass
Tischleuchte; Stahl, schwarz, messing
luminaire de table; acier, noir, laiton

L 355, B 160, H 575, Base: Ø 170



E27



1x 10W



9 002759 988647





900814

The shade colours of these luminaires look very different when switched on and off.

Die Schirmfarben dieser Leuchten sehen im ein- und ausgeschalteten Zustand sehr unterschiedlich aus.

Les couleurs de la teinte de ces luminaires sont très différentes lorsqu'ils sont allumés et éteints.



900552



900814



900898

900552 MARYVILLA

table light; steel, bronzed / glass vaporized, clear, gold
Tischleuchte; Stahl, brüniert / Glas bedampft, klar, gold
luminaire de table; acier, brun / verre vaporisé, transparent, or

H 230, Ø 170, Base: Ø 130



E27 1x 40W



9 008606 244577

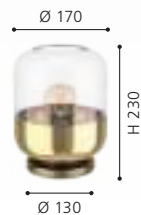

900814 CAPRAROLA

table light; steel, brushed brass / satin glass, sandy
Tischleuchte; Stahl, messing-gebürstet / Glas satiniert, sandfarben
luminaire de table; acier, laiton brossé / verre satiné, couleur sable

H 460, Ø 200, Base: Ø 155

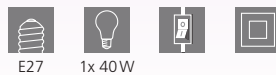

E27 1x 40W



9 008606 274345



900898 CIUADELA

table light; steel, black / steel, fabric, brushed brass, white
Tischleuchte; Stahl, schwarz / Stahl, Textil, messing-gebürstet, weiss
luminaire de table; acier, noir / acier, tissu, laiton brossé, blanc

L 230, B 180, H 500, Base: Ø 170

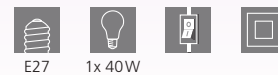

E27 1x 40W



9 008606 274697





900945



900946



DESIGN
HIGHLIGHT
DETAIL

900945 MADONNINA

table light; steel, black / glass vaporized, grey
Tischleuchte; Stahl, schwarz / Glas bedampft, grau
luminaire de table; acier, noir / verre vaporisé, gris

H 270, Ø 330, Base: Ø 150



E27 1x 40W



9 008606 274963



900946 MADONNINA

table light; steel, black / glass vaporized, grey
Tischleuchte; Stahl, schwarz / Glas bedampft, grau
luminaire de table; acier, noir / verre vaporisé, gris

H 325, Ø 250, Base: Ø 130



E27 1x 40W



9 008606 274970





900141



900142

900141 SOLO 2

table light; steel, black / glass vaporized, black-transparent
Tischleuchte; Stahl, schwarz / Glas bedampft, schwarz-transparent
luminaire de table; acier, noir / verre vaporisé, noir transparent

H 415, Ø 260, Base: Ø 180



E27 1x 40W



9 008606 235346



900142 SOLO 2

table light; steel, black / etched glass, white
Tischleuchte; Stahl, schwarz / Glas geätzt, weiss
luminaire de table; acier, noir / verre gravé, blanc

H 415, Ø 260, Base: Ø 180



E27 1x 40W



9 008606 235353





87254



87256



85104

87254 SOLO 1

table light; steel, matte brass / satin glass, white
Tischleuchte; Stahl, messing-matt / Glas satiniert, weiss
luminaire de table; acier, laiton mat / verre satiné, blanc

H 350, Ø 260, Base: Ø 130



E14 1x 40W



9 002759 872540



87256 SOLO 1

table light; steel, wood, bronzed, nut / satin glass, white
Tischleuchte; Stahl, Holz, brüniert, Nuss / Glas satiniert, weiss
luminaire de table; acier, bois, brun, noisette / verre satiné, blanc

H 350, Ø 260, Base: Ø 130

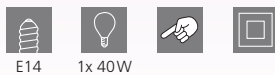

E14 1x 40W



9 002759 872564



85104 SOLO 1

table light; steel, satin nickel / satin glass, white
Tischleuchte; Stahl, nickel-matt / Glas satiniert, weiss
luminaire de table; acier, nickel mat / verre satiné, blanc

H 350, Ø 260, Base: Ø 130

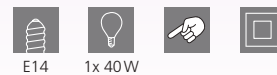

E14 1x 40W



9 002759 851040





91238



95785



95785



82305



82305

91238 SOLO

table light; steel, satin nickel / satin glass, white with decoration
Tischleuchte; Stahl, nickel-matt / Glas satiniert, weiss m. Dekor
luminaire de table; acier, nickel mat / verre satiné, blanc avec décor

H 320, Ø 265, Base: Ø 130

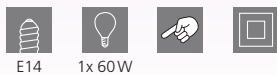

E14 1x 60W



9 002759 912383



95785 DAMASCO 1

table light; steel, satin nickel / matte-opal glass, white
Tischleuchte; Stahl, nickel-matt / Glas opal-matt, weiss
luminaire de table; acier, nickel mat / verre opale mat, blanc

H 300, Ø 145, Base: Ø 120



E14 1x 60W



9 002759 957858



82305 SLIM

table light; steel, satin nickel / glass, white
Tischleuchte; Stahl, nickel-matt / Glas, weiss
luminaire de table; acier, nickel mat / verre, blanc

H 220, Ø 70, Base: Ø 100

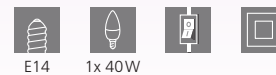

E14 1x 40W



9 002759 823054





81828 | 95775 | 95776



95775



95776



98887

95775 DAMASCO 1

table light; steel, satin nickel / satin glass, white
Tischleuchte; Stahl, nickel-matt / Glas satiniert, weiss
luminaire de table; acier, nickel mat / verre satiné, blanc

H 215, Ø 100



E27 1x 60W



9 002759 957759



95776 DAMASCO 1

table light; steel, chrome / satin glass, white
Tischleuchte; Stahl, chrom / Glas satiniert, weiss
luminaire de table; acier, chrome / verre satiné, blanc

H 215, Ø 100



E27 1x 60W



9 002759 957766



98887 DAMASCO 1

table light; steel, black / glass vaporized, black-transparent
Tischleuchte; Stahl, schwarz / Glas bedampft, schwarz-transparent
luminaire de table; acier, noir / verre vaporisé, noir transparent

H 310, Ø 100



E27 1x 60W



9 002759 988876





81827 | 91242



81827



81828



91242

81827 GEO

table light; glass, plastic, white
Tischleuchte; Glas, Kunststoff, weiss
luminaire de table; verre, plastique, blanc

H 200, Ø 100, Base: Ø 100

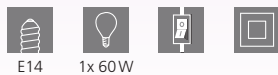

E14 1x 60W



9 002759 818272



81828 GEO

table light; matte-opal glass, white
Tischleuchte; Glas opal-matt, weiss
luminaire de table; verre opale mat, blanc

H 350, Ø 120, Base: Ø 120



E27 1x 60W



9 002759 818289



91242 GEO

table light; glass, plastic, white
Tischleuchte; Glas, Kunststoff, weiss
luminaire de table; verre, plastique, blanc

H 200, Ø 100



E14 1x 60W



9 002759 912420





99597

LED

DESIGN
HIGHLIGHT
DETAIL



99794



99597 NARANJO

table light; steel, black / glass, clear
Tischleuchte; Stahl, schwarz / Glas, klar
luminaire de table; acier, noir / verre, transparent

L 450, B 430, H 555



4x 4,5W 2200lm



9 002759 995973



99794 DESIERTO

table light; steel, wood, black, brown
Tischleuchte; Stahl, Holz, schwarz, braun
luminaire de table; acier, bois, noir, marron

H 540, Ø 450, Base: Ø 330

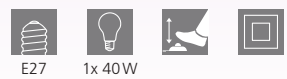

E27 1x 40W



9 002759 997946





OFFICE TABLE & FLOOR LUMINAIRES

OFFICE TISCH- & STEHLEUCHTEN
LUMINAIRES DE TABLE & LAMPADAIRES À BUREAU



EN WE LOVE LIGHT

The range of office table and floor luminaires is made up of many different styles and convinces with its diverse uses.

DE WIR STEHEN AUF LICHT

Das Sortiment der Büro Tisch- und Stehleuchten setzt sich aus unterschiedlichen Stilen zusammen und überzeugt mit seinen vielseitigen Einsatzmöglichkeiten.

FR NOUS NOUS TENONS EN PLEINE LUMIÈRE

La gamme d'éclairages de table et sur pieds à bureau est formée de différents styles et persuade par ses multiples possibilités d'application.





OVERVIEW

OFFICE TABLE & FLOOR LUMINAIRES
OFFICE TISCH- & STEHLEUCHTEN
LUMINAIRES DE TABLE & LAMPADAIRES À BUREAU

 TRUNCA 830	 MASSERIE 830	 ARENAZA 831	 BANDERALO 832	 LACEY-QI 833	 VERADAL-QI 833	 INIESTA 834	 SELLANO 836
 LA SECA 837	 CAUPO 838	 BROLINI 839	 COGNOLI 840	 LAROJA 842-843	 VERADAL 844	 CEPPINO 844-845	 DURENGO 846
 DAMBERA 846	 SNAPORA 846	 GEXO 848	 CABALES 848-849	 CAJERO 850-851	 CABADO 1 851	 TORONA 1 852	 TABILLANO 1 852
 BORGILLIO 854-855	 BANKER 856	 FIRMO 857	 BASIC 1 858	 BASIC 858-859	 FOX 860		



This product is available in different colors and shapes. / Dieser Artikel ist in unterschiedlichen Farben und Formen verfügbar. / Cet article est disponible en différentes couleurs et formes.



98093, 98247, 99828, 99829

These luminaires have a Qi charging function. They can wirelessly charge Qi-compatible Smartphones by inductive energy transfer.

Diese Leuchten besitzen eine Qi-Ladefunktion. Damit können Qi-kompatible Smartphones über induktive Energieübertragung kabellos geladen werden.

Ces luminaires disposent d'une fonction de chargement Qi. Cela permet aux smartphones compatibles Qi d'être chargés sans fil par transmission d'énergie inductive.



98093

LED



98247

LED

98093 TRUNCA

table light; plastic, white

Tischleuchte; Kunststoff, weiss

luminaire de table; plastique, blanc

H 485, Base: B 185, T 185

LED

4W

tunable
WHITE

450lm



9 002759 980931



98247 MASSERIE

table light; plastic, white

Tischleuchte; Kunststoff, weiss

luminaire de table; plastique, blanc

H 385, Base: B 165, T 165

LED

3,4W

neutral
WHITE

460lm



9 002759 982478





99828 ARENAZA

table light; steel, plastic, white, black
 Tischleuchte; Stahl, Kunststoff, weiss, schwarz
 luminaire de table; acier, plastique, blanc, noir

L 240, B 130, H 320, Base: B 240, T 120

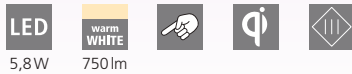

99829 ARENAZA

table light; steel, plastic, black
 Tischleuchte; Stahl, Kunststoff, schwarz
 luminaire de table; acier, plastique, noir

L 240, B 130, H 320, Base: B 240, T 120





DESIGN
HIGHLIGHT
DETAIL

99831 BANDERALO

table light; plastic, white

Tischleuchte; Kunststoff, weiss

luminaire de table; plastique, blanc

L 305, B 170, H 405, Base: Ø 170

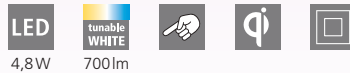

99832 BANDERALO

table light; plastic, black

Tischleuchte; Kunststoff, schwarz

luminaire de table; plastique, noir

L 305, B 170, H 405, Base: Ø 170

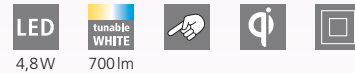



900626



900628



900626 LACEY-QI

table light; steel, wood, black, brown / steel, black, creme
 Tischleuchte; Stahl, Holz, schwarz, braun / Stahl, schwarz, creme
 luminaire de table; acier, bois, noir, marron / acier, noir, crème

L 240, B 135, H 500, Base: B 190, T 130

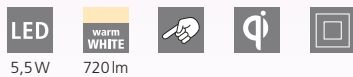

900628 VERADAL-QI

table light; steel, wood, black, brown / steel, black, creme
 Tischleuchte; Stahl, Holz, schwarz, braun / Stahl, schwarz, creme
 luminaire de table; acier, bois, noir, marron / acier, noir, crème

L 215, B 160, H 450, Base: Ø 160

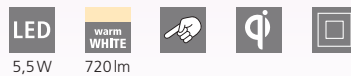



900956

LED



900958

LED



INIESTA

The luminaire arm can be swivelled 180°.

Der Leuchtenarm ist 180° schwenkbar.

Le bras du luminaire peut pivoter de 180°.

INIESTA

These luminaires have a USB port for charging and operating the luminaires.

Diese Leuchten verfügen über einen USB-Anschluss, der zum Laden und Betrieb der Leuchten dient.

Faites fonctionner et charger ces luminaires grâce au port USB.

900956 INIESTA

table light; plastic, white, black / plastic, white
Tischleuchte; Kunststoff, weiss, schwarz / Kunststoff, weiss
luminaire de table; plastique, blanc, noir / plastique, blanc

L 330, B 35, H 350, Base: B 160, T 115

LED 3,6W tunable WHITE ACCU 1800mAh

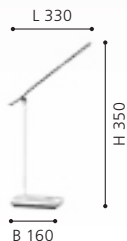

900958 INIESTA

table light; plastic, black / plastic, cappuccino, white
Tischleuchte; Kunststoff, schwarz / Kunststoff, cappuccino, weiss
luminaire de table; plastique, noir / plastique, cappuccino, blanc

L 330, B 35, H 350, Base: B 160, T 115

LED 3,6W tunable WHITE ACCU 1800mAh



900957 INIESTA

table light; plastic, grey, black / plastic, white
Tischleuchte; Kunststoff, grau, schwarz / Kunststoff, weiss
luminaire de table; plastique, gris, noir / plastique, blanc

L 330, B 35, H 350, Base: B 160, T 115

LED 3,6W tunable WHITE ACCU 1800mAh

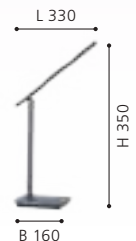



900957

LED



93901

LED

93901

The touch buttons can be used to dim the luminaires and adjust the light colour.

Über die Berührungsschalter kann man die Leuchten dimmen und die Lichtfarbe einstellen.

Les interrupteurs tactiles permettent de faire varier l'intensité des luminaires et de régler la couleur de la lumière.

93901 SELLANO

table light; plastic, steel, white, black
Tischleuchte; Kunststoff, Stahl, weiss, schwarz
luminaire de table; plastique, acier, blanc, noir

L 360, H 420, Base: B 180, T 180



4W



450lm



9 002759 939014

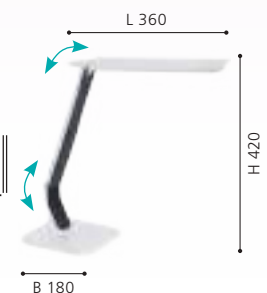



LA SECA

These luminaires have a USB port for charging and operating the luminaires.

Diese Leuchten verfügen über einen USB-Anschluss, der zum Laden und Betrieb der Leuchten dient.

Faites fonctionner et charger ces luminaires grâce au port USB.



97044

LED



97045

LED

97044 LA SECA

table light; plastic, white
Tischleuchte; Kunststoff, weiss
luminaire de table; plastique, blanc

L 200, B 50, H 260, Base: B 70, T 50

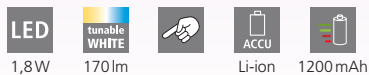

9 002759 970444

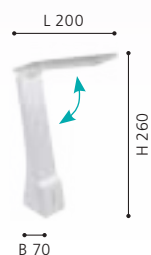

97045 LA SECA

table light; plastic, black
Tischleuchte; Kunststoff, schwarz
luminaire de table; plastique, noir

L 200, B 50, H 260, Base: B 70, T 50

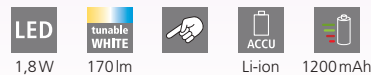

9 002759 970451



DESIGN
HIGHLIGHT
DETAIL



93966



93965



93966 CAUPO

table light; plastic, steel, black
Tischleuchte; Kunststoff, Stahl, schwarz
luminaire de table; plastique, acier, noir

L 260, H 320, Base: B 150, T 150

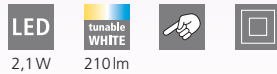

9 002759 939663



93965 CAUPO

table light; plastic, steel, white
Tischleuchte; Kunststoff, Stahl, weiss
luminaire de table; plastique, acier, blanc

L 260, H 320, Base: B 150, T 150



9 002759 939656

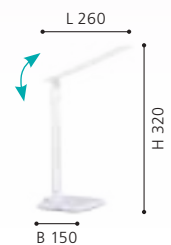



900529

LED



900528

LED

900529 BROLINI

table light; plastic, white
Tischleuchte; Kunststoff, weiss
luminaire de table; plastique, blanc

H 550, Ø 150, Base: Ø 150



2,1W



300lm



Li-ion



1500mAh



9 008606 242832



900528 BROLINI

table light; plastic, black
Tischleuchte; Kunststoff, schwarz
luminaire de table; plastique, noir

H 550, Ø 150, Base: Ø 150



2,1W



300lm



Li-ion



1500mAh



9 008606 242825





DESIGN
HIGHLIGHT
DETAIL



97915

LED

97915 COGNOLI

table light; plastic, white
Tischleuchte; Kunststoff, weiss
luminaire de table; plastique, blanc

L 70, B 100, H 510, Base: B 100, T 70

LED

4,4W

neutral
WHITE

430lm



9 002759 979157

97914 COGNOLI

table light; plastic, black
Tischleuchte; Kunststoff, schwarz
luminaire de table; plastique, noir

L 70, B 100, H 510, Base: B 100, T 70

LED

4,4W

neutral
WHITE

430lm



9 002759 979140



97914

LED



96435

LED



96434

LED



96438

LED

96435 LAROA

table light; plastic, white
Tischleuchte; Kunststoff, weiss
luminaire de table; plastique, blanc

L 480, B 120, H 325, Base: B 170, T 120

LED

neutral
WHITE



4,2W

600lm



9 002759 964351



96434 LAROA

clamp light; plastic, white
Klemmleuchte; Kunststoff, weiss
luminaire à pince; plastique, blanc

L 450, B 65, H 275

LED

neutral
WHITE



4,2W

600lm



9 002759 964344

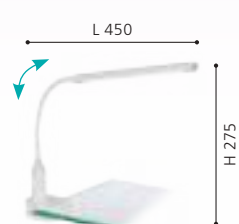

96438 LAROA

table light; plastic, black
Tischleuchte; Kunststoff, schwarz
luminaire de table; plastique, noir

L 480, B 120, H 325, Base: B 170, T 120

LED

neutral
WHITE



4,2W

600lm



9 002759 964382





96437

LED



96439

LED



96436

LED

96437 LAROA

clamp light; plastic, black
Klemmleuchte; Kunststoff, schwarz
luminaire à pince; plastique, noir

L 450, B 65, H 275



4,2W 600lm



9 002759 964375



96439 LAROA

floor light; plastic, black
Stehleuchte; Kunststoff, schwarz
lampadaire; plastique, noir

L 535, B 215, H 1300, Base: Ø 210



4,2W 600lm



9 002759 964399



96436 LAROA

floor light; plastic, white
Stehleuchte; Kunststoff, weiss
lampadaire; plastique, blanc

L 535, B 215, H 1300, Base: Ø 210



4,2W 600lm



9 002759 964368





98831



98832

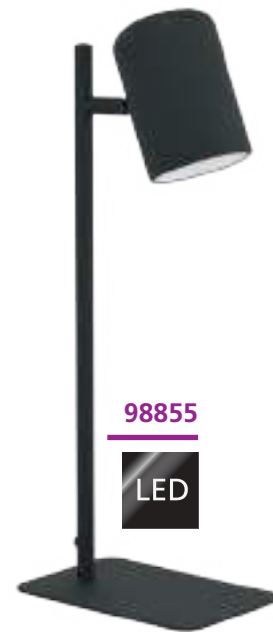

98855



98831 VERADAL

table light; wood, plastic, black, brown / steel, black
Tischleuchte; Holz, Kunststoff, schwarz, braun / Stahl, schwarz
luminaire de table; bois, plastique, noir, marron / acier, noir

B 125, H 490, Base: Ø 160



E27 1x 40W



9 002759 988319



98832 VERADAL

table light; wood, plastic, white, brown / steel, white
Tischleuchte; Holz, Kunststoff, weiss, braun / Stahl, weiss
luminaire de table; bois, plastique, blanc, marron / acier, blanc

B 125, H 490, Base: Ø 160



E27 1x 40W



9 002759 988326



98855 CEPPINO

table light; steel, black, white
Tischleuchte; Stahl, schwarz, weiss
luminaire de table; acier, noir, blanc

H 380, Base: B 165, T 110

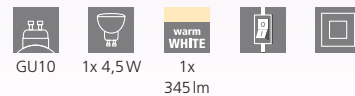

GU10 1x 4,5W 1x 345lm



9 002759 988555





98856



98856 CEPPINO

table light; steel, white
Tischleuchte; Stahl, weiss
luminaire de table; acier, blanc

H 380, Base: B 165, T 110



GU10



1x 4,5W



1x
warm
WHITE
345 lm



9 002759 988562





93078

LED



94673

LED

93078 DURENGO

table light; plastic, steel, white, chrome
Tischleuchte; Kunststoff, Stahl, weiss, chrom
luminaire de table; plastique, acier, blanc, chrome

H 380, Ø 160, Base: Ø 160



2,5W 250lm



9 002759 930783

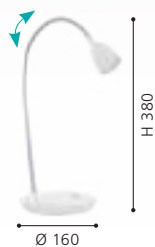

94673 DAMBERA

table light; plastic, black
Tischleuchte; Kunststoff, schwarz
luminaire de table; plastique, noir

H 375, Base: Ø 170



4,5W 660lm



9 002759 946739



94677 SNAPORA

table light; plastic, aluminium, black
Tischleuchte; Kunststoff, Alu, schwarz
luminaire de table; plastique, aluminium, noir

H 485, Base: Ø 110



3W 300lm



9 002759 946777





94677

LED



93076

LED



93077

LED



99334

LED

93076 GEXO

table light; plastic, steel, black, chrome
Tischleuchte; Kunststoff, Stahl, schwarz, chrom
luminaire de table; plastique, acier, noir, chrome

H 320, Ø 125, Base: Ø 125

LED

warm
WHITE



2,5W

230lm



9 002759 930769

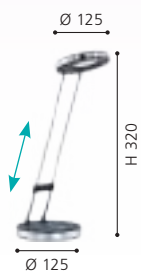

93077 GEXO

table light; plastic, steel, white, chrome
Tischleuchte; Kunststoff, Stahl, weiss, chrom
luminaire de table; plastique, acier, blanc, chrome

H 320, Ø 125, Base: Ø 125

LED

warm
WHITE



2,5W

230lm



9 002759 930776

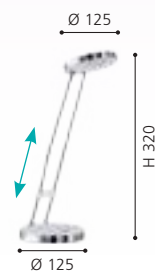

99334 CABALES

table light; plastic, white
Tischleuchte; Kunststoff, weiss
luminaire de table; plastique, blanc

H 340, Ø 140, Base: Ø 140

LED

warm
WHITE



4,6W

490lm



9 002759 993344

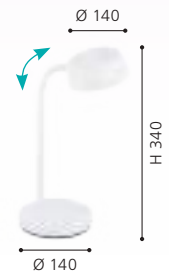



99335

LED

99335 CBALES

table light; plastic, black
Tischleuchte; Kunststoff, schwarz
luminaire de table; plastique, noir

H 340, Ø 140, Base: Ø 140

LED

4,6W

warm
WHITE

490lm



9 002759 993351





95694

LED



97078

These luminaires have a colored light in the base.

Diese Leuchten verfügen über ein farbiges Licht im Sockel.

Ces luminaires disposent d'une lumière colorée dans le socle.

95694 CAJERO

table light; plastic, silver

Tischleuchte; Kunststoff, silber

luminaire de table; plastique, argent

L 150, B 100, H 500, Base: B 155, T 100

LED

4,5W

neutral
WHITE

687lm



9 002759 956943

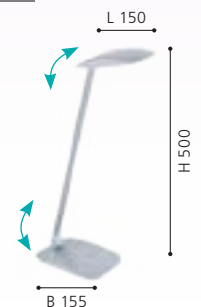



95696

LED



95695

LED



97078

LED

95696 CAJERO

table light; plastic, black
Tischleuchte; Kunststoff, schwarz
luminaire de table; plastique, noir

L 150, B 100, H 500, Base: B 155, T 100



4,5W 687lm



9 002759 956967

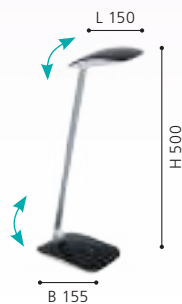

95695 CAJERO

table light; plastic, white
Tischleuchte; Kunststoff, weiss
luminaire de table; plastique, blanc

L 150, B 100, H 500, Base: B 155, T 100



4,5W 687lm



9 002759 956950



97078 CABADO 1

table light; plastic, white
Tischleuchte; Kunststoff, weiss
luminaire de table; plastique, blanc

L 140, B 110, H 490, Base: B 130, T 105



2,4W 300lm 0,3W 20lm



9 002759 970789





96957

DESIGN
HIGHLIGHT
DETAIL

96957 TORONA 1

table light; steel, white / wood, natural
Tischleuchte; Stahl, weiss / Holz, natur
luminaire de table; acier, blanc / bois, nature

L 445, B 180, H 605, Base: Ø 180



E14 1x 28W



9 002759 969578



99019 TABILLANO 1

table light; steel, black
Tischleuchte; Stahl, schwarz
luminaire de table; acier, noir

L 560, B 180, H 475, Base: Ø 180



E27 1x 40W



9 002759 990190





99019



94699



94702

DESIGN
HIGHLIGHT
DETAIL



94699 BORGILLIO

table light; steel, white
Tischleuchte; Stahl, weiss
luminaire de table; acier, blanc

L 400, B 190, H 710, Base: Ø 190



E27 1x 40W

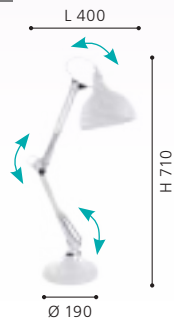

9 002759 946999

94702 BORGILLIO

table light; steel, chrome
Tischleuchte; Stahl, chrom
luminaire de table; acier, chrome

L 400, B 190, H 710, Base: Ø 190



E27 1x 40W



9 002759 947026



94697



94704

94697 BORGILLIO

table light; steel, black
Tischleuchte; Stahl, schwarz
luminaire de table; acier, noir

L 400, B 190, H 710, Base: Ø 190



E27 1x 40W



9 002759 946975

94704 BORGILLIO

table light; steel, copper
Tischleuchte; Stahl, kupfer
luminaire de table; acier, cuivre

L 400, B 190, H 710, Base: Ø 190



E27 1x 40W

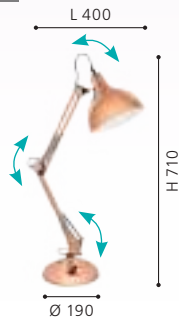

9 002759 947040



90967



DESIGN
HIGHLIGHT
DETAIL

90967 BAKER

table light; steel, brass / painted glass, green
Tischleuchte; Stahl, messing / Glas lackiert, grün
luminaire de table; acier, laiton / verre laqué, marron granit

L 275, H 390



E27



1x 60W



9 002759 909673



FIRMO

These luminaires come with a clip.

Diese Leuchten sind mit einer Klemme ausgestattet.

Ces luminaires viennent avec une pince fixation.



90872



90873



90874

90872 FIRMO

table light; steel, plastic, shiny white

Tischleuchte; Stahl, Kunststoff, weiss glänzend

luminaire de table; acier, plastique, blanc brillant

L 730



E27



1x 40W



9 002759 908720

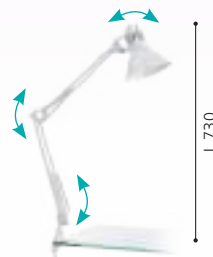

90873 FIRMO

table light; steel, plastic, shiny black

Tischleuchte; Stahl, Kunststoff, schwarz glänzend

luminaire de table; acier, plastique, noir brillant

L 730



E27



1x 40W



9 002759 908737



90874 FIRMO

table light; steel, plastic, silver

Tischleuchte; Stahl, Kunststoff, silber

luminaire de table; acier, plastique, argent

L 730



E27



1x 40W



9 002759 908744

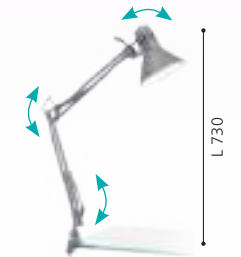



90977



9228



9229

90977 BASIC 1

table light; plastic, steel, silver
Tischleuchte; Kunststoff, Stahl, silber
luminaire de table; plastique, acier, argent

H 300, Base: Ø 125



E27 1x 40W



9 002759 909772



9228 BASIC

table light; plastic, steel, black
Tischleuchte; Kunststoff, Stahl, schwarz
luminaire de table; plastique, acier, noir

H 300, Base: Ø 125

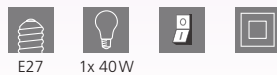

E27 1x 40W



9 002759 922801



9229 BASIC

table light; plastic, steel, white
Tischleuchte; Kunststoff, Stahl, weiss
luminaire de table; plastique, acier, blanc

H 300, Base: Ø 125

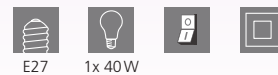

E27 1x 40W



9 002759 922900





9230



9232

9230 BASIC

table light; plastic, steel, red
Tischleuchte; Kunststoff, Stahl, rot
luminaire de table; plastique, acier, rouge

H 300, Base: Ø 125



E27 1x 40W



9 002759 923006



9232 BASIC

table light; plastic, steel, blue
Tischleuchte; Kunststoff, Stahl, blau
luminaire de table; plastique, acier, bleu

H 300, Base: Ø 125

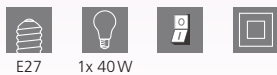

E27 1x 40W



9 002759 923204





DESIGN
HIGHLIGHT
DETAIL







92872

LED

92872 FOX

table light; steel, white, chrome
Tischleuchte; Stahl, weiss, chrom
luminaire de table; acier, blanc, chrome

H 320, Base: Ø 125

-  GU10
-  1x 2,8W
-  warm WHITE
1x 250lm
- 
- 







9 002759 928728



92873 FOX

table light; steel, anthracite, chrome
Tischleuchte; Stahl, anthrazit, chrom
luminaire de table; acier, gris anthracite, chrome

H 320, Base: Ø 125

-  GU10
-  1x 2,8W
-  warm WHITE
1x 250lm
- 
- 



9 002759 928735





92873

LED



CHILDREN LUMINAIRES

KINDERLEUCHTEN
LUMINAIRES POUR ENFANTS



EN **PLAY OF COLOUR**

The nursery luminaires are characterised by their playful and child-friendly designs. The lovely motives light up in many different colours and turn the nursery into a very special location.

DE **FARBENSPIEL**

Die Kinderzimmerleuchten zeichnen sich durch ihr verspieltes und kindgerechtes Design aus. Die liebevollen Motive erleuchten in unterschiedlichsten Farben und machen das Kinderzimmer zu einem besonderen Ort.

FR **JEU DE COULEUR**

Les éclairages de chambres d'enfants se distinguent de leur design joueur et adapté aux enfants. Les sujets formés avec amour sont illuminés dans des couleurs les plus variées et font de la chambre d'enfant un endroit spécial.





OVERVIEW

CHILDREN LUMINAIRES
KINDERLEUCHTEN
LUMINAIRES POUR ENFANTS



JUNIOR 1
866



TABARA
867



VIKI 1
867



This product is available in different colors and shapes. / Dieser Artikel ist in unterschiedlichen Farben und Formen verfügbar. /
Cet article est disponible en différentes couleurs et formes.





87284



87284 JUNIOR 1

wall/ceiling light; steel, white / satin glass, football motif

Wand- / Deckenleuchte; Stahl, weiss / Glas satiniert, Motiv Fussball

Applique/Plafonnier; acier, blanc / verre satiné, motif football

Ø 245



E27



1x 60W



9 002759 872847



Ø 245



97667



92147



92146

97667 TABARA

ceiling light; wood, steel, green, white / satin glass, football motif

Deckenleuchte; Holz, Stahl, grün, weiss / Glas satiniert, Motiv Fussball

plafonnier; bois, acier, vert, blanc / verre satiné, motif football

H 80, Ø 400



E27 1x 60W

92146 VIKI 1

wall/ceiling light; steel, blue / satin glass, white

Wand- / Deckenleuchte; Stahl, blau / Glas satiniert, weiss

Applique/Plafonnier; acier, bleu / verre satiné, blanc

Ø 630, A 80



E27 1x 25W

92147 VIKI 1

wall/ceiling light; steel, pink / satin glass, white

Wand- / Deckenleuchte; Stahl, pink / Glas satiniert, weiss

Applique/Plafonnier; acier, rose / verre satiné, blanc

Ø 615, A 80



E27 1x 25W



9 002759 976675



Ø 400



9 002759 921460



Ø 630



9 002759 921477



Ø 615



KITCHEN & FUNCTIONAL LUMINAIRES

KÜCHEN- & FUNKTIONSLEUCHTEN
LUMINAIRES FONCTIONNELS & DE CUISINE



EN YOUR KITCHEN FRIEND

Our kitchen and function luminaires ensure the right lighting for your workplace and become true supporters. The practical and perfect fitted luminaires ideally refine your kitchen area.

DE IHR KÜCHENFREUND

Unsere Küchen- und Funktionsleuchten sorgen für die richtige Beleuchtung Ihrer Arbeitsfläche und werden zur wahren Alltagshilfe. Die praktischen Unterbauleuchten sind die perfekte Ergänzung für Ihren Küchenbereich.

FR VOTRE AMI DE CUISINE

Nos lumières fonctionnelles et de cuisine assurent le bon éclairage de votre surface de travail et deviennent une aide parfaite dans le quotidien. Les éclairages de meuble sont l'accompagnement parfait de votre espace de cuisine.





OVERVIEW

KITCHEN & FUNCTIONAL LUMINAIRES
KÜCHEN- & FUNKTIONSLEUCHTEN
LUMINAIRES FONCTIONNELS & DE CUISINE



DUNDRY
872-873

TEYA
874

KOB LED
875



This product is available in different colors and shapes. / Dieser Artikel ist in unterschiedlichen Farben und Formen verfügbar. /
Cet article est disponible en différentes couleurs et formes.





97572 DUNDRY

wall/ceiling light; plastic, white / plastic, white
Wand- / Deckenleuchte; Kunststoff, weiss / Kunststoff, weiss
Applique/Plafonnier; plastique, blanc / plastique, blanc

L 570, B 25, H 35



6,6W 850lm



9 002759 975722



97573 DUNDRY

wall/ceiling light; plastic, white / plastic, white
Wand- / Deckenleuchte; Kunststoff, weiss / Kunststoff, weiss
Applique/Plafonnier; plastique, blanc / plastique, blanc

L 870, B 25, H 35



9,3W 1250lm



9 002759 975739

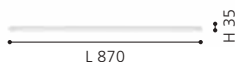

97574 DUNDRY

wall/ceiling light; plastic, white / plastic, white
Wand- / Deckenleuchte; Kunststoff, weiss / Kunststoff, weiss
Applique/Plafonnier; plastique, blanc / plastique, blanc

L 1170, B 25, H 35



12,8W 1700lm



9 002759 975746





97571

LED



97571 DUNDRY

wall/ceiling light; plastic, white / plastic, white
Wand- / Deckenleuchte; Kunststoff, weiss / Kunststoff, weiss
Applique/Plafonnier; plastique, blanc / plastique, blanc

L 310, B 25, H 35

LED

3,7W

neutral
WHITE

450lm



9 002759 975715





96081



96081

Mounting type: inkl. mounting clips Switch type: sensor switch (on/off)

Befestigungsart: inkl. Montageclips Schalterart: Sensor Schalter (ein/aus)

Type de fixation : clips de montage inclus Type de interrupteur : interrupteur capteur (on/off)

96081 TEYA

under cabinet light; aluminium, silver / plastic, white
Unterbauleuchte; Alu, silber / Kunststoff, weiss
éclairage de meuble; aluminium, argent / plastique, blanc

L 600, B 55, H 25



10W



950lm



9 002759 960810

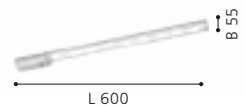



93707



93706



93707 KOB LED

under cabinet light; steel, satin nickel
 Unterbauleuchte; Stahl, nickel-matt
 éclairage de meuble; acier, nickel mat

L 600, B 70, H 25



3x 2,3W 780lm

93706 KOB LED

under cabinet light; steel, white
 Unterbauleuchte; Stahl, weiss
 éclairage de meuble; acier, blanc

L 600, B 70, H 25



3x 2,3W 780lm



9 002759 937072

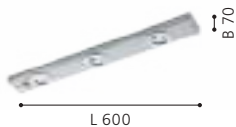

9 002759 937065





ACCESSORIES

ZUBEHÖR
ACCESSOIRES



EN MAKING IT SPECIAL

Supplement your personal luminaire range with practical accessories and make your everyday life easier.

DE DAS GEWISSE EXTRA

Ergänzen Sie Ihr persönliches Leuchtensortiment mit praktischem Zubehör und erleichtern Sie sich somit Ihren Alltag.

FR LE PETIT PLUS QUI COMPTE

Accompagnez votre collection personnelle de lumières par des accessoires pratiques et facilitez-vous ainsi votre quotidien.





OVERVIEW

ACCESSORIES
ZUBEHÖR
ACCESSOIRES



EXTENTION
881



ELEKTR.TRAFO
882



RUEDA
882



This product is available in different colors and shapes. / Dieser Artikel ist in unterschiedlichen Farben und Formen verfügbar. /
Cet article est disponible en différentes couleurs et formes.

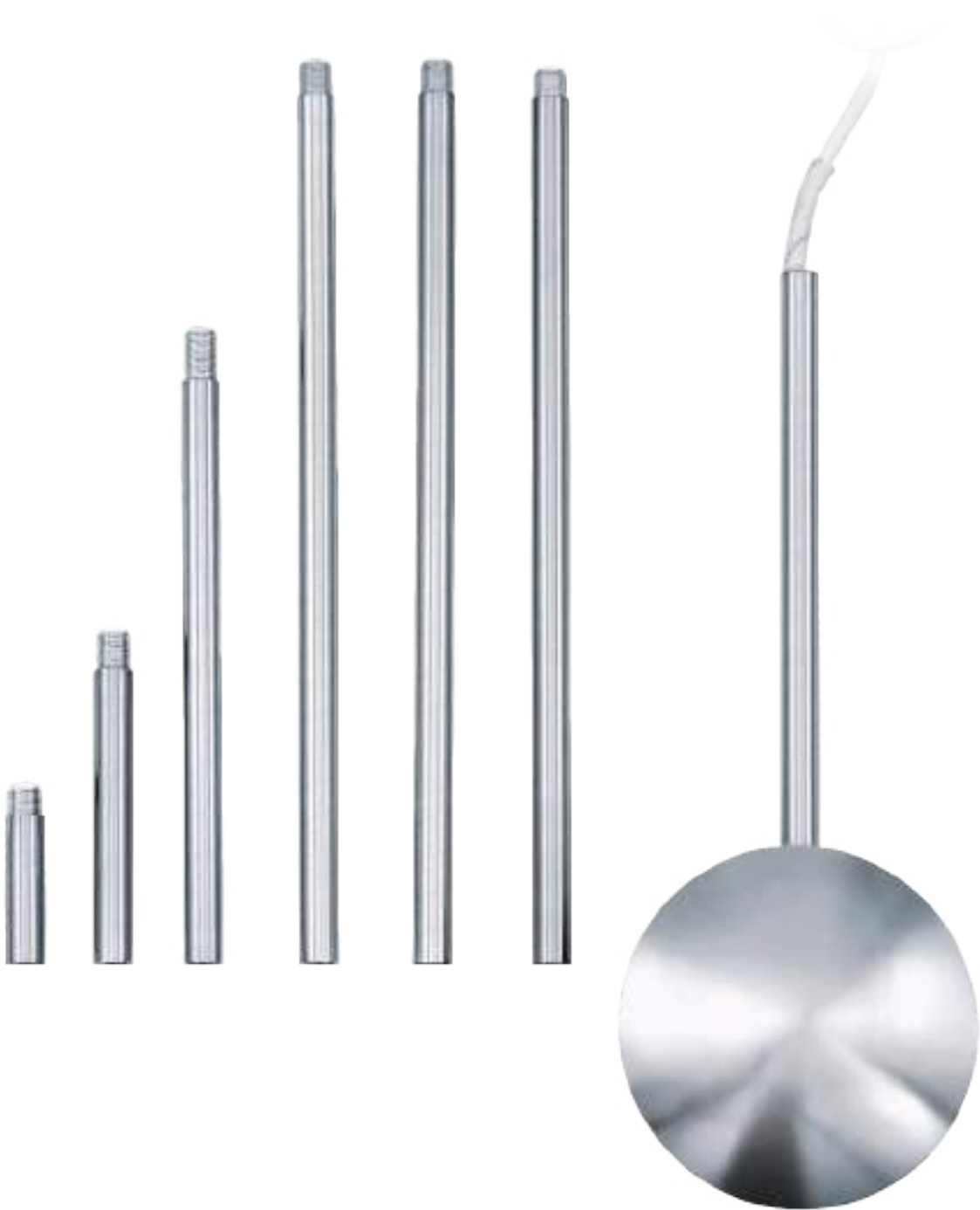





92288

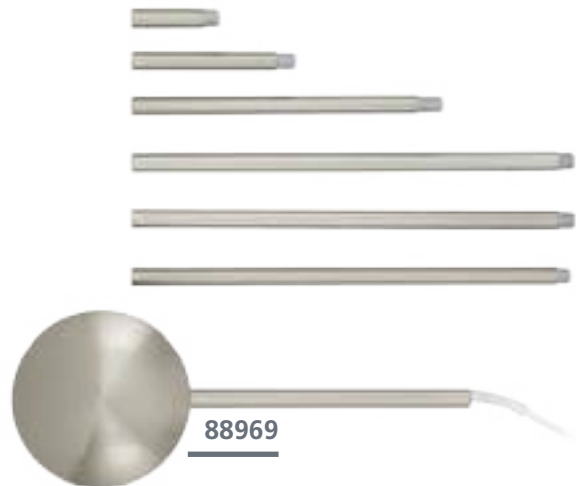

88969

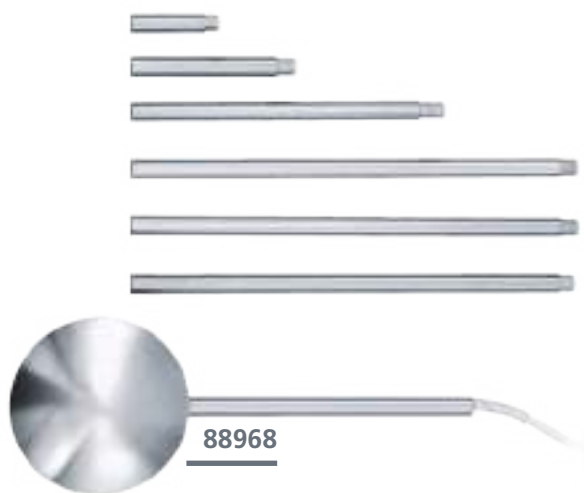

88968



EXTENTION

Can be extended or shortened from 320 to 1570 mm by screwing in/off the single pieces.

Der Kabelkanal kann durch Ein-/Ausdrehen der Einzelstücke von 320 bis 1570 mm verlängert bzw. verkürzt werden.

Le conduit de câble peut être prolongé ou raccourci en vissent/dévisent les pièces uniques de 320 à 1570 mm.

92288 EXTENTION

accessory; steel, white
Zubehör; Stahl, weiss
Accessoires; acier, blanc

L 1570, B 120

88969 EXTENTION

accessory; steel, satin nickel
Zubehör; Stahl, nickel-matt
Accessoires; acier, nickel mat

L 1570, B 120

88968 EXTENTION

accessory; steel, chrome
Zubehör; Stahl, chrom
Accessoires; acier, chrome

L 1570, B 120





RUEDA

Convert your single-flame luminaires into a three-flame light source for brighter illumination.

Verwandeln Sie Ihre einflammigen Leuchten in eine dreiflammige Lichtquelle für hellere Beleuchtung.

Transforme vos luminaires à une flamme en une source lumineuse à trois flammes pour un éclairage plus lumineux.



92348



98277



98279

92348 ELEKTR.TRAFO

accessory; plastic, white
Zubehör; Kunststoff, weiss
Accessoires; plastique, blanc

L 113, B 44, H 28



10



9 002759 923488



98277 RUEDA

accessory; plastic, white
Zubehör; Kunststoff, weiss
Accessoires; plastique, blanc

H 75, Ø 190



E27

3x 20W



9 002759 982775



98279 RUEDA

accessory; plastic, black
Zubehör; Kunststoff, schwarz
Accessoires; plastique, noir

H 75, Ø 190



E27

3x 20W



9 002759 982799





1

2



98277





INDEX & LEGEND

INDEX & ERKLÄRUNG
INDEX & LÉGENDE



EN **INDEX & LEGEND**

On the following pages you will get an insight into EGLO Worldwide, explanations of product pages and pictograms and an overview of the entire catalogue by means of indexes. Afterwards, you will also find space for your personal notes.

DE **INDEX & ERKLÄRUNG**

Auf den folgenden Seiten erhalten Sie einen Einblick in EGLO Weltweit, Erklärungen von Produktseiten und Piktogrammen und einen Überblick über den gesamten Katalog mittels Register. Anschließend finden Sie auch platz für Ihre persönlichen Notizen.

FR **INDEX & LÉGENDE**

Les pages suivantes vous donneront un aperçu d'EGLO Worldwide, des explications sur les pages de produits et les pictogrammes, ainsi qu'une vue d'ensemble du catalogue au moyen d'index. Ensuite, vous trouverez également de la place pour vos notes personnelles.

GLASS MATERIALS

GLAS-MATERIALIEN

MATÉRIAUX DEW VERRE



glass alabaster, white
Glas alabaster, weiß
verre albâtre, blanc

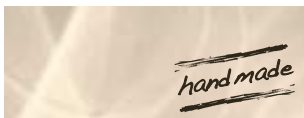

glass alabaster, champagne
Glas alabaster, champagner
verre albâtre, champagne



coating, black
Beschichtung, schwarz
revêtement, noir



glass wipe technique, champagner
Glas Wischtechnik, champagner
verre technique à l'essuyés, champagner

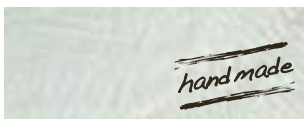

limed glass
Glas gekalkt
verre chaulé



brilliant glass
Brillantglas
verre brillant



structured glass
Glas mit Struktur
verre structuré blanc



molten splinters of glass/ brilliant glass (granille)
geschmolzene Splitter von Glas / Brillantglas (granille)
éclats fondus de verre / verre brillant (granille)



structured glass, white printed decor
strukturiertes Glas, weiß gedrucktes Dekor
verre structuré, décor imprimé blanc

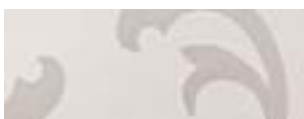

printed glass with decor
bedrucktes Glas mit Dekor
verre imprimé avec la décoration



glass painted, green
Glas lackiert, grün
verre laqué, vert



smoked glass, black-transparent
Rauchglas, schwarz-transparent
verre fumé, noir transparent



glass vaporized, black-transparent
Glas bedampft, schwarz-transparent
verre vaporisé, noir transparent



glass vaporized, amber
Glas bedampft, amber
verre vaporisé, ambre



gold-color
goldfarben
or

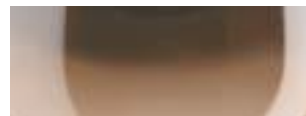

black-brown-transparent
schwarz-braun-transparent
noir-marron-transparent



black-grey-transparent
schwarz-grau-transparent
noir-gris-transparent



glass opal-matt
glas opal-matt
vere opale-mat



grey-matt
grau-matt
gris mat



sandy
sandfarben
couleur sable

EGLO WORLDWIDE SALES COMPANIES

EGLO WELTWEIT VERTRIEBSGESELLSCHAFTEN

EGLO DANS LE MONDE SOCIÉTÉS DE VENTE



AUSTRIA
EGLO LEUCHTEN GMBH

Heiligkreuz 22
6136 Pill
T: +43 5242 6996 110 | F: +43 5242 6996 972
info-austria@eglo.com



CHILE
EGLO CHILE ILUMINACIÓN LTDA.

Av. Américo Vespucio Norte 1930
Conchali - Santiago de Chile
T: +562 2 595 2222
info-chile@eglo.com



DENMARK
EGLO DANMARK A/S

Agerbakken 20
8362 Hørning
T: +45 70 22 55 11
info-denmark@eglo.com



AUSTRALIA
EGLO LIGHTING AUSTRALIA

5/339 Archerfield Road
4077 Richlands | Queensland
T: +61 7 3375 1413 | F: +61 7 3375 1412
info@eglolighting.com.au



CHINA
DONGGUAN EGLO LIGHTING
COMMERCIAL CO LTD

No.1 | Shangqiao Industrial Rd Shangqiao, Dongcheng
Dongguancity, Guanzhouprovince
T: +86 769 2203 3866 | F: +86 769 2203 6866
info-china@eglo.com



ESTONIA
MOODNE VALGUSTUS AS

Rävala pst. 7
10143 Tallinn
T: +372 667 6670 | F: +372 631 3195
info-estonia@eglo.com



BELGIUM
EGLO BELGIUM BV

Antwerpsesteenweg 247
2950 Kapellen
T: +32 3 250 60 80 | F: +32 3 219 80 67
info-belgium@eglo.com



COLOMBIA
EGLO COLOMBIA ILUMINACIÓN SAS

Autopista Norte 800 Mts adelante del Peaje de los Andes
Costado Oriental Km 19 Lote 30
Bogotá - Chia
T: +57 (1) 744 2339
info-colombia@eglo.com



FINLAND
EGLO FINLAND OY

Malmi raitti 17A
00700 Helsinki
T: +358 20 7649 820
info-finland@eglo.com



BOSNIA AND HERZEGOVINA
EGLO RASVJETA BH D.O.O.

Hrgovi Donji 178
76250 Gradacac
T: +387 35 86 85 00 | F: +387 35 82 44 41
info-Bosnia-Herzegovina@eglo.com | info@eglo.ba



COSTA RICA
EGLO COSTA RICA

Centro Comercial Calle Real local #8 de la sucursal del
BAC San José 800 metros al norte Guachipilín de Escazú
San José, Costa Rica
T: +506-2289-4690 | F: +506-2100-6384
info-costarica@eglo.com



FRANCE
EGLO FRANCE LUMINAIRE SARL

Z.A. Jeune Bois | 2 Rue de la Martinique
68274 Wittenheim
T: +33 3 89 62 50 45 | F: +33 389 6250 49
info-france@eglo.com



BULGARIA
EGLO BULGARIA EOOD

Main Road Burgas-Sofia | 5th kilometer | Building EGLO
8000 Burgas
T: +359 888 755 509
info-bulgaria@eglo.com



CROATIA
EGLO RASVJETA D.O.O.

Jadranska avenija 9
10020 Zagreb
T: +385 1 379 40 62 | F: +385 1 379 41 04
info-croatia@eglo.com



GERMANY
EGLO LEUCHTEN HANDELS GMBH

Kleinbahnstr. 35
59759 Arnsberg
T: +49 2932 6269 0 | F: +49 2932 6269 39
info-germany@eglo.com



CANADA
EGLO CANADA INC.

20700 Route Transcanadienne
H9X 4B7 Baie D'Ufré, Quebec
T: +1 514 457 5483 | F: +1 514 457 5487
info-canada@eglo.com



CZECH REPUBLIC
EGLO CZ+SK s.r.o.

Náchodská 2479/63
193 00 Praha 9
T: +420 281 924 163 | F: +420 281 925 205
info-czechrepublic@eglo.com



GREAT BRITAIN AND IRELAND
EGLO UK LTD.

Unit 12 Cirrus Park, Lower Farm Road, Moulton Park
Industrial Estate, Northampton NN3 6UR
T: +44 1604 790 986
info-UK@eglo.com

**GREECE**
EGLO HELLAS A.E.

Sykias 2 and parodos dekeleias
13679 Acharnai
T: +30 21 0800 2363
info-greece@eglo.com

**HUNGARY**
EGLO LUX KFT.

Fő út 143/A
2120 Dunakeszi
T: +36 27 341 353
info-hungary@eglo.com

**INDIA**
EGLO INDIA PRIVATE LIMITED

A-307, Ansal Chambers - 1, 3, Bhikaji Cama Place,
110066 Delhi
T: +91 85279 44288
info-india@eglo.com

**ITALY**
EGLO ITALIANA S.R.L.

Via Giotto, 4
31021 Mogliano Veneto (TV)
T: +39 041 45 66 245 | F: +39 041 45 74 066 / 071
info-italy@eglo.com

**KAZAKHSTAN**
EGLO KAZAKHSTAN LLP

Al-Farabi Avenue 7, Office 72, 14rd floor, Block 4A,
Nurly-Tau Business Center
50059 Almaty
T: +7 727 293 25 20 | M: +7 701 031 00 00
info-kazakhstan@eglo.com

**KOSOVO**
EGLO KOSOVA LLC

Lugisht e qytetit pn
20000 Prizren
T: +383 44 216 687 | SHOP: +383 49 699 100
info-kosovo@eglo.com

**LATVIA**
MOODNE VALGUSTUS AS

Rāvala pst.7
10143 Tallinn
T: +370 652 49923 | T: +372 667 6670
info-latvia@eglo.com

**LITHUANIA**
MOODNE VALGUSTUS AS

Rāvala pst.7
10143 Tallinn
T: +370 652 49923 | T: +372 667 6670
info-lithuania@eglo.com

**MALAYSIA**
EGLO ASIA SDN BHD

B-07-13, Empire Soho, Empire Subang, Jalan SS 16/1,
47500 Subang Jaya, Selangor Darul Ehsan.
T: +60162115313
info-malaysia@eglo.com

**MEXICO**
EGLO MÉXICO ILUMINACIÓN S DE RL DE CV

Prolongación Avenida López Mateos Sur N°3561,
Fraccionamiento Los Gavilanes
C.P. 45645 Tlajomulco de Zúñiga | Jalisco
T: +52 33 3687 20 95
info-mexico@eglo.com

**MIDDLE EAST**
EGLO LIGHTING MIDDLE EAST FZE

P.O. BOX 262073, LOB6, OFFICE G18
Jebel Ali, Dubai, UAE
T: +97 148810080 | F: +97 148810081
gulf@eglo.com

**MOROCCO - EGLO AFRICA**
EGLO MAGHREB LUMINAIRES SARL

219 Bd Med Zerktoouni. Suite: 67
20330 Casablanca
T: +212 522 98 80 25 / -05
info-global@eglo.com | info.africa@eglo.com

**THE NETHERLANDS**
EGLO VERLICHTING NEDERLAND B.V.

Innovatiepark 20
4906 AA Oosterhout (NB)
T: +31 162 48 28 30
info-nl@eglo.com

**NORWAY**
MS BELYSNING

Gardermovegen 95B
2030 Nannestad
T: +47 63 888500 | F: +47 63 888501
info-norway@eglo.com

**PERU**
EGLO PERU S.A.C

Av Primavera 1419
Distrito de Santiago de Surco y Departamento de Lima
T: +51 902 763 635
info-peru@eglo.com

**POLAND**
EGLO POLSKA SP. Z O.O.

Ul. Dźwiękowa 2
02-857 Warszawa
T: +48 22 644 57 55 | F: +48 22 644 89 82
info-poland@eglo.com

**PORTUGAL**
EGLO PORTUGAL ILUMINAÇÃO, LDA

Rua Fonte Parada, 125
4595-434 Seroa-Paços de Ferreira
T: +351 255 890 000
info-portugal@eglo.com

**ROMANIA**
EGLO ROMANIA PRODEXIM SRL.

Str. Atomistilor nr. 1D
77125 Magurele - Ilfov
T: +40 314 250 902 | F: +40 314 250 899
info-romania@eglo.com

**RUSSIA**
EGLO LIGHTING LLC

Varshavskoe shosse 3 | Office 23
117105 Moscow
T: +7495 789 4311 | F: +7495 789 4312
info-russia@eglo.com

**SERBIA**
EGLO RASVETA DOO

Stefana Prvovenčanog 28
11000 Beograd
T: +381 11 3981 366 | F: +381 11 3981 389
info-serbia@eglo.com

**SLOVAKIA**
EGLO CZ+SK s.r.o

Náchodská 2479/63
193 00 Praha 9
T: +421 313 211 551 | F: +421 313 211 556
info-slovakia@eglo.com

**SLOVENIA**
EGLO RASVJETA D.O.O.

Jadranska avenija 9
10020 Zagreb
T: +386 158 093 18
info-slovenia@eglo.com

**SPAIN**
EGLO ESPAÑA ILUMINACIÓN S.L.

Avda. de Castilla,1 (Edf. Best Point) 2º Planta - Oficina
16A-B
28830 San Fernando de Henares, Madrid
T: +34 91 677 90 44 | F: +34 91 677 03 04
info-spain@eglo.com

**SWEDEN**
EGLO SVERIGE AB

Star Street 1
512 50 Svenljunga
T: +46 340 623 505
info-sweden@eglo.com

**SWITZERLAND**
EGLO SCHWEIZ AG

Seetalstrasse 142
6032 Emmen
T: +41 41 268 69 59
info-switzerland@eglo.com

**TURKEY**
EGLO Aydınlatma ithalat ihracat Ltd. Şti.

Eyüp Sultan Mah. Sekmen Cad. No:18/2
34885 Sancaktepe / Istanbul Samandıra
T: +90 216 311 09 -02 / -03 / -04 |
F: +90 216 311 09 / -05
info-turkey@eglo.com

**UKRAINE**
EGLO UKRAINE LTD

Vatslava Gavela boulevard, 6/7-A,
03124 Kyiv
T: +38 067 670 58 61
info-ukraina@eglo.com

**USA**
EGLO USA, INC.

3640 Royal South Parkway
30349 Atlanta, Georgia
T: +1 404 477 5601 | F: +1 404 393 7053
info-usa@eglo.com

HOW TO READ

ERKLÄRUNG

COMMENT LIRE

ARTICLE NUMBER & SERIES NAME
ARTIKELNUMMER & SERIENNAME
NUMÉRO D'ARTICLE & NOM DE LA SÉRIE

DESCRIPTION
BESCHREIBUNG
DESCRIPTION

The product description is composed as follows:
luminaire type; enclosure material, enclosure colour /
glass or shade material, glass or shade colour
Die Produktbeschreibung setzt sich wie folgt zusammen:
Leuchtenart; Gehäusematerial, Gehäusefarbe / Schirm-
bzw. Glasmaterial, Schirm- bzw. Glasfarbe
La description du produit est composée comme suit:
type de luminaire; matériel de boîtier, couleur de boîtier /
matériel de verre ou abat-jour, couleur de verre ou abat-jour

DIMENSIONS
DIMENSIONEN
DIMENSIONS

all dimensions in mm | alle Größen in mm | toutes dimensions en mm

L = length | Länge | longueur

B = width | Breite | largeur

H = height | Höhe | hauteur

∅ = diameter | Durchmesser | diamètre

A = projection length | Ausladung | amplitude

ET = installation depth | Einbautiefe | profondeur utile

Base = base dimensions | Sockelmaße | dimensions de base

Attention! The dimensions relate solely to the sizes of the luminaire.
Any air spaces that would be relevant for a safe operating of the
lamp were not considered.

Achtung! Die Größen beziehen sich nur auf die Abmessungen der
Leuchte. Etwaige Lufträume, die für einen sicheren Betrieb der
Leuchte notwendig sind, werden nicht berücksichtigt.

Attention! Les dimensions se réfèrent à la taille de la lampe seule-
ment. Espacements éventuels, que seraient importants pour une
opération de la lampe sans danger, n'ont pas été considérés.

SKETCHES
SKIZZEN
CROQUIS

The sketches state the most meaningful dimensions. If a product
is adjustable by will, a turquoise arrow marks this function and
only the maximum dimensions are indicated.

Die Bemaßung der Skizzen umfasst jeweils die aussagekräftig-
sten Größen. Bei verstellbaren Produkten kennzeichnet ein
türkiser Pfeil diese Funktion und nur die maximalen Größen
werden angegeben.

Les dimensions des croquis comprennent les plus représenta-
tives. Si un produit est réglable au choix, une flèche turquoise
affiche cette fonction et rien que les dimensions maximales
sont indiquées.

99795 LIBERTAD
pendant light; steel, wood, black, brown
Hängeleuchte; Stahl, Holz, schwarz, braun
luminaire en suspension; acier, bois, noir, marron

L 180, B 180, H 1100
E27 1x 40W

99855 LIBERTAD
pendant light; steel, wood, black, brown
Hängeleuchte; Stahl, Holz, schwarz, braun
luminaire en suspension; acier, bois, noir, marron

L 880, B 180, H 1100
E27 3x 40W

99856 LIBERTAD
ceiling light; steel, wood, black, brown
Deckenleuchte; Stahl, Holz, schwarz, braun
plafonnier; acier, bois, noir, marron

L 860, B 180, H 240
E27 3x 40W

LIGHTING FAMILIES / STANDARD
234



PRODUCT / PRODUCT IN THE AMBIANCE
 PRODUKT / PRODUKTE IM AMBIENTE
 PRODUITS / PRODUITS DANS L'AMBIENCE

You can find the article number next to each product on the page and in the ambiance pictures.

Sie finden die Artikelnummer jedes Produktes neben der Abbildung auf der Seite und auf unseren Ambientebildern.

Vous pouvez trouver le numéro d'article à la page et à côté de chaque produit dans les images de l'ambiance.

CERTIFICATE
 ZERTIFIKAT
 CERTIFICAT



Information on FSC® - certified products can be found on page 8.

Informationen über FSC® -zertifizierte Produkte finden Sie auf Seite 8.

Vous trouverez des informations sur les produits certifiés FSC® à la page 8.

PICTOGRAMMES
 PIKTOGRAMME
 PICTOGRAMMES

Technical details are represented as pictograms. An overview over all pictograms can be found on the next pages.

Technische Details werden als Piktogramme dargestellt. Eine Übersicht über alle Piktogramme finden Sie auf den nächsten Seiten.

Les détails techniques sont représentés sous forme de pictogrammes. Vous trouverez un aperçu de tous les pictogrammes dans les pages suivantes.

BUTTONS
 BUTTONS
 BOUTONS

CRI >90 Colour Rendering Index | Farbwiedergabeindex | Indice de rendu de couleur de LED

INCL. Bulb included | Leuchtmittel inkludiert | ampoules inclus

RECESSED Recessed Luminaire | Einbauleuchte | luminaire encastrable

SURFACE Surface Luminaire | Aufbauleuchte | luminaire en saillie

900349 LIBERTAD 1

pendant light; steel, wood, black, brown
 Hängeleuchte; Stahl, Holz, schwarz, braun
 luminaire en suspension; acier, bois, noir, marron

L 760, B 140, H 1100

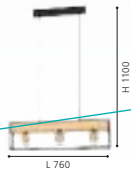

900349

The flower pots are included with this luminaire.

Bei dieser Leuchte sind die Blumentöpfe inkludiert.

Les pots de fleurs sont inclus avec ce luminaire.

LIGHTING FAMILIES / STANDARD
235

HOW TO READ / ILLUMINANTS

ERKLÄRUNG / LEUCHTMITTEL



















COMMENT LIRE / AMPOULES

1 PICTOGRAMMES PIKTOGRAMME PICTOGRAMMES

Technical details are represented as pictogrammes.

Technische Details werden als Piktogramme dargestellt.

Les détails techniques sont représentés sous forme de pictogrammes.

 Lumen Lumen Lumen	 Not dimmable Nicht dimmbar Pas de gradation	 Colour rendering index Farbwiedergabeindex L'indice de restitution de couleurs
 Not suitable as main light source Nicht als Hauptleuchtmittel geeignet Ne convient pas comme source lumineuse principale	 Step dimmable Stufen dimmbar gradation par étapes	 Beamangle Ausstrahlwinkel Angle de rayonnement
 Dimensions in mm Abmessungen in mm Dimensions en mm	 Control unit Stufen dimmbar unité de contrôle	 Day/night-sensor Tag/Nacht-Sensor Capteur jour/nuit
 Wattage Wattage Puissance	 Lifetime Steuereinheit Durée de vie	 Motion-sensor Bewegungsmelder Détecteur de mouvement
 Operating voltage Betriebsspannung Tension de fonctionnement	 Selling Unit Verpackungseinheit Unité d'emballage	 Motion-sensor & day/night-sensor Bewegungsmelder & Tag/Nacht-Sensor Détecteur de mouvement et détecteur jour/nuit
 Socket Sockel Douille	 Comparative value of brightness to conventional light bulbs Vergleichswert der Helligkeit zu konventionellen Glühlampen Valeur comparative de la luminosité par rapport aux ampoules à incandescence conventionnelles	 incl. battery inkl. Batterie incl. pile
 Dimmable Dimmbar Dimmable		





1

12251 GU10-LED

 **345 lm**

 **2700-6500 K**





 L 59, Ø 50

 4.9 W

 220-240V, 50/60Hz

 GU10

 dimmable via remote & app

 15000 h

 4.9 W ~ 50 W

 83 CRI

 45°

 9 002759 122515

 DIMMABLE VIA REMOTE AND APP













2

LIGHT COLOUR & KELVIN LICHTFARBE & KELVIN COULEUR LUMINEUX & KELVIN

The colours of the LED are represented as pictogrammes (see below), their luminous flux directly beneath. The luminous flux is quoted in lumen and describes the amount of light generated by the LED. The higher the value, the brighter is the lamp. Lumens are LED boards and are the light measurement value in bulbs.

Die Farben der LED werden als Piktogramm (siehe unten) dargestellt, deren Lichtstrom direkt darunter. Der Lichtstrom wird in Lumen gemessen und gibt die erzeugte Lichtmenge der LED an. Je höher der Wert, desto heller das Produkt. Lichtstromangaben (Lumen) sind Platinen- bzw. Leuchtmittelwerte.

Les couleurs de DEL ont représentés sous forme de pictogrammes, leur flux lumineux directement en dessous. L'unité de flux lumineux est le lumen et il mesure la quantité de lumière générée par les DEL. Plus la valeur est élevée, plus la lampe est lumineuse. Les lumens sont l'unité de mesure de l'intensité lumineuse des ampoules et des panneaux led intégrés.

 RGB	RGB RGB RGB	 RGB+NW	RGB + neutralwhite RGB + neutralweiß RGB + blanc neutral	 cold WHITE	cold white kaltweiß blanc froid
 RGB+W	RGB + white RGB + weiß RGB + blanc	 RGB+TW	RGB + tunable white RGB + tunable white RGB + tunable white	 neutral WHITE	neutral white neutralweiß blanc neutre
 RGB+WW	RGB + warmwhite RGB + warmweiß RGB + blanc chaud	 tunable WHITE	tunable white tunable white tunable white	 YELLOW	Yellow Gelb Jaune
 RGB+CW	RGB + coldwhite RGB + kaltweiß RGB + blanc froid	 warm WHITE	warm white warmweiß blanc chaud	 RED	Red Rot rouge

3

ENERGY EFFICIENCY LABELS ENERGIEEFFIZIENZ-LABEL LABEL DE L'EFFICACITÉ ÉNERGÉTIQUE

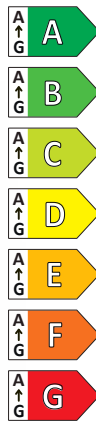
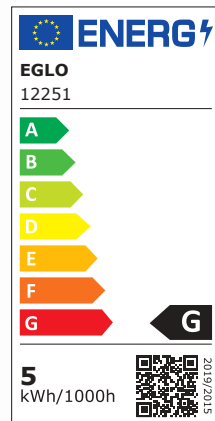

The new energy label must be indicated on all light sources with a luminous flux between 60 and 82,000 lumens and LED. This applies to lamps, LED modules and luminaires where the light source cannot be removed without destroying it. The energy spectrum ranges from A to G.

Das neue Energielabel muss auf allen Lichtquellen mit einem Lichtstrom zwischen 60 und 82.000 Lumen und LED angegeben werden. Dies gilt für Lampen, LED-Module und Leuchten, bei denen die Lichtquelle nicht zerstörungsfrei entnommen werden kann. Das Energiespektrum reicht von A bis G.

Le nouveau label énergétique doit être indiqué sur toutes les sources lumineuses dont le flux lumineux est compris entre 60 et 82 000 lumens et sur les LED. Cela s'applique aux lampes, aux modules LED et aux luminaires dont la source lumineuse ne peut être retirée sans être détruite. Le spectre énergétique va de A à G.

The information on the label includes: /
Die Angaben auf dem Etikett beinhalten: /

Les informations figurant sur l'étiquette sont les suivantes :



















- › Name/Trademark / Name/Warenzeichen / Nom/marque de commerce
- › Model / Modell / Modèle
- › Energy label scale A-G / Energielabel-Skala A-G / Échelle d'étiquetage énergétique A-G
- › Energy consumption for 1,000 hours of use / Energieverbrauch bei 1.000 Stunden Nutzung / Consommation d'énergie pour 1 000 heures d'utilisation
- › Energy efficiency class of the product / Energieeffizienzklasse des Produkts / Classe d'efficacité énergétique du produit
- › QR Code to EPREL (Product Database of the European Product Registry for Energylabelling) / QR Code zur EPREL (Produktdatenbank der European Product Registry for Energylabelling) / Code QR pour EPREL (base de données des produits du registre européen des produits pour l'étiquetage énergétique)

PICTOGRAM









PIKTOGRAMME

PICTOGRAMME

SOCKETS / FASSUNGEN / DOUILLES

 LED	 G4	 G53
 2G7	 G5	 GU5,3 / MR16
 2G11	 G9	 GU10
 2GX13	 G10Q	 GX53
 E14	 G13	 GY6,35
 E27	 G23	 R7s

BULBS / LEUCHTMITTEL / AMPOULES











 E14 / C35	 E27 / A60 Halogen	 E27 / E140 Filament
 E14 / C35f	 E27 / R63 Halogen	 E27 / PS160 Filament
 E14 / D45	 E27 / A60 LED	 E27 / T30 Filament
 E14 / C35f LED	 E27 / A60 Filament	 E27 / T32 Filament
 E14 / D45 Halogen	 E27 / A65 LED	 G4 / T9
 E14 / C35 Halogen	 E27 / A75 Filament	 G4 / LT9
 E14 / T22	 E27 / G45 LED	 G4 / LT14
 E14 / C35 Filament	 E27 / G45 Filament	 G9
 E14 / C37 Filament	 E27 / G80 Filament	 G9 LED
 E14 / C35f Filament	 E27 / G95	 GU10
 E14 / C37f Filament	 E27 / G95 Filament	 GU10 LED
 E14 / P45 LED	 E27 / G125	 GU10 SMD LED
 E14 / P45 Filament	 E27 / G95 LED	 GX53 / LF75
 E14 / P50	 E27 / G200 Filament	LED LED board / LED Platine / LED bord
 E14 / ST48 Filament	 E27 / R63 LED	 MR16
 E14 / ST64 Filament	 E27 / ST48 Filament	 MR16 LED
 E14 / T20 LED	 E27 / ST64 Filament	 R7s / 78mm
 E27 / A60	 E27 / B80 Filament	 R7s / 118mm
 E27 / G90	 E27 / BR150 Filament	 R7s / 78mm LED
 E27 / QR63	 E27 / DP165 Filament	 R7s / 118mm LED

LIGHT COLOUR & LUMEN / LICHTFARBE & LUMEN / COULEUR LUMINEUX & LUMEN

















The colours of the LED are represented as pictogrammes (see below), their luminous flux directly beneath. The luminous flux is quoted in lumen and describes the amount of light generated by the LED. The higher the value, the brighter is the lamp. Lumens are LED boards and are the light measurement value in bulbs.

Die Farben der LED werden als Piktogramm (siehe unten) dargestellt, deren Lichtstrom direkt darunter. Der Lichtstrom wird in Lumen gemessen und gibt die erzeugte Lichtmenge der LED an. Je höher der Wert, desto heller das Produkt. Lichtstromangaben (Lumen) sind Platinen- bzw. Leuchtmittelwerte.



















Les couleurs de LED ont représentés sous forme de pictogrammes, leur flux lumineux directement en dessous. L'unité de flux lumineux est le lumen et il mesure la quantité de lumière générée par les LED. Plus la valeur est élevée, plus la lampe est lumineuse. Les lumens sont l'unité de mesure de l'intensité lumineuse des ampoules et des panneaux led intégrés.

	RGB RGB RGB		RGB + neutralwhite RGB + neutralweiß RGB + blanc neutral		cold white kaltweiß blanc froid
	RGB + white RGB + weiß RGB + blanc		RGB + tunable white RGB + tunable white RGB + tunable white		neutral white neutralweiß blanc neutre
	RGB + warmwhite RGB + warmweiß RGB + blanc chaud		tunable white tunable white tunable white		
	RGB + coldwhite RGB + kaltweiß RGB + blanc froid		warm white warmweiß blanc chaud		

SWITCHES & SENSORES / SCHALTER & SENSOREN / INTERRUPTEUR & CAPTEURS

	incl. cable & plug inkl. Kabel & Stecker câble & connecteur inclus		pedal switch Trittschalter interrupteur à pied		swedish plug Stecker Schweden connecteur swede
	internal dimmer eingebauter Dimmer variateur intégré		cable switch Kabelschalter interrupteur à câble		"Touch me" ON/OFF "Touch me" EIN/AUS "Touch me" ON/OFF
	button switch Druckknopf interrupteur de pression		incl. cable & plug transformer inkl. Kabel & Stecktransformator câble & transformateur à prise		"Touch me" ON/OFF & dimm "Touch me" EIN/AUS & Dimmen "Touch me" ON/OFF & graduable
	function switch Funktionsschalter interrupteur fonction		remote control Fernbedienung télécommande		pull switch Zugschalter interrupteur à bascule
	rocker switch Wippschalter interrupteur à bascule		Day & Night Sensor Tag & Nacht Sensor sensor jour & nuit		Timer - automatic on/off Zeitschaltuhr - automatisches Ein- & Ausschalten minuterie - peut être éteint et allumé automatiquement
	pedal dimmer Trittdimmer variateur à pied		sensor Sensor sensor		

FUNKTIONS & COMFORT / FUNKTIONEN & KOMFORT / FONCTIONS & CONFORT



	incl. battery inkl. Akku incl. pile		cutout (in mm) Ausschnitt (in mm) perçage du panneau (en mm)		packaging / delivery unit Verpackungs- / Liefereinheit unité d'emballage / de livraison
	incl. battery inkl. Batterie incl. pile		dimmable with external dimmer dimbar mit externen Dimmer gradable avec un gradateur externe		shortable kürzbar réductible
	battery specifications Batteriespezifikationen spécifications des piles		not dimmable nicht dimmbar ne pas graduable		Voltage Volt Voltage
	beam angle Ausstrahlwinkel angle de rayonnement		Can be operated via control unit Bedienbar über Steuergerät Peut être commandé par une unité de contrôle		Watt
	corner mount possible Eckmontage möglich montage en coin possible		replaceable LED austauschbare LED LED remplaçables		USB connection USB-Anschluss Connexion USB
	Colour Rendering Index		loadable in kg belastbar in kg chargeable en kg		Qi-Charger

PROTECTION CLASS / SCHUTZKLASSE / CLASSE DE PROTECTION

The protection class indicates to what extent the lamp is protected against electric shock. All lamps in this catalogue are at least protected with the protection class 1 - a higher class is specified in the information box of the respective lamp.

Die Schutzklasse gibt an, inwiefern ein Produkt gegen einen elektrischen Schlag gesichert ist. Alle Leuchten in diesem Katalog sind mit mindestens Schutzklasse 1 gesichert, bei höheren Klassen wird das Symbol im Infokasten der Leuchte angegeben.

La classe de protection indique, dans quelle mesure la lampe est protégée contre les chocs électriques. Tous les lampes dans ce catalogue sont protégés au moins avec la classe 1 - une classe plus élevée est indiquée dans l'information de la lampe.

	protection class 1: protective earthing Schutzklasse 1: Schutzerdung classe de protection 1: prise de terre		protection class 2: protective insulation Schutzklasse 2: Schutzisolierung classe de protection 2: double isolation ou renforcée		protection class 3: protective low voltage Schutzklasse 3: Schutzkleinspannung classe de protection 3: très basse tension de sécurité
---	---	---	--	---	---

PROTECTION RATING / SCHUTZGRAD / INDICE DE PROTECTION

The protection rating ensures the operational safety of luminaires. The first number specifies the extent of the protection against the ingress of foreign bodies; the second number identifies the humidity protection grade. All luminaires in this catalogue are at least protected with the rating IP20 - a higher rating is specified in the information box of the luminaire.

Der Schutzgrad gewährleistet die Betriebssicherheit von Leuchten. Die erste Ziffer des IP Grades beschreibt den Schutzzumfang gegen das Eindringen von Fremdkörpern; die zweite Ziffer informiert über den Grad des Feuchtigkeitsschutzes. Alle Leuchten in diesem Katalog sind mit mindestens Schutzgrad IP20 gesichert, bei höheren Graden wird das Symbol im Infokasten der Leuchte angegeben.

L'indice de protection assure la sécurité opérationnelle des luminaires. Le premier chiffre indique à quel point la protection est efficace contre l'insertion de corps étrangers; le second chiffre indique quant à lui le degré de protection par rapport à l'humidité. Tous les luminaires dans ce catalogue sont protégés au moins avec l'indice IP20 - un indice plus élevé est indiqué dans l'information d'article.

	IP33		IP44		IP54		IP65		IP67
---	------	---	------	---	------	---	------	---	------

REGISTER

SERIES NAMES

SERIENNAMEN

NOME DE PRODUITS

NAME NAME NOM	PAGE SEITE PAGE	NAME NAME NOM	PAGE SEITE PAGE	NAME NAME NOM	PAGE SEITE PAGE
ABREOSA	248	ARENAZA	831	BELSIANA	502-503
ACOLLA	523	ARISCANI	362-363	BELSIANA 1	503
AGLIENTINA	203	ARRECIFE	703	BENARIBA	547
AGUILARES	353	BAJAZZARA	212-213	BERREGAS	694
ALAMILO	593	BANDERALO	832	BILBANA	815
ALBANY	469	BANKER	856	BIMEDA	738-741
ALBARACCIN	372-373	BARBANO-Z	28-29	BITACHITO	405
ALBARIZA	196	BARBOTTO	270-273	BOCADELLA	400
ALCUDIA	656	BARI 1	673	BOCADELLA 1	500
ALEANDRO 1	380	BARI-M	630	BOLIVIA	436
ALESSANDRA	469	BARNHAM	734-735	BOLSANO	382
ALMEIDA	205	BARRANCAS	506	BORDONARA	498
ALMEIDA 1	204	BASIC	858-859	BORGILLO	799, 854-855
ALMEIDA 2	200-201	BASIC 1	858	BOYAL	240-243
ALMERA	583	BASILANO	342-343	BRENDA	464-466
ALMONTE	624	BASILANO 1	340-341	BROLINI	839
ALMUDAINA	250-251	BASURTU	518	BUCAMARANGA	178
ALOBRASE	355, 358-361	BATABANO	815	BUDENSEA	796
ALTAFLOR	484-486	BATALLAS	686-687	BUENAVISTA	674
ALVEZ	471	BATISTA	355	BUENAVISTA 1	676
AMANDOLO	480-481	BATISTA 3	381, 813	BUENAVISTA 2	676-677
AMEZAGA	816	BATTISTONA	546	BUTRANO	419
AMEZOLA	620	BAYA	804	BUZZ-LED	756-761
AMONTILLADO	414	BAYA LED	802-803	CABADO	776
ANCHORENA-Z	24-25	BAYMAN	299	CABADO 1	851
ANDABAIA-Z	43	BELESER	367, 795	CABALES	848-849
ANDREAS-Z	23	BELLARIVA	810	CABO	522
ARANZOLA	793	BELLARIVA 3	809	CABO 1	764

NAME NAME NOM	PAGE SEITE PAGE	NAME NAME NOM	PAGE SEITE PAGE	NAME NAME NOM	PAGE SEITE PAGE
CABUS	663	CARPENTO	344	CORREDERA	418
CADAQUES	361	CARTAMA	391	CORTADERAS	406,792
CADAQUES 1	361	CARTIGNANO	590	CORTENOVA	394
CADEGAL	608-609	CASIBARE	252-253,698	COSLADA	710
CAGUANES	452	CASTRALVO	454	COSSANO	224-225
CAHUAMA	812	CAUPO	838	COSSANO 2	224-225
CAJERO	850-851	CAYUCA	743	COSWARTH	700
CALAGRANO	564-565	CENCIARA	461,515	COTORRO	689
CALAGRANO-Z	50-51	CEPPINO	844-845	CREMELLA	254-255
CALMANERA	432-433	CERASELLA	375	CUMIOLE	404
CALNOVA	657	CHIETINO 1	809	CURASAO	430
CAMACHO	238-239	CIGLIE	589	DAKAR 1	728-729
CAMASCA	437	CIUDEDELA	423,817	DAKAR 3	778
CAMASTRA	441	CIVITATE	591	DAMASCO 1	821-822
CAMBAITO	436	CLAVELLINA	308-309	DAMBERA	846
CAMBULOS	414	CLEMENTE	383,523	DAVIDA	746-747
CAMINALES-Z	94	CODRIALES	316-317	DAVIDA 1	748-749
CAMPANIA	584	COGNOLI	840	DESIERTO	825
CAMPILO	446	COLTI	584	DUAIA	516
CANICOSA 2	530	COMINIO	357	DUNDRY	872-873
CANTERRAS	246-247	COMPETA 1	548-549	DURELO	569
CAPALBIO	811	CONCESSA 1	194-195	DURENGO	846
CAPASSO	550	CONDRADA 1	522	ELEKTR.TRAFO	882
CAPRAROLA	356,817	CONESA	790	ELIZONDO	604
CARANACOA	312-313	CONESSA	388-389	ELLA	568
CARBONERAS	796	CONNECT Z	21	ENCINITOS	431,505
CARDILLIO 1	766-767,769	CONNECT-Z SENSOR	21	ENEA	730-731
CARDILLIO 2	768-769	CONNECT-Z SWITCH	21	ERMUA	415,815
CARDITO 1	384-385	CONSACA	696	ERSEKA	274-275
CARLTON 2	807	CONTRISA	456	ERVIDEL	306-307
CAROSSO-Z	96-97	CORATO	733	ESCANDELL	266-267
CAROVIGNO	704	CORETTO	377	ESCANDIDOS	262-263

NAME NAME NOM	PAGE SEITE PAGE	NAME NAME NOM	PAGE SEITE PAGE	NAME NAME NOM	PAGE SEITE PAGE
ESPARTAL	791	GENOVESE-Z	53	LANCIANO-Z	90
ESTEPERRA	166, 169, 690	GEO	823	LAROA	842-843
ESTEVAU	422	GERBERA 1	584	LASANA	328
EXTENTION	881	GEXO	848	LASANA 1	324, 329
FABIO	776-777	GIANELLA	318-319	LASANA 2	324-325
FALICETTO	604	GINESTRONE-Z	33	LASANA 3	326-327
FARSALA	365	GIRON	532	LAURITO	556
FATTORIA	218-219	GIRON-S	533	LAZOLO	466
FELONICHE	597	GIRONA	713	LEBALIO	353
FENIGLIA	198-199	GITA 2	660	LED CARPI	636-637
FERENTINO	544-545	GOROSIBA	286-287	LED PALERMO	634-635
FILAGO	452, 521	GOROSIBA 1	286	LED STRIPE-Z	98-99
FIRMO	857	GRADOLI	402	LEJIAS	322-323
FLORESTA	426	GRADOLI 1	403	LIBERTAD	234, 236
FONDACHELLI	788	GRAFIK	581	LIBERTAD 1	235
FORCADET	519	GUANAL	606	LISCIANA	417
FOX	860	GURARE	593	LM_LED_E14	101
FRADELO	526-527	HAYES	605	LM_LED_E27	100-111
FRADELO 1	524-525	HERRORA-Z	74	LM_LED_GU10	101
FRAIOLI-Z	40-41	HORNWOOD-Z	26	LOBATIA	409
FRANIA	534-535, 538-539, 631-632	IMPERIAL	582	LOBINERO-Z	42
FRANIA-A	123	INIESTA	834	LOCANDA	739
FRANIA-S	536-537, 540-541, 631, 633	IPOLITTO	490	LOMALTAS-Z	45
FUEVA 5	638-644, 646	ISIDRO	310-311	LONCINO 1	379
FUEVA-A	128	JUNIOR 1	866	LORD 2	468
FUEVA-Z	76-87	KOB LED	875	LORETO	518-519
GAETANO 1	458-459, 462	KOKOMO-Z	26	LORETO 1	519
GAFARES	488-489	LA SECA	837	LOSALOMAS	435
GASCUERIA	604	LACEY-QI	833	LUBERIO	386
GATUELA 1	412-413	LAGUNITAS	374	LUPPINERIA	560-562
GAZZOLA	439	LANCIANO	542	LURONE	264-265
GEMILIANA	654-655	LANCIANO 1	542-543	MACCACARI	596

NAME NAME NOM	PAGE SEITE PAGE	NAME NAME NOM	PAGE SEITE PAGE	NAME NAME NOM	PAGE SEITE PAGE
MACCHIONE	509	MENTALURGIA	567	NARICES	268-269,407
MADONNINA	818	MESSINARO	502	NARICES 1	268
MAGITTA 1	580	MESTRE	582-583	NASTASIA	202
MAGNUM LED	763	METRASS	610	NEMO	581
MAGNUM-LED	762-763	METRASS 1	613	NEVADO	333
MANALBA	808	METRASS 2	611	NIEVES	553
MANALBA 1	808	MEZZANA	400	NIEVES 1	552
MANILVA 1	632	MINI 4	778-779	NOCITO	736-737
MANIZALES	403	MINIERE	457	NUVANO	461
MANNERA	786-787	MIOGLIA 1	388	OBREGON	447
MANTUNALLE	368	MIRLAS	494	OILELLA	350-351
MANTUNALLE 1	367	MOGANO	512-513	OKINZURI	422
MANZANARES	276-277	MOGANO 1	462	ONEDA	792
MARSALES	172,174	MOGANO 2	514	ONO 2	595
MARBELLA	304-305	MOGANO 3	505	OPTICA	282-284
MARGHERA-Z	36-37	MOHARRAS	515	PADROGIANO-Z	58-60
MARGITTA 1	575	MONIROTE	485,487	PADULARI	482
MARIEL	457,520	MONTEBALDO	405,506	PALAGIANO	565
MARINELLO	493	MONTEFINO	392	PALAGIANO 1	566
MARINELLO 1	492	MONTEFIO	466	PALERMO 2	549
MARMORATA	499	MONTEFIO 1	386-387	PALMERA	672
MAROJALES	520	MONTEMORELOS-Z	52-53	PALMITAL	628-629
MARONDA	205	MONTENOVO	531	PALOMARO	142-143
MARS	577-578	MORDAZO	507	PALOMARO 1	143
MARS 1	576-577	MOSIANO	630	PALOMBAIA	216
MARYVILLA	354,817	MULEGES	428	PALOZZA	335
MASERLO	180-181, 184-186, 188-193	MURCIA	300-301	PALOZZA 1	334
MASERLO 1	182-183	MURMILLO	364	PANAGRIA	244-245
MASERLO 2	180, 186, 189, 192	MURNIA	814	PANDELLA 1	666-669
MASETA	424-425	MUSURITA	554-555	PANDELLA 2	666,670
MASSERIE	830	NADINA	791	PARANDAY-Z	46-47
MATTANZA	220	NARANJO	825	PARRAPOS-Z	48-49

NAME NAME NOM	PAGE SEITE PAGE	NAME NAME NOM	PAGE SEITE PAGE	NAME NAME NOM	PAGE SEITE PAGE
PASCAL 1	583	REMIDOS	609	SALOME	578-579
PASSA	600-603	RENDE	551	SALTO	770-771
PASTERI	138-141, 146-153, 155-161, 806	RICCIO 1	777	SALVILANAS-Z	34-35
PASTORE	144	RIVATO	298	SAMBATELLO	706-707, 709
PASTORE 1	144	ROCAMAR	376, 378	SAN PERI	586
PASTORE 2	145	ROCAMAR 1	377-378	SAN PERI 1	621
PEGUERA	653	ROCCAFORTE	442-445	SANIA 4	598-599
PENJAMO	563	ROLIMARE	483	SANIA 5	650-651
PENJAMO 1	562	ROMAGNESE	380	SARGINTO	614-615
PESCAITO	554	ROMAO	136-137	SARONA	408, 816
PETTO 1	814	ROMAO 1	136	SARRIA	750-753
PICACHA	799	ROMAO 3	136-137	SARSINA-A	124
PICCOLA	785	ROMAO-Z	30	SARSINA-Z	68-69
PIEDRITAS	510	ROMAZZINA	256-259	SAVATARILA-Z	62-63
PINETINA	407	ROMENDO 1	648-649	SAVOY	302-303
PINETTO	634-635	RONCADE	331, 334	SCALEA 1	580
PINTO	294-295	RONCADE 1	330	SEGEZIA	440
PINTO GOLD	292-293	RONDO	278-280	SEGOVIA	214-215
PINTO NERO	290	RONDO 3	280, 407	SELLANO	836
PINTO TEXTIL	289	RONDO 4	794	SELUCI	556-557
PINTO TEXTIL 1	288	ROTTELO	754-755	SELVINA	331-332, 335
PLANET	570	ROVIRA	413	SELVINA 1	330
PLANET 1	570-573	ROVITO-Z	54-57	SELVINO	370-371
PODERE	438	RUEDA	882	SENDERO	226-227
POLLICA	692	RUOTALE	417, 482	SERAS	722-723, 726-727
PORTICO-Z	27	RUSTICARIA	217	SERAS 1	720-721
POZONDON	531	SABINAR	448-449, 451	SERAS 2	724-725
POZUETA	399	SALICETO-Z	95	SIBERIA	320-321
POZUETA 1	397	SALITERAS-Z	63	SIDERNO	650
RAMON	441	SALITRE	418	SILENTINA	508-509
RAZONI	420-421	SALOBRENA-A	126-127	SILERAS	541
RAZONI 1	420-421	SALOBRENA-Z	70-73	SILERAS-Z	91

NAME NAME NOM	PAGE SEITE PAGE	NAME NAME NOM	PAGE SEITE PAGE	NAME NAME NOM	PAGE SEITE PAGE
SILVARES	410	TIMPAROSSA	592	VENEZUELA	260-261
SIMOLARIS-Z	38-39	TINDORI	222-223	VERADAL	844
SLIM	821	TIRRENARA	492	VERADAL-QI	833
SNAPORA	846	TOLLOS-Z	31	VERDELLO	653-654
SOLO	821	TOLORICO	626	VERGIANO	745
SOLO 1	820	TORONA 1	852	VETRO	470-471
SOLO 2	819	TORRETTA	657	VIGLIONI	453
SOREGO	744	TOTARI-Z	88-89	VIKI 1	867
SORRENTA 1	529	TOWNSHEND 3	682-685	VILANOVA	764-765
SPADAFORA	414	TRAGACETE 1	658-659	VINCHIO	670
STAITI	507	TREMEDAL	501	VINOVO	300
STAITI 1	586	TRONDIO	809	VISERBELLA	162-164
STELLATO 1	220-221	TROY 3	296-297	WASAO 1	632
STELLATO 2	221	TRUNCA	830	YUKU-Z	27
STELLATO 3	221	TUDONS	595	ZAMPOTE	490
STICKER	673	TURCONA-Z	64,66-67	ZAPATA	719
SWARBY	813	TURIALDO	232	ZAPATA 1	716
TABARA	867	TURIALDO 1	813	ZARAGOZA	176-177
TABIANO	663	ULISANO	482	ZERACO	753
TABIANO-Z	44	UP 2	800-801	ZILLERIO-Z	42
TABILLANO	714	VADUMI	664	ZINACUA	593
TABILLANO 1	852	VALBIANO	691	ZOCABON	426
TAMARA 1	622-623	VALCASOTTO	559	ZOLA	672
TAMURIA	496	VALCASOTTO 1	517	ZUBIALDE	594
TANURA	606	VALDIOLA	434	ZUBIETA-A	120-122
TARANDELL	329	VALLASPRA	381		
TAREGA	411	VALLEMARE	529		
TARRAFO	453,517	VALLEROSA	314-315		
TAZZOLI	589	VALMORA	332-333		
TELIBELA-Z	92-93	VARILLAS	171		
TERRAROSA	429	VARRAZO	385		
TEYA	874	VELASCO	210-211		

REGISTER

ARTICLE NUMBER

ARTIKELNUMMER

NUMÉROS D'ARTICLE

NUMBER NUMMER NUMÉRO	PAGE SEITE PAGE	NUMBER NUMMER NUMÉRO	PAGE SEITE PAGE	NUMBER NUMMER NUMÉRO	PAGE SEITE PAGE	NUMBER NUMMER NUMÉRO	PAGE SEITE PAGE	NUMBER NUMMER NUMÉRO	PAGE SEITE PAGE	NUMBER NUMMER NUMÉRO	PAGE SEITE PAGE
3041	470	12245	109	31577	151	31997	334	39092	342	82844	801
3355	469	12251	101	31578	155	32048	328	39093	343	82942	570
7184	578	12252	101	31581	146	32051	566	39094	343	83119	581
7186	578	12253	100	31582	150	32052	566	39095	342	83132	581
7188	579	12254	101	31588	157	32053	566	39099	340	83153	570
9228	858	12255	110	31589	146	32428	758	39101	340	83154	571
9229	858	12256	110	31592	150	32429	758	39102	341	83155	570
9230	859	12257	110	31594	159	32431	758	39103	340	83156	571
9232	859	12258	111	31595	149	32432	759	39113	344	83157	572
12221	106	30658	608	31596	153	32433	759	39114	344	83159	572
12222	106	30659	608	31599	185	32765	716	43637	513	83162	572
12223	106	30832	748	31601	180	32766	716	80263	577	83163	573
12224	107	30833	749	31602	189	32767	716	80264	577	83404	568
12225	107	30834	749	31603	191	33168	683	80265	578	83406	672
12226	102	30835	749	31605	185	33169	682	81262	776	84028	581
12227	102	30931	522	31606	180	33171	682	81265	777	85104	820
12228	102	31001	738	31607	189	33172	682	81635	568	85261	278
12229	103	31002	738	31608	192	33184	760	81636	568	85262	278
12231	103	31003	739	31611	184	33185	760	81827	823	85263	279
12232	103	31004	738	31613	188	33186	760	81828	823	85264	279
12233	104	31005	740	31614	191	33187	761	82305	821	85832	673
12234	104	31006	741	31616	184	33344	444	82741	582	85856	304
12235	104	31007	741	31618	188	33345	442	82747	303	85857	304
12236	105	31008	741	31627	186	33677	623	82748	302	85858	305
12237	105	31571	156	31629	190	33678	623	82749	302	85859	304
12239	105	31572	146	31631	192	33682	636	82751	303	85971	804
12241	108	31573	151	31666	465	33941	608	82752	303	85974	804
12242	108	31574	155	31667	385	33942	609	82785	471	85977	296
12243	108	31575	157	31995	331	33964	609	82842	800	85978	296
12244	109	31576	147	31996	331	33984	286	82843	800	85979	296

NUMBER NUMMER NUMÉRO	PAGE SEITE PAGE	NUMBER NUMMER NUMÉRO	PAGE SEITE PAGE	NUMBER NUMMER NUMÉRO	PAGE SEITE PAGE	NUMBER NUMMER NUMÉRO	PAGE SEITE PAGE	NUMBER NUMMER NUMÉRO	PAGE SEITE PAGE	NUMBER NUMMER NUMÉRO	PAGE SEITE PAGE
85981	297	89832	294	91433	300	92743	298	93836	377	94605	462
85982	297	89833	295	91496	466	92761	382	93874	803	94606	462
86712	582	89834	294	91589	279	92762	382	93875	802	94609	764
86715	583	89835	294	91971	299	92872	860	93876	802	94612	663
86811	283	89836	295	92084	746	92873	860	93877	802	94613	663
86812	283	90043	580	92085	746	92924	778	93901	836	94617	657
86813	284	90304	290	92086	746	92925	778	93917	800	94626	630
86814	284	90305	290	92087	747	92933	779	93952	143	94635	224
86815	284	90697	584	92143	584	92935	778	93965	838	94636	224
86817	282	90737	584	92146	867	93003	295	93966	838	94673	846
87008	468	90872	857	92147	867	93046	809	94244	391	94677	846
87009	468	90873	857	92206	791	93073	386	94245	391	94697	855
87054	466	90874	857	92251	421	93076	848	94252	739	94698	799
87055	465	90914	754	92252	420	93077	848	94319	380	94699	854
87219	672	90915	754	92288	881	93078	846	94329	777	94702	854
87222	672	90916	754	92348	882	93085	764	94377	379	94704	855
87254	820	90917	755	92563	299	93358	765	94378	379	94705	799
87256	820	90927	755	92595	756	93359	764	94388	421	94712	660
87284	866	90967	856	92596	756	93373	446	94389	420	94713	660
87793	583	90977	858	92597	756	93374	446	94513	814	94714	660
88472	728	90978	469	92598	757	93397	142	94547	512	94716	657
88473	728	90982	731	92599	757	93468	466	94548	512	94764	225
88474	729	90984	730	92641	762	93625	384	94584	735	94765	225
88475	729	90985	730	92642	762	93626	384	94585	734	94878	624
88968	881	90986	730	92643	762	93679	753	94586	734	94879	624
88969	881	91002	301	92644	763	93706	875	94587	734	94884	632
89115	583	91004	300	92645	763	93707	875	94589	376	94918	157
89238	577	91006	301	92727	522	93708	387	94591	376	94919	148
89239	576	91238	821	92741	298	93709	386	94592	378	94921	151
89248	576	91242	823	92742	298	93784	387	94593	378	94924	158

NUMBER NUMMER NUMÉRO	PAGE SEITE PAGE	NUMBER NUMMER NUMÉRO	PAGE SEITE PAGE	NUMBER NUMMER NUMÉRO	PAGE SEITE PAGE	NUMBER NUMMER NUMÉRO	PAGE SEITE PAGE	NUMBER NUMMER NUMÉRO	PAGE SEITE PAGE	NUMBER NUMMER NUMÉRO	PAGE SEITE PAGE
94925	148	95257	225	95569	324	95789	807	96117	575	96437	843
94926	152	95261	224	95591	221	95824	763	96178	766	96438	842
94935	459	95282	636	95597	220	95912	389	96179	766	96439	843
94936	459	95283	637	95598	221	95913	388	96181	767	96474	471
94938	462	95284	523	95602	220	95914	389	96182	766	96477	158
94958	751	95285	523	95606	221	95993	622	96183	767	96478	148
94959	751	95286	383	95629	770	95994	622	96193	226	96479	152
94961	751	95287	383	95631	771	95995	622	96194	226	96481	155
94962	750	95364	602	95632	771	96023	550	96195	226	96483	161
94963	752	95368	601	95639	523	96032	548	96199	227	96484	160
94964	752	95371	602	95655	526	96033	548	96201	227	96528	380
94965	753	95373	603	95656	526	96034	548	96211	222	96538	143
94966	752	95377	601	95657	527	96037	610	96214	223	96539	143
94973	569	95379	602	95659	527	96038	610	96229	632	96541	648
94987	673	95383	447	95661	527	96039	613	96257	222	96542	648
94995	205	95385	447	95672	580	96041	613	96258	223	96543	649
94998	635	95386	808	95679	549	96042	611	96261	600	96544	648
94999	635	95482	736	95682	549	96043	611	96264	600	96552	722
95045	160	95483	736	95684	549	96048	595	96305	333	96553	723
95055	190	95484	737	95686	790	96049	595	96306	335	96554	723
95118	158	95485	736	95689	529	96064	668	96308	332	96555	723
95119	153	95522	410	95694	850	96065	668	96326	332	96566	589
95147	328	95523	410	95695	851	96066	668	96327	332	96567	589
95164	159	95525	411	95696	851	96073	471	96329	331	96773	364
95166	153	95526	411	95725	806	96081	874	96331	333	96774	364
95167	149	95539	788	95726	806	96089	575	96332	333	96866	329
95169	186	95541	788	95755	461	96102	324	96343	365	96937	663
95171	190	95545	719	95775	822	96103	325	96344	365	96957	852
95172	193	95546	719	95776	822	96104	324	96345	365	96981	449
95173	181	95547	719	95785	821	96105	325	96434	842	96982	449
95192	205	95567	329	95787	807	96106	325	96435	842	96983	449
95194	205	95568	329	95788	807	96111	575	96436	843	96985	451

NUMBER NUMMER NUMÉRO	PAGE SEITE PAGE	NUMBER NUMMER NUMÉRO	PAGE SEITE PAGE	NUMBER NUMMER NUMÉRO	PAGE SEITE PAGE	NUMBER NUMMER NUMÉRO	PAGE SEITE PAGE	NUMBER NUMMER NUMÉRO	PAGE SEITE PAGE	NUMBER NUMMER NUMÉRO	PAGE SEITE PAGE
96986	451	97542	533	97652	293	97871	534	98112	684	98323	542
97044	837	97543	533	97653	292	97872	534	98113	684	98324	542
97045	837	97571	873	97655	293	97873	534	98114	684	98325	553
97054	626	97572	872	97667	867	97874	538	98134	706	98326	553
97055	626	97573	872	97682	195	97875	538	98135	706	98331	508
97056	626	97574	872	97683	195	97876	538	98136	707	98332	508
97059	670	97577	541	97684	194	97877	536	98137	706	98333	508
97066	422	97578	541	97685	194	97878	536	98201	127	98334	509
97077	776	97583	271	97699	624	97879	536	98203	127	98346	400
97078	851	97584	271	97718	650	97881	540	98205	126	98347	400
97081	664	97587	381	97719	650	97882	540	98206	126	98353	441
97082	664	97589	813	97731	506	97883	541	98207	124	98379	604
97083	664	97604	406	97733	405	97884	631	98208	124	98384	367
97361	335	97605	406	97734	405	97885	632	98209	124	98386	795
97362	335	97611	138	97737	542	97886	586	98212	128	98387	795
97366	392	97612	141	97773	810	97895	507	98236	123	98393	720
97367	392	97613	139	97774	810	97904	507	98237	123	98394	720
97368	392	97614	140	97777	136	97914	840	98247	830	98395	721
97479	144	97615	138	97778	136	97915	840	98263	589	98396	720
97487	529	97616	141	97779	136	97965	628	98277	882	98397	725
97506	745	97617	139	97783	137	97966	629	98279	882	98398	724
97507	745	97618	140	97784	137	98016	402	98292	128	98399	725
97508	745	97619	138	97793	381	98017	402	98293	128	98408	725
97516	809	97621	141	97806	792	98023	531	98294	123	98409	144
97526	532	97641	162	97838	144	98034	502	98297	126	98421	598
97527	532	97642	163	97839	292	98035	503	98309	791	98422	598
97528	532	97643	162	97841	442	98056	394	98311	171	98423	598
97531	630	97644	162	97845	442	98057	394	98313	171	98424	599
97536	691	97645	164	97846	443	98058	394	98314	171	98425	599
97537	691	97646	164	97854	445	98071	441	98317	500	98426	599
97538	691	97647	164	97855	445	98093	830	98318	500	98446	535
97541	533	97651	292	97857	445	98111	685	98319	500	98447	539

NUMBER NUMMER NUMÉRO	PAGE SEITE PAGE	NUMBER NUMMER NUMÉRO	PAGE SEITE PAGE	NUMBER NUMMER NUMÉRO	PAGE SEITE PAGE	NUMBER NUMMER NUMÉRO	PAGE SEITE PAGE	NUMBER NUMMER NUMÉRO	PAGE SEITE PAGE	NUMBER NUMMER NUMÉRO	PAGE SEITE PAGE
98448	537	98614	358	98735	464	98862	494	99076	700	99266	644
98449	540	98615	358	98752	287	98863	494	99077	232	99267	644
98487	531	98616	358	98753	287	98864	816	99078	232	99268	646
98488	531	98617	359	98754	287	98874	306	99079	232	99269	646
98492	414	98621	704	98755	604	98875	306	99086	594	99271	646
98495	414	98622	704	98759	604	98876	306	99087	594	99272	166
98501	670	98623	704	98762	714	98877	307	99093	275	99273	166
98502	670	98624	692	98763	714	98878	307	99094	275	99274	166
98507	501	98625	692	98764	714	98881	503	99095	275	99275	169
98514	520	98626	692	98831	844	98882	503	99096	274	99276	690
98523	372	98628	388	98832	844	98887	822	99097	274	99277	690
98524	372	98629	388	98834	403	98888	610	99098	274	99278	690
98525	373	98647	360	98835	403	98889	334	99099	21	99279	169
98526	372	98648	361	98836	415	98891	122	99106	21	99286	289
98527	530	98649	360	98837	815	98892	122	99113	796	99287	289
98541	596	98651	362	98838	435	98893	122	99122	620	99288	289
98542	596	98652	362	98839	435	98894	120	99123	620	99292	238
98543	596	98653	363	98841	593	98895	120	99124	620	99293	238
98544	597	98654	363	98842	77	98896	120	99202	638	99294	238
98545	597	98661	399	98843	83	98907	667	99203	638	99295	239
98582	361	98662	399	98844	79	98908	666	99204	641	99296	239
98585	361	98663	399	98845	84	98909	400	99205	640	99297	669
98587	204	98677	666	98846	80	99019	852	99206	638	99314	353
98588	204	98685	530	98847	86	99042	182	99207	639	99315	326
98591	454	98689	422	98849	82	99043	182	99208	640	99316	326
98592	454	98694	370	98852	85	99045	182	99209	640	99317	326
98595	377	98695	371	98854	86	99046	183	99211	643	99318	327
98596	378	98696	370	98855	844	99052	694	99212	642	99319	327
98601	555	98697	370	98856	845	99053	694	99213	642	99321	330
98602	555	98698	371	98858	405	99054	694	99214	642	99322	330
98603	554	98699	371	98859	813	99074	700	99249	418	99323	330
98604	555	98734	464	98861	494	99075	700	99265	644	99324	524

NUMBER NUMMER NUMÉRO	PAGE SEITE PAGE	NUMBER NUMMER NUMÉRO	PAGE SEITE PAGE	NUMBER NUMMER NUMÉRO	PAGE SEITE PAGE	NUMBER NUMMER NUMÉRO	PAGE SEITE PAGE	NUMBER NUMMER NUMÉRO	PAGE SEITE PAGE	NUMBER NUMMER NUMÉRO	PAGE SEITE PAGE
99325	524	99447	196	99541	189	99606	614	99661	430	99698	419
99327	525	99457	241	99542	192	99607	614	99662	430	99699	553
99328	524	99463	413	99543	180	99608	615	99663	461	99701	453
99329	808	99464	412	99544	246	99609	614	99664	505	99702	453
99331	808	99466	243	99545	246	99611	201	99665	431	99703	563
99332	809	99467	242	99546	247	99612	200	99666	431	99704	563
99334	848	99468	242	99547	247	99613	172	99667	518	99705	426
99335	849	99469	243	99548	74	99614	350	99669	95	99706	426
99339	659	99486	200	99549	74	99615	350	99671	95	99707	426
99343	547	99487	200	99551	252	99616	350	99672	95	99711	696
99344	547	99488	686	99552	252	99617	351	99673	94	99712	696
99345	254	99489	686	99553	252	99618	428	99674	94	99713	696
99346	254	99491	686	99554	253	99619	428	99675	94	99715	799
99347	255	99492	687	99555	253	99621	559	99676	45	99731	666
99348	586	99506	255	99559	334	99622	559	99677	45	99772	674
99353	241	99507	255	99561	311	99623	559	99678	34	99773	674
99358	316	99508	145	99562	310	99624	240	99679	34	99774	674
99366	368	99509	145	99563	311	99625	242	99681	34	99776	658
99367	368	99511	248	99564	311	99628	375	99682	35	99777	658
99368	368	99512	248	99591	269	99629	375	99683	35	99778	658
99371	367	99513	248	99592	269	99631	286	99684	98	99779	556
99395	483	99517	698	99593	268	99632	286	99685	98	99781	557
99397	567	99518	698	99594	269	99633	425	99686	99	99782	556
99398	567	99519	698	99595	590	99634	424	99687	99	99783	556
99406	554	99523	174	99596	591	99635	424	99689	593	99784	486
99407	554	99524	172	99597	825	99636	424	99691	651	99785	486
99408	240	99525	172	99599	414	99639	74	99692	650	99786	486
99413	240	99526	174	99601	38	99651	374	99693	432	99787	485
99438	440	99527	174	99602	38	99654	374	99694	432	99788	484
99439	440	99531	409	99603	38	99655	496	99695	433	99789	485
99445	196	99532	409	99604	39	99656	496	99696	433	99791	487
99446	196	99539	186	99605	39	99659	493	99697	419	99792	485

NUMBER NUMMER NUMÉRO	PAGE SEITE PAGE	NUMBER NUMMER NUMÉRO	PAGE SEITE PAGE	NUMBER NUMMER NUMÉRO	PAGE SEITE PAGE	NUMBER NUMMER NUMÉRO	PAGE SEITE PAGE	NUMBER NUMMER NUMÉRO	PAGE SEITE PAGE	NUMBER NUMMER NUMÉRO	PAGE SEITE PAGE
99793	492	99855	234	900071	37	900113	78	900169	726	900325	594
99794	825	99856	234	900072	37	900114	84	900171	726	900328	490
99795	234	900001	88	900076	41	900115	84	900172	727	900329	490
99796	236	900002	88	900077	41	900116	21	900173	726	900331	744
99797	236	900005	90	900078	41	900128	91	900174	417	900332	744
99798	236	900006	90	900079	40	900129	91	900175	417	900333	744
99799	322	900019	44	900081	40	900134	793	900176	265	900334	813
99801	322	900021	44	900082	40	900135	793	900177	264	900335	550
99802	322	900022	63	900083	90	900141	819	900178	265	900336	92
99803	323	900023	63	900084	88	900142	819	900179	265	900337	92
99804	323	900024	63	900085	89	900143	436	900185	521	900338	92
99805	323	900025	62	900086	54	900144	176	900186	452	900339	93
99806	262	900044	70	900087	55	900145	176	900187	788	900341	288
99807	262	900045	70	900088	54	900146	176	900188	518	900342	288
99808	263	900046	70	900089	54	900147	177	900195	353	900343	606
99809	262	900047	71	900091	57	900148	177	900196	353	900346	439
99811	403	900048	71	900092	56	900149	550	900302	506	900347	202
99817	490	900049	72	900093	56	900151	210	900304	277	900348	202
99818	418	900051	72	900094	56	900152	210	900305	276	900349	235
99819	413	900052	72	900095	73	900153	210	900306	277	900351	308
99821	413	900053	73	900099	76	900154	211	900307	277	900352	308
99822	796	900054	64	900101	76	900157	519	900313	454	900353	308
99824	812	900055	64	900102	76	900158	437	900314	814	900354	309
99825	812	900056	64	900103	82	900159	437	900315	46	900355	510
99828	831	900057	66	900104	82	900161	448	900316	46	900356	510
99829	831	900058	66	900105	80	900162	448	900317	46	900357	510
99831	832	900059	66	900106	80	900163	448	900318	47	900358	815
99832	832	900061	67	900107	81	900164	254	900319	49	900359	512
99838	676	900062	67	900108	86	900165	260	900321	49	900361	520
99839	676	900067	36	900109	87	900166	260	900322	48	900362	457
99853	676	900068	36	900111	78	900167	260	900323	48	900363	631
99854	677	900069	36	900112	78	900168	261	900324	48	900364	633

NUMBER NUMMER NUMÉRO	PAGE SEITE PAGE	NUMBER NUMMER NUMÉRO	PAGE SEITE PAGE	NUMBER NUMMER NUMÉRO	PAGE SEITE PAGE	NUMBER NUMMER NUMÉRO	PAGE SEITE PAGE	NUMBER NUMMER NUMÉRO	PAGE SEITE PAGE	NUMBER NUMMER NUMÉRO	PAGE SEITE PAGE
900365	635	900409	52	900465	320	900503	212	900561	499	900626	833
900366	634	900411	53	900466	320	900504	213	900562	313	900628	833
900367	502	900412	53	900467	320	900505	213	900563	312	900631	316
900369	636	900419	483	900468	321	900506	355	900564	313	900632	316
900375	605	900421	488	900469	321	900507	355	900565	313	900633	317
900376	203	900422	489	900471	482	900508	355	900566	51	900634	178
900377	203	900423	489	900472	417	900509	509	900567	50	900635	178
900378	203	900424	489	900475	653	900511	280	900571	498	900636	89
900379	456	900425	436	900476	654	900512	280	900572	498	900661	713
900381	456	900426	436	900477	53	900513	768	900573	498	900662	713
900382	709	900428	621	900478	42	900514	769	900596	482	900663	713
900383	709	900429	434	900479	42	900515	769	900597	482	900686	257
900384	709	900431	434	900481	58	900516	768	900598	543	900687	258
900385	217	900432	689	900482	60	900517	606	900599	543	900693	710
900386	217	900433	689	900483	58	900518	606	900601	564	900694	710
900387	24	900434	689	900484	58	900519	257	900602	565	900695	710
900388	24	900435	517	900485	60	900521	259	900603	492	900696	458
900391	24	900436	743	900486	59	900522	257	900604	492	900697	458
900392	25	900437	743	900487	59	900523	259	900605	546	900701	161
900393	792	900438	743	900488	244	900524	507	900606	546	900702	26
900394	792	900439	30	900489	244	900525	592	900607	544	900711	703
900395	280	900441	30	900491	244	900526	592	900608	544	900712	703
900396	815	900442	30	900492	245	900528	839	900609	545	900713	703
900398	42	900443	517	900493	245	900529	839	900611	545	900714	733
900399	404	900444	453	900494	256	900549	354	900612	551	900715	733
900401	408	900446	452	900495	256	900551	354	900613	551	900716	733
900402	408	900457	786	900496	258	900552	817	900614	519	900717	593
900403	816	900458	787	900497	259	900553	514	900615	655	900721	505
900404	43	900459	786	900498	552	900554	514	900616	654	900722	33
900406	31	900461	786	900499	552	900555	514	900617	656	900723	33
900407	31	900463	561	900501	552	900558	499	900618	656	900724	33
900408	52	900464	561	900502	212	900559	499	900619	631	900728	50

NUMBER NUMMER NUMÉRO	PAGE SEITE PAGE	NUMBER NUMMER NUMÉRO	PAGE SEITE PAGE	NUMBER NUMMER NUMÉRO	PAGE SEITE PAGE	NUMBER NUMMER NUMÉRO	PAGE SEITE PAGE
900729	50	900826	521	900865	519	900909	250
900731	266	900828	420	900866	429	900916	315
900732	266	900829	421	900867	429	900917	314
900733	267	900831	216	900868	794	900918	315
900734	267	900832	216	900869	794	900919	315
900735	267	900833	457	900871	595	900923	785
900736	515	900834	457	900872	270	900924	785
900738	215	900835	438	900873	270	900925	785
900739	214	900836	438	900874	273	900926	251
900741	215	900837	516	900875	272	900928	653
900742	215	900838	516	900876	272	900929	653
900758	69	900839	769	900877	273	900945	818
900759	69	900841	27	900878	23	900946	818
900761	69	900842	27	900879	23	900947	319
900762	68	900843	268	900881	27	900948	318
900763	96	900844	629	900882	26	900949	319
900764	97	900845	629	900883	26	900951	318
900765	96	900846	634	900892	241	900952	480
900766	97	900847	220	900893	357	900953	481
900792	505	900848	515	900894	357	900954	481
900795	560	900849	461	900895	385	900955	481
900796	560	900853	28	900896	423	900956	834
900797	562	900854	29	900897	423	900957	834
900798	397	900855	28	900898	817	900958	834
900799	397	900856	29	900901	219	900975	407
900801	397	900857	562	900902	219	900976	407
900812	356	900858	199	900903	219	900977	407
900813	356	900859	199	900904	218	901015	319
900814	817	900861	198	900905	218		
900823	811	900862	199	900906	251		
900824	811	900863	565	900907	250		
900825	521	900864	565	900908	250		



NOTES

NOTIZEN

NOTES

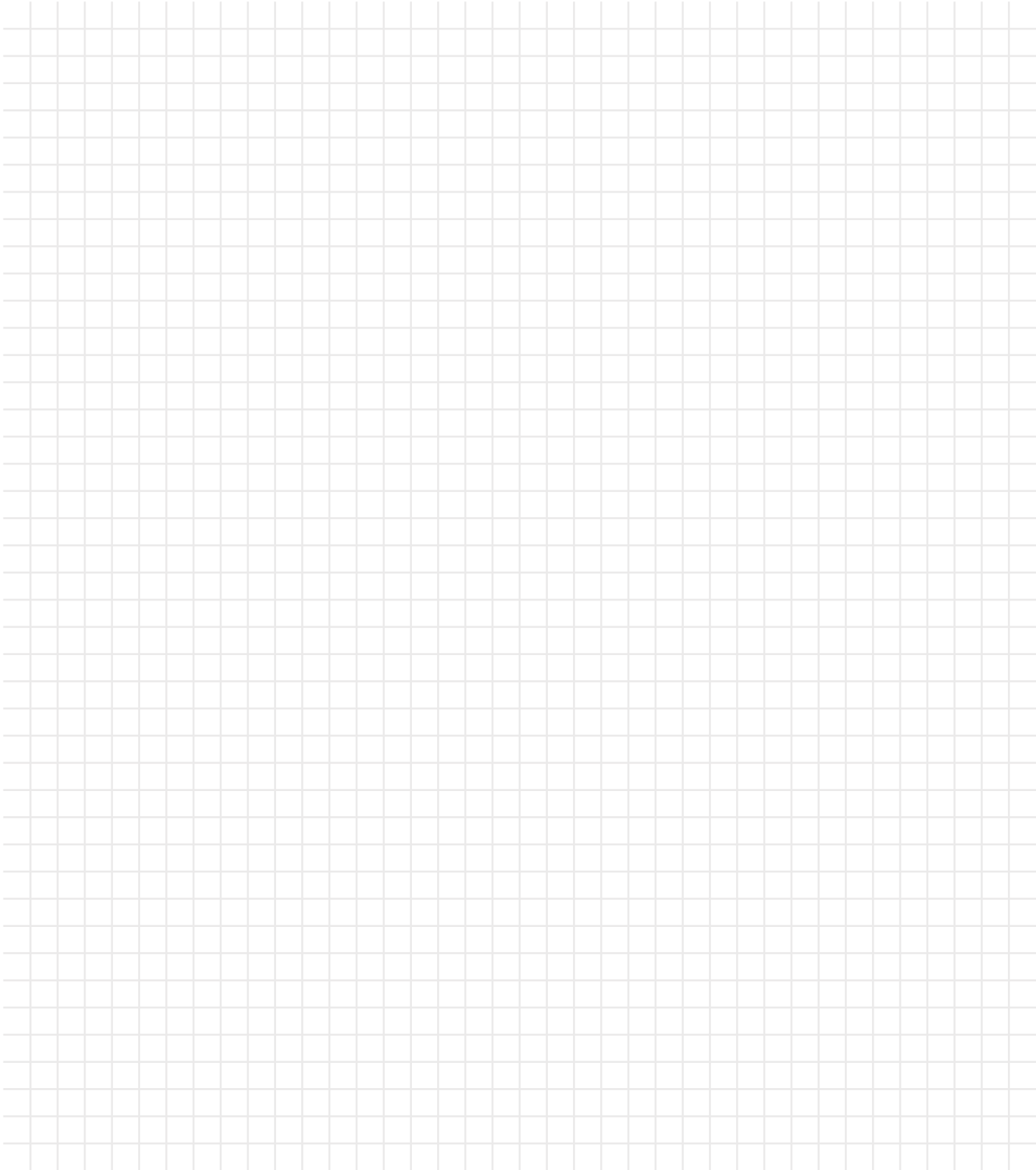

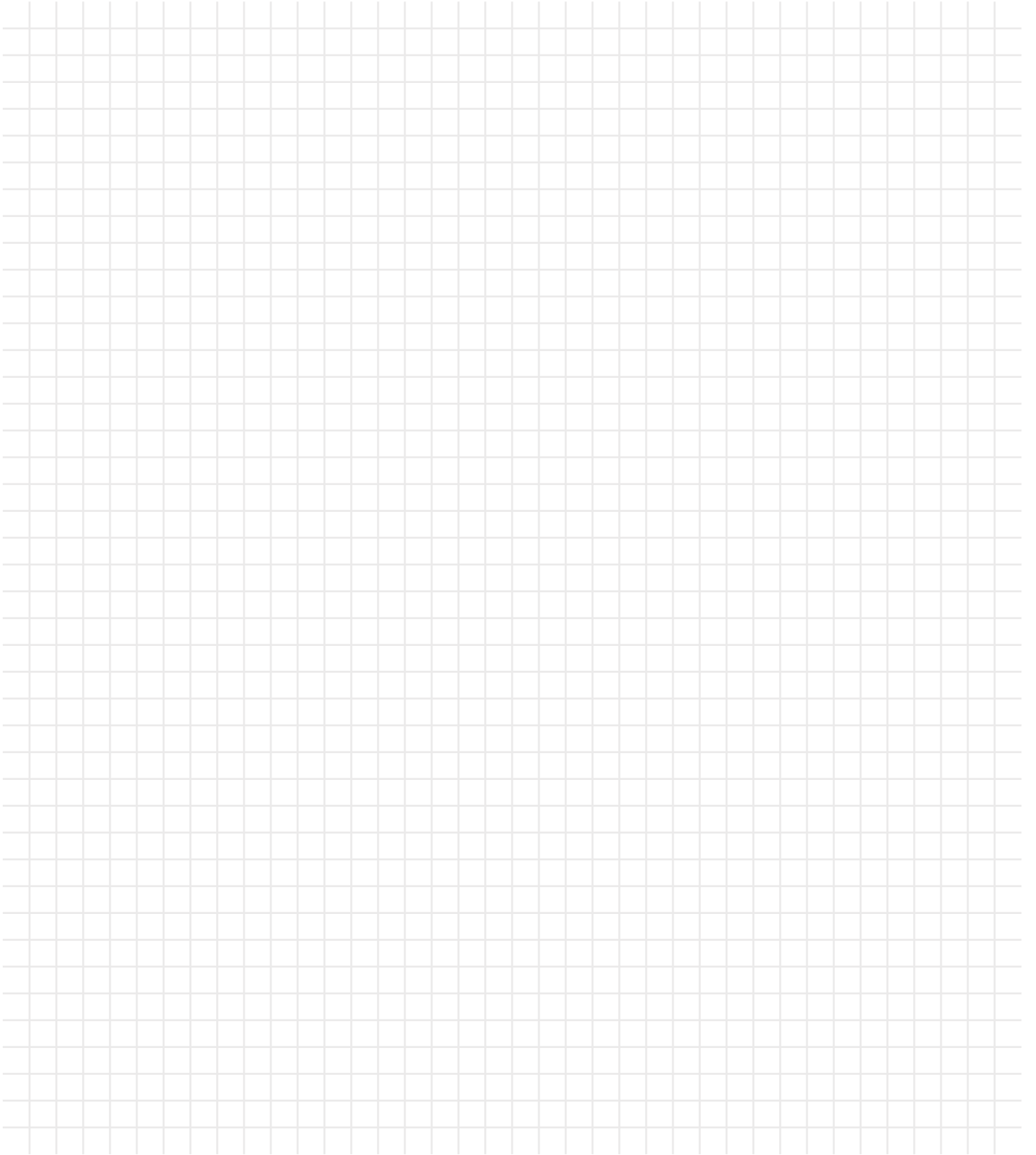

All previous catalogues and price lists are no longer valid with the issue of this catalogue. Errors, misprints, model and price changes and technical modifications are reserved. We deliver based on our terms of delivery and payment. Our products comply with the European light norm EN60598. Products with the ENEC test mark are conforming to the guide line 2006/95/EG. Products with additional safety remarks (e.g protection class, IP) are identified within the product family with the relevant symbol and number. The content of this catalogue is protected under copyright law for EGLO Leuchten GmbH. All rights reserved. Our specific written consent must be obtained before using any illustrations and texts. The pictures are 4C prints and may differ from the original. The product pictures and ambiances in this catalogue can deviate from reality, and they do not necessarily concur with the usual application of the product. EGLO does not assume liability for the correctness, completeness or the application depiction of the products and/or the product information. Design, layout and composition: EGLO GmbH, A-6136 Pill - AUSTRIA Print: Samson Druck GmbH, 5581 St. Margarethen - AUSTRIA Pictures: EGLO, Adobe Stock, istockphoto.com

Mit diesem Katalog verlieren alle vorhergehenden Kataloge und Preislisten ihre Gültigkeit. Irrtümer, Druckfehler, Modell- und Preisänderungen sowie technische Änderungen vorbehalten. Wir liefern zu unseren Liefer- und Zahlungsbedingungen. Unsere Produkte entsprechen der europäischen Leuchtnorm EN 60598. Produkte mit dem ENEC Prüfzeichen sind konform mit der Richtlinie 2006/95/EG. Produkte mit weiteren Sicherheitshinweisen (zB. Schutzklasse, IP) sind mit Symbol und Zahl bei der Produktfamilie ausgezeichnet. Der Inhalt dieses Kataloges ist für die EGLO Leuchten GmbH urheberrechtlich geschützt. Alle Rechte sind vorbehalten. Bilder und Texte dürfen nicht ohne vorherige ausdrückliche, schriftliche Genehmigung verwendet werden. Die Abbildungen sind 4C Drucke und können vom Original abweichen. Die Katalogbilder und die gezeigten Darstellungen der Produkte können von der Wirklichkeit abweichen und nicht den üblichen Produktanwendungen entsprechen. EGLO übernimmt keine Haftung für die Richtigkeit, Vollständigkeit und Anwendungsdarstellung der Produkte und Produktinformationen. Gestaltung, Layout und Satz: EGLO GmbH, A-6136 Pill - AUSTRIA Druck: Samson Druck GmbH, 5581 St. Margarethen - AUSTRIA Bilder: EGLO, Adobe Stock, istockphoto.com

Le présent catalogue remplace tous les catalogues et tarifs précédents. Sous réserve d'erreurs, de fautes d'impression, de modification des modèles et de changement de prix et de technique. Nous livrons sur la base de nos conditions de livraison et de paiement. Nos produits sont conformes aux normes européennes EN 60598 et portent le marquage CE. Les produits portant la marque ENEC sont conformes à la Directive 2006/95/EG. Les produits portant d'autres indications de sécurité (par exemple classe de protection, IP) sont identifiés par le symbole et le nombre correspondants dans la famille de produits. Le contenu du présent catalogue est protégé pour la société EGLO Leuchten GmbH par un copyright. Tous droits réservés. Toute reproduction d'images et du texte est interdite sans autorisation explicite par écrit préalable. Les images sont imprimées en 4C et peuvent différer de l'original. Les images des produits et les ambiances dans le catalogue peuvent dévier de la réalité et ne sont pas nécessairement en ligne avec l'usage habituel du produit. EGLO n'engage pas sa responsabilité sur la justesse des images et sur les informations relatives à l'usage pouvant être fait des produits. Conception, maquette et composition: EGLO GmbH, A-6136 Pill - AUSTRIA Presse: Samson Druck GmbH, 5581 St. Margarethen - AUSTRIA Images: EGLO, Adobe Stock, istockphoto.com

06-2023



EGLO Leuchten GmbH
Heiligkreuz 22
A-6136 Pill
Austria
Tel. +43 (0) 5242 6996
Fax +43 (0) 5242 6996-972
info@eglo.com
www.eglo.com

KAT-23

my light | my style